

SOURCES, EFFECTS AND RISKS OF IONIZING RADIATION

# UNSCEAR **2016 Report**

## Report to the General Assembly

SCIENTIFIC ANNEXES A, B, C and D





# SOURCES, EFFECTS AND RISKS OF IONIZING RADIATION

United Nations Scientific Committee on the  
Effects of Atomic Radiation

UNSCEAR 2016  
Report to the General Assembly,  
with Scientific Annexes



UNITED NATIONS  
New York, 2017

#### NOTE

The report of the Committee without its annexes appears as *Official Records of the General Assembly*, Seventy-first Session, Supplement No. 46 and corrigendum (A/71/46 and Corr.1). The report reproduced here includes the corrections of the corrigendum.

The designations employed and the presentation of material in this publication do not imply the expression of any opinion whatsoever on the part of the Secretariat of the United Nations concerning the legal status of any country, territory, city or area, or of its authorities, or concerning the delimitation of its frontiers or boundaries.

The country names used in this document are, in most cases, those that were in use at the time the data were collected or the text prepared. In other cases, however, the names have been updated, where this was possible and appropriate, to reflect political changes.

UNITED NATIONS PUBLICATION  
Sales No. E.17.IX.1  
ISBN: 978-92-1-142316-7  
eISBN: 978-92-1-060002-6

© United Nations, January 2017. All rights reserved, worldwide.

This publication has not been formally edited.

Information on uniform resource locators and links to Internet sites contained in the present publication are provided for the convenience of the reader and are correct at the time of issue. The United Nations takes no responsibility for the continued accuracy of that information or for the content of any external website.

## CONTENTS

Report of the United Nations Scientific Committee on the Effects of Atomic Radiation to the General Assembly .....	<i>Page</i> 1
---	------------------

### **Scientific Annexes**

Annex A. Methodology for estimating public exposures due to radioactive discharges.....	19
Annex B. Radiation exposures from electricity generation .....	135
Annex C. Biological effects of selected internal emitters—Tritium .....	241
Annex D. Biological effects of selected internal emitters—Uranium .....	361



# Report of the United Nations Scientific Committee on the Effects of Atomic Radiation to the General Assembly

## Contents

<i>Chapter</i>	<i>Page</i>
I. Introduction . . . . .	1
II. Deliberations of the United Nations Scientific Committee on the Effects of Atomic Radiation at its sixty-third session . . . . .	2
A. Completed evaluations . . . . .	2
B. Present programme of work . . . . .	3
1. Developments since the Committee's 2013 report on the levels and effects of radiation exposure due to the nuclear accident following the great east-Japan earthquake and tsunami . . . . .	3
2. Cancer epidemiology of exposures at low dose-rates due to environmental radiation . . . . .	4
3. Selected evaluations of health effects and risk inference from radiation exposure . . . . .	4
4. Collection of data on radiation exposures, in particular on medical and occupational exposures . . . . .	4
5. Outreach activities . . . . .	5
C. Long-term strategic directions . . . . .	6
D. Future programme of work . . . . .	7
E. Administrative issues . . . . .	8
III. Scientific report . . . . .	9
A. Methodology for estimating public exposures due to radioactive discharges . . . . .	9
B. Radiation exposures from electricity generation . . . . .	10
C. Biological effects of selected internal emitters . . . . .	13
<b>Appendices</b>	
I. Members of national delegations attending the fifty-seventh to sixty-third sessions of the United Nations Scientific Committee on the Effects of Atomic Radiation . . . . .	16
II. Scientific staff and consultants cooperating with the United Nations Scientific Committee on the Effects of Atomic Radiation in the preparation of its scientific report for 2016 . . . . .	18





## Chapter I

### Introduction

1. Since the establishment of the United Nations Scientific Committee on the Effects of Atomic Radiation by the General Assembly in its resolution 913 (X) of 3 December 1955, the mandate of the Committee has been to undertake broad assessments of the sources of ionizing radiation and its effects on human health and the environment.<sup>1</sup> In pursuit of its mandate, the Committee thoroughly reviews and evaluates global and regional exposures to radiation. The Committee also evaluates evidence of radiation-induced health effects in exposed groups and advances in the understanding of the biological mechanisms by which radiation-induced effects on human health or on non-human biota can occur. Those assessments provide the scientific foundation used, inter alia, by the relevant agencies of the United Nations system in formulating international standards for the protection of the general public, workers and patients against ionizing radiation;<sup>2</sup> those standards, in turn, are linked to important legal and regulatory instruments.

2. Exposure to ionizing radiation arises from naturally occurring sources (such as radiation from outer space and radon gas emanating from rocks in the Earth) and from sources with an artificial origin (such as medical diagnostic and therapeutic procedures; radioactive material resulting from nuclear weapons testing; energy generation, including by means of nuclear power; unplanned events such as the nuclear power plant accidents at Chernobyl in 1986 and that following the great east-Japan earthquake and tsunami of March 2011; and workplaces where there may be increased exposure to radiation from artificial or naturally occurring sources).

---

<sup>1</sup> The United Nations Scientific Committee on the Effects of Atomic Radiation was established by the General Assembly at its tenth session, in 1955. Its terms of reference are set out in resolution 913 (X). The Committee was originally composed of the following Member States: Argentina, Australia, Belgium, Brazil, Canada, Czechoslovakia (later succeeded by Slovakia), Egypt, France, India, Japan, Mexico, Sweden, Union of Soviet Socialist Republics (later succeeded by the Russian Federation), United Kingdom of Great Britain and Northern Ireland, and United States of America. The membership of the Committee was subsequently enlarged by the Assembly in its resolution 3154 C (XXVIII) of 14 December 1973 to include the Federal Republic of Germany (later succeeded by Germany), Indonesia, Peru, Poland and the Sudan. By its resolution 41/62 B of 3 December 1986, the Assembly increased the membership of the Committee to a maximum of 21 members and invited China to become a member. In its resolution 66/70 of 9 December 2011, the Assembly further enlarged the membership of the Committee to 27 and invited Belarus, Finland, Pakistan, the Republic of Korea, Spain and Ukraine to become members.

<sup>2</sup> For example, the international basic safety standards for radiation protection and safety of radiation sources, currently co-sponsored by the European Commission, the Food and Agriculture Organization of the United Nations, the International Atomic Energy Agency, the International Labour Organization, the Nuclear Energy Agency of the Organization for Economic Cooperation and Development, the Pan American Health Organization, the United Nations Environment Programme and the World Health Organization.

## Chapter II

### **Deliberations of the United Nations Scientific Committee on the Effects of Atomic Radiation at its sixty-third session**

3. The Committee held its sixty-third session in Vienna from 27 June to 1 July 2016.<sup>3</sup> Yoshiharu Yonekura (Japan), Chair; John Hunt (Brazil), Peter Jacob (Germany) and Hans Vanmarcke (Belgium), Vice-Chairs; and Michael Waligórski (Poland), Rapporteur, served as officers of the Committee.

4. The Committee took note of General Assembly resolution 70/81 on the effects of atomic radiation. It recalled that it had expected to report its long-term strategic directions beyond the period covered by its present strategic plan (2014-2019), so as to help to inform future deliberations of the Assembly on the Committee's membership.

#### **A. Completed evaluations**

5. The Committee discussed four substantive evaluations in detail, adopted the scientific report based on the findings of those evaluations (see chapter III) and requested that the scientific annexes be published in the usual manner, subject to the agreed modifications.

6. The Committee had decided, at its fifty-sixth session, to initiate work on a new estimation of human exposures to ionizing radiation from electricity generation. Accordingly it had decided to review and update its previous methodology for estimating public exposures from discharges published in its 2000 report. The Committee discussed and approved for publication the scientific annex updating the methodology and associated electronic workbooks.

7. The Committee recalled that progress on the scientific annex on radiation exposures from electricity generation had been hampered by, among other things, gaps in data on occupational exposures and on releases associated with electricity generated from non-nuclear energy sources. In comparison, there were abundant data for the nuclear energy industry, although those data remained somewhat deficient as regards decommissioning and other aspects of the so-called back end of the nuclear fuel cycle. The evaluation has been completed on the basis of reasonable and transparent assumptions where precise data were not available. The electronic workbooks for implementing the methodology had been used in 2015 to complete, in an internally consistent manner, the assessment of radiation exposures of populations from various types of electricity generation.

8. At its fifty-sixth session, held from 10 to 18 July 2008, during deliberations on its future programme of work, the Committee had decided that work should be undertaken to address radiation doses and the risks and effects from internally deposited radionuclides. At its fifty-seventh session, held from 16 to 20 August 2010,

---

<sup>3</sup> The sixty-third session was attended by observers for the International Atomic Energy Agency, the International Labour Organization, the World Health Organization, the European Union, the International Agency for Research on Cancer, the International Commission on Radiological Protection and the International Commission on Radiation Units and Measurements.

the Committee had further decided to focus on tritium and radioisotopes of uranium. At the current session, the Committee agreed that the review of the literature was now complete, that the material had been streamlined and its structure harmonized, and that final conclusions had been drawn from the material evaluated. The Committee accordingly approved the evaluations for publication.

## **B. Present programme of work**

### **1. Developments since the Committee's 2013 report on the levels and effects of radiation exposure due to the nuclear accident following the great east-Japan earthquake and tsunami**

9. The Committee recalled its assessment of the exposures and effects due to the nuclear accident after the 2011 great east-Japan earthquake and tsunami, as presented in its report to the sixty-eighth General Assembly in 2013 (A/68/46) and the supporting detailed scientific annex.<sup>4</sup> It had concluded in that report that, in general, doses were low and that therefore associated risks were also likely to be low. Cancer rates were expected to remain stable. Nevertheless, in the report the Committee had noted a possibility that the risk of thyroid cancer among those children most exposed to radiation could increase. However, it also noted that the likelihood of a large number of radiation-induced thyroid cancers in Fukushima Prefecture — such as after the Chernobyl accident — could be discounted because absorbed doses to the thyroid after the Fukushima accident were substantially lower. It had concluded that no discernible changes in the incidence of birth defects and hereditary disease were expected, and that the effects on terrestrial and marine ecosystems would be transient and localized. Cancer rates for workers were expected to remain stable.

10. Following its assessment, the Committee put in place arrangements for follow-up activities to enable it to remain abreast of additional relevant information as it was published. The Committee's report of its sixty-second session to the seventieth General Assembly included the findings from the follow-up activities it had conducted up to that time.

11. The Committee continued to identify further information that had become available up to the end of 2015, and systematically appraised relevant new publications to assess their implications for its 2013 report. A notable publication was the report by the International Atomic Energy Agency (IAEA) on the accident at the Fukushima Daiichi nuclear power station.<sup>5</sup> It describes the accident and its causes, evolution and consequences based on an evaluation of data and information from a large number of sources available at the time it was written. That report and a large proportion of the new publications again confirmed the main assumptions and findings in the Committee's 2013 report. None of the publications materially affected the main findings in the 2013 report or challenged its major assumptions. Several publications were identified for which further analysis or more conclusive evidence from additional research was needed. On the basis of the material reviewed, the Committee saw no need, at the current time, to make any change to its

---

<sup>4</sup> United Nations publication, Sales No. E.14.IX.1.

<sup>5</sup> International Atomic Energy Agency, *The Fukushima Daiichi Accident: Report by the Director General* (GC(59)/14), accompanied by technical volumes 1-5.

overarching conclusions. However, several of the research needs identified by the Committee had yet to be addressed fully by the scientific community.

12. The Committee plans to continue to identify and systematically appraise new information on the accident, and evaluate the outcomes periodically at its annual sessions. It also plans to actively engage with those responsible for formulating, implementing and advising on major research programmes in Japan, in order to rapidly assimilate emerging issues, and highlight questions needing further research. At an appropriate time, dependent on the outcomes, the Committee expects to consider the need to update its 2013 report.

13. The Committee requested the secretariat, subject to available resources, to publish the findings of its systematic review of new scientific literature as a non-sales publication in English and also to foster its publication in Japanese.

## **2. Cancer epidemiology of exposures at low dose-rates due to environmental radiation**

14. The Committee discussed progress on an evaluation of epidemiological studies of cancer incidence from low-dose-rate exposures due to environmental sources of radiation. The Committee acknowledged that the scientific review had improved considerably. It welcomed the development of an appendix on quality criteria for the Committee's reviews of epidemiological studies. The Committee requested that the scientific review and quality criteria now be brought into accordance with each other. It requested that the appendix be finalized for publication as an independent annex because of its wider application, and expected that both the review and quality criteria could be approved for publication at the sixty-fourth session.

## **3. Selected evaluations of health effects and risk inference from radiation exposure**

15. The Committee considered progress on evaluations of selected health effects and the inference of risk from exposure to ionizing radiation. Four scenarios were proposed for evaluation based on agreed criteria and preliminary literature reviews: leukaemia after exposure at low dose; solid cancer risk after acute and protracted exposure; thyroid cancer risk after exposure during childhood or adolescence; and risk of circulatory diseases after acute and protracted exposure. The Committee expected that the evaluations would be conducted in line with quality criteria for the Committee's reviews of epidemiological studies, and expected to discuss draft evaluations at the sixty-fourth session.

## **4. Collection of data on radiation exposures, in particular on medical and occupational exposures**

16. The Committee took note of a progress report by the secretariat on the collection, analysis and dissemination of data on radiation exposures, in particular on medical and occupational exposures. The Committee welcomed the fact that the General Assembly, in its resolution 70/81, had encouraged Member States to nominate a national contact person to facilitate coordination of the collection and submission of data on the exposure of the public, of workers and of patients. Fifty-one Member States had nominated national contact persons by the sixty-third session of the Committee.

17. In 2014, the secretariat had launched an online platform for the collection of data on medical exposures and had invited all Member States to take part in the Committee's Global Survey of Medical Radiation Usage and Exposures. In preparation for the Global Survey it had fostered close cooperation with IAEA, the World Health Organization and the International Radiation Protection Association. Twenty countries had submitted their first data on medical exposure; however, not all their submissions were complete. Because of the relatively low response rate to date, and because of delays brought about by changes in the United Nations administrative and financial platform (Umoja), the cut-off date for data submission would be extended until May 2017. The Committee requested the secretariat to prepare a first evaluation of the results for the Committee's review at its sixty-fourth session, including a detailed literature review. It also requested the secretariat to accelerate the survey on occupational exposures, fostering close cooperation with the International Labour Organization and other relevant bodies, and to begin detailed work on defining and collecting data on public exposures to radiation from natural and artificial sources.

## 5. Outreach activities

18. The Committee took note of a progress report by the secretariat on outreach activities. It acknowledged in particular the work done in Japan to disseminate the Committee's 2013 report on the levels and effects of radiation exposure due to the Fukushima Daiichi accident and the white paper on developments since that report. It noted that the General Assembly had encouraged the secretariat to continue to disseminate the findings to the public. The Committee also welcomed the outreach activities surrounding the sixtieth anniversary of the Committee's inception, the thirtieth anniversary of the Chernobyl accident, and the fifth anniversary of the nuclear accident in Japan. The updated publication of the United Nations Environment Programme (UNEP) entitled *Radiation: Effects and Sources*, which is intended as a basic scientific guide for the public, was published in English; publication in other languages is envisaged. The secretariat had also prepared a memory stick preloaded with all the Committee's publications and all the resolutions relevant to its activities, in all official languages of the United Nations where available, as a handy reference tool.

19. With regard to the sixtieth anniversary of the Committee, the Mayor and Governor of the City of Vienna hosted a reception for invited dignitaries, scientists and diplomats at the Vienna Town Hall to commemorate the anniversary. The Secretary-General of the United Nations, Ban Ki-moon, sent a video message for the occasion, in which he said: "From assessing the significance of fallout in the 1950s to evaluating the effects of radiation on the human genome today, the Committee has always taken an independent and impartial approach. This is crucial on issues that are often highly emotional and political." Other speakers delivered messages from the heads of their organizations, including the World Health Organization, IAEA, the Preparatory Commission for the Comprehensive Nuclear-Test-Ban Treaty Organization and UNEP. The messages commended the Committee for the expertise and independence shown in its scientific reviews, lauded its efforts to share its scientific findings with a broader audience and encouraged it to further enhance those efforts.

### C. Long-term strategic directions

20. The Committee considered its long-term strategic directions beyond the period covered by its present strategic plan (2014-2019). The Committee took note of the report of the Secretary-General to the General Assembly at its sixty-ninth session on the impact of the increase in the membership to 27 States, and possible approaches to further increase procedures (see A/69/350). The Committee also took note of General Assembly resolution 70/81 on the effects of atomic radiation, in which the Assembly requested the Secretary-General to provide it at its seventy-second session with a list of the Member States that had expressed their particular interest in membership in the Committee between the sixty-sixth and seventy-second sessions.

21. The Committee envisages to direct its future work mainly at the following scientific areas:

(a) Improving the evaluation of exposure levels for people in everyday life, in occupational environments, during medical procedures, and as a result of accidents;

(b) Improving the understanding of mechanisms of radiation action and biological reaction at all levels of biological organization, i.e. from the molecular level to the population level;

(c) Obtaining more definitive evidence relating to health effects, in particular health effects from low-dose-range and chronic exposure, and sound estimates of the health implications of exposure of populations to radiation.

22. The Committee also expects that rapidly emerging issues or significant events may lead to short-term or longer-term reprioritization, and the programme of work is changed accordingly at each session. As an example, in recent times the Committee redirected its efforts towards a timely scientific evaluation of the levels and effects of radiation exposure due to the 2011 nuclear accident in Japan.<sup>4</sup>

23. The Committee is of the view that it will be able to continue delivering authoritative scientific evaluations in the scientific areas outlined above. The Committee fully supports the Secretary-General's view that the primary purpose of any increase in the number of States members should be to enhance the capability of the Committee to conduct its scientific work. The Committee believes that there is a limit of about 30 States members with which the Committee's secretariat at its present size could reasonably cope while at the same time supporting the scientific work of the Committee. Any increase above that number would require further strengthening of the secretariat's human resources (see paragraphs 35 and 40 of A/69/350).

24. The Committee thus considers that any discussion of membership should focus on the Committee's ability to continue its delivery of authoritative scientific evaluations as well as on the secretariat's ability to support the Committee in doing so. However, in view of the ever-increasing scientific database it may be necessary to implement a range of strategies that will support the Committee's efforts to serve the scientific community as well as wider audiences. Such strategies may also allow for the inclusion of scientists outside the Committee's current membership. There already are examples of such arrangements, and they have proved beneficial to the

Committee's work while causing only minor or negligible additions to the workload of the secretariat.

25. While recognizing the importance of including all States members in, inter alia, the implementation of the Committee's strategies, future deliberations and the production of scientific documents, and while giving due regard to available resources, the Committee could consider including the following in the strategies referred to in the previous paragraph:

(a) Establishing standing working groups focused on areas such as sources and exposure, or health and environmental effects;

(b) Inviting, on an ad hoc basis, scientists from other States Members of the United Nations to participate in evaluations regarding the above areas;

(c) Increasing the Committee's efforts to present its evaluations, and summaries thereof, in a manner that attracts readers without compromising scientific rigour and integrity;

(d) While maintaining its lead in providing authoritative scientific evaluations to the General Assembly, liaising closely with other relevant international bodies to avoid duplication of efforts to the extent possible.

26. Over the coming sessions, the Committee will work towards implementing the above strategies.

#### **D. Future programme of work**

27. The Committee discussed preliminary plans for five projects and two smaller activities. The five topics for which projects were proposed were: (a) second cancers after radiotherapy; (b) assessment of the impact on biota of radiation exposure due to the nuclear industry; (c) biological mechanisms that may influence health effects from low-dose radiation exposure; (d) effects of exposure to radon in homes and workplaces; and (e) epidemiological studies of radiation and cancer. Having considered the current work programme and the capacity of both the Committee and its secretariat, the Committee decided:

(a) To start projects in 2016 based on topics (c) and (d), and to focus the project for topic (c) on cancer and hereditary effects;

(b) To start a project in 2017 based on the proposal for topic (e) in a version further elaborated by the delegation of the United States of America;

(c) To ask the French delegation to elaborate working material for a more in-depth discussion on the proposal for topic (a) with a view to accepting the proposal in 2017.

28. The Committee also requested the secretariat to prepare a short paper on the scientific view of the Committee on the dose and dose rate effectiveness factor, and another on the evaluation of thyroid cancer data in regions affected by the nuclear power plant accident at Chernobyl in 1986, with a view to discussion and acceptance at the sixty-fourth session of the Committee.

## **E. Administrative issues**

29. The Committee recognized that, because of the need to maintain the intensity of its work — particularly its work to develop exposure databases and to improve the dissemination of its findings to the public, including in official languages of the United Nations other than English — regular pledges to make voluntary contributions to the general trust fund established by the Executive Director of UNEP would be pivotal. The Committee suggested that the General Assembly might encourage Member States to consider making regular pledges of voluntary contributions to the general trust fund for that purpose, or to make contributions in kind.

30. The Committee agreed to hold its sixty-fourth session in Vienna from 29 May to 2 June 2017. It elected new officers to guide the Committee at its sixty-fourth and sixty-fifth sessions: Hans Vanmarcke (Belgium), Chair; Peter Jacob (Germany), Patsy Thompson (Canada), Michael Waligórski (Poland), Vice-Chairs; and Gillian Hirth (Australia), Rapporteur.



## Chapter III

### Scientific report

31. Four scientific annexes (published separately) provide the rationale for the findings set out below.

#### A. Methodology for estimating public exposures due to radioactive discharges

32. From time to time, the Committee has undertaken estimations of public exposures from radioactive discharges to the environment under normal operations, primarily from facilities in the nuclear fuel cycle. On each occasion, the Committee reviewed its methodology for estimating exposures in the light of scientific developments and, where appropriate, revised it. The Committee decided to update and extend its past evaluations of human exposures to ionizing radiation from electricity generation. Consequently, the Committee has reviewed and updated its previous methodology for estimating public exposures from discharges that had been published in its 2000 report. Because of the need to be applied more flexibly for different types of electricity generation and in the interest of transparency, the methodology was updated to provide results in terms of estimated radiation doses specific to the discharge of each significant radionuclide.

33. The updated methodology can be used to estimate characteristic individual doses and collective doses resulting from discharges to the atmosphere, rivers and lakes, and the sea. Characteristic individual doses are doses indicative of those received by a typical person living in the area around the discharge point. A collective dose is the product of the mean dose to a specified population from a particular source, and the number of people in that population, integrated over a defined period of time. In other words, a collective dose is the dose received by all members of a particular population combined, over a defined period of time. However, the calculated doses are metrics to be used only for the comparison of different sources of exposure, not to estimate implications for health. Moreover, the methodology applies only to routine discharges that can be assumed to be continuous; more sophisticated methodologies are needed to assess exposures from accidental releases.

34. Radioactive discharges can lead to exposures of the public in a number of ways, and the updated methodology takes the most important of these into account, namely exposures from radionuclides external to the body, i.e., in the atmosphere and on the ground, and exposures from radionuclides inside the body following intakes by inhalation and ingestion. To enable the estimation of exposures for both nuclear and non-nuclear forms of electricity generation, the methodology was extended to cover a wide range of radionuclides. The methodology uses models based on experimental data and other field observations in order to estimate the transfer of radionuclides through the environment and thus the resulting exposures of the public. The updated methodology now takes into account an additional route of exposure not previously considered, namely the ingestion of crops irrigated with water that contains radionuclides as a consequence of discharges to fresh water.

35. In the past, world average values for population densities and food consumption were used because those were considered sufficient to estimate global exposures from nuclear facilities. However, non-nuclear power stations are found throughout the world, and population densities and food consumption vary much more around them. Therefore the Committee has decided to include regional factors. Even so, the regions now considered are still very large, and other approaches would be necessary to make assessments for individual sites. Exposures are estimated using a series of mathematical models, for which the Committee has chosen parameter values that result in realistic exposure estimates. This is in contrast to a more cautious approach often used for regulatory purposes, whereby values are selected so as to deliberately overestimate exposures.

36. As before, estimates can still be made of collective doses to populations on a local, regional and global scale, as appropriate. In addition, the methodology provides information on collective doses resulting from a year's continuous discharge into the atmosphere to different population groups as a function of their distance from the discharge point. The estimates of collective doses to the world population are now available integrated over periods of 100, 500 and 10,000 years.

37. The methodology has been implemented in a series of electronic workbooks to provide transparency and facilitate use and revision by the Committee in any future studies. The workbooks contain information on the most important exposure pathways and radionuclides and are made available for download on the website of the Committee ([www.unscear.org](http://www.unscear.org)).

38. The Committee is satisfied that the updated methodology, as implemented in the workbooks, is robust, builds on the strong position of previous versions and is suitable for estimating exposures of regional and global populations from routine discharges of radionuclides to various environments.

## **B. Radiation exposures from electricity generation**

39. The world's mix of electricity-generating technologies changes over time in response to the landscape of climatic, environmental, resource, political and economic challenges. Governments and researchers may conduct various comparative studies that take into account, among other things, the impact of different technologies on the public, on workers and on the environment. Exposure to ionizing radiation is only one of the many factors that may be taken into account as part of such assessments. However, the Committee considers that an update and extension of its past evaluations of radiation exposures of the public and of workers from electricity generation could be a useful source of information for such studies.

40. While interest in the exposure of the public and of workers to radiation due to electricity generation from nuclear power dates back to the earliest use of the technology, radiation exposures from the use of other electricity-generating technologies have not been so comprehensively studied. The Committee has periodically reviewed exposures of both the public and of workers related to electricity generation from nuclear power, and has also conducted evaluations for other forms of electricity generation, albeit to a lesser extent.<sup>6</sup> These evaluations

---

<sup>6</sup> *Sources and Effects of Ionizing Radiation — 1977 Report to the General Assembly, with Annexes*

have used a variety of methodologies and relied on data from industrial activities outside the nuclear sector that are not generally monitored or reported in a systematic manner, which has made meaningful comparisons between the radiation exposures from the different electricity-generating technologies challenging.

41. Assessing the collective dose from accidents was out of the scope of the evaluations of radiation exposures of the public and of workers from electricity generation; however, the Committee has conducted assessments of past accidents in its 2008 report; of the Chernobyl accident in its reports of 1988, 2000 and 2008; and of the Fukushima Daiichi nuclear accident in its 2013 report. It is difficult to make direct comparisons between exposures from accidents and those resulting from routine discharges. One of the reasons is that the distribution of doses to the public immediately after an accident is much more localized geographically, whereas the collective doses from normal operations for electricity generation are more evenly distributed over regional or global populations. Nevertheless, the collective dose to the global population from serious accidents, such as those that occurred at the Chernobyl and Fukushima Daiichi nuclear power stations, were orders of magnitude larger than the collective doses to the world population from one year's normal operation of significant technologies of electricity generation, as assessed in the study.

42. As stated above, the Committee has updated its methodology for estimating public exposures due to radioactive discharges. The methodology is now more flexible to be able to address a wider range of electricity-generating technologies. In addition to including an extensive analysis of the available data, the updated methodology provides the Committee with a sounder basis for comparative studies than was possible before. In parallel, the Committee also re-evaluated occupational exposures arising from different electricity-generating technologies, using data mainly from dosimetry records of worker exposures. These evaluations comprise the basis for the current comparative study on radiation exposures of both the public and of workers from electricity generation.

43. The Committee conducted the comparative study by investigating sources of exposure from electricity-generating technologies based on nuclear power; the combustion of coal, natural gas, oil and biofuels; and geothermal, wind and solar power. Two electricity-generating technologies (nuclear power and coal combustion) were investigated in detail, because a more robust database existed for them. The Committee evaluated the main sources of radioactive discharges from their life cycle. For the life cycle of nuclear power the sources of radioactive discharges included uranium mining, milling and mill tailings, power plant operation and reprocessing activities. For the life cycle associated with the combustion of coal those sources were coal mining, the operation of coal-fired power plants (both modern and older-style), and deposits of coal ash. For the sake

---

(United Nations publication, Sales No. E.77.IX.1); *Ionizing Radiation: Sources and Biological Effects — 1982 Report to the General Assembly, with Annexes* (United Nations publication, Sales No. E.82.IX.8); *Sources, Effects and Risks of Ionizing Radiation — 1988 Report to the General Assembly, with Annexes* (United Nations publication, Sales No. E.88.IX.7); *Sources and Effects of Ionizing Radiation — 1993 Report to the General Assembly, with Scientific Annexes* (United Nations publication, Sales No. E.94.IX.2); and *Sources and Effects of Ionizing Radiation — 2000 Report to the General Assembly, with Scientific Annexes, Volume I: Sources*, (United Nations publication, Sales No. E.00.IX.3).

of simplicity we will refer to these cycles as the nuclear fuel cycle and the coal cycle, respectively.

44. To compare exposures, the Committee focused on two metrics. The first consisted of the collective doses to defined population groups resulting from one year's global and regional electricity generation by each technology, integrated over specific time periods. The second metric consisted of the relevant collective doses divided by the amount of electricity generated by each technology. The reference year used for the comparisons was 2010.

45. The Committee estimated that the contribution from the coal cycle was more than half of the total collective dose to the local and regional public from the discharges due to a single year's global electricity generation. That estimate was based on the assumption that the discharges originated from modern coal plants. The nuclear fuel cycle, on the other hand, contributed less than a fifth. The contribution from the coal cycle comes from discharges of natural radionuclides (primarily radon and its radioactive progeny) during coal mining, combustion of coal at power plants and coal ash deposits. Similarly, almost half of the exposures of the global public from the nuclear fuel cycle result from discharges of natural radionuclides during uranium mining and milling activities. These values depend on the share of each technology in total electricity production; in 2010 the coal cycle contributed about 40 per cent, the largest amount. Although radon and its progeny are relatively important contributors to the collective doses to the public for both the nuclear fuel cycle and the coal cycle, the associated individual doses are small compared with doses due to inhalation of radon and its progeny at levels that occur naturally in homes.

46. The Committee found, however, that the contribution of a given technology to the exposures of the global public was not simply a function of how much electricity that technology generated. There were also differences in the collective doses per unit of electricity generated by each technology to take into account. In normal operations, the coal cycle gave a higher collective dose per unit of electricity generated than the nuclear cycle, and a significantly higher dose per unit of electricity produced than the other technologies evaluated, with the exception of geothermal power. Based on the limited information available about radon discharges from geothermal power plants, the collective dose per unit of electricity generated by geothermal power could be significant. However, because the use of geothermal technology is not widespread, its contribution to radiation exposures of the global public is smaller than that from the coal cycle.

47. Previous investigations into electricity generation from nuclear power have examined the contribution to public exposures made by long-lived radionuclides, such as carbon-14, which after being discharged circulate globally and continue to contribute to radiation exposures of the public centuries into the future, albeit at extremely small individual doses. The contribution of the globally circulating radionuclides to the collective dose to the global public depends on the length of time for which the collective dose is integrated. Public exposures due to one year's discharge of these globally circulating radionuclides continue to increase slowly over time. Over long integration times, such as hundreds of years, these radionuclides result in a larger collective dose to the global public from the nuclear fuel cycle than from the coal cycle.

48. The Committee also assessed occupational exposures. The largest collective dose to workers per unit of electricity generated resulted from coal mining, because of exposures to naturally occurring radionuclides. Of all the collective doses evaluated, both to the public and to workers, the exposure of workers from coal mining made the largest contribution, although it has fallen over time because of improving mining conditions. With regard to the construction phase of the electricity-generating technologies, by far the largest collective dose to workers per unit of electricity generated was found in the solar power cycle, followed by the wind power cycle. The reason for this is that these technologies require large amounts of rare earth metals, and the mining of low-grade ore exposes workers to natural radionuclides during mining.

49. The total collective dose per unit of electricity generated in the coal cycle (i.e., the dose to the global public and all exposed workers combined) was larger than that found in the nuclear fuel cycle. This held true even if long-lived globally-circulating radionuclides were integrated over 500 years. When considering the amount of electricity generated in the year 2010 by each technology, the coal cycle resulted in the largest collective dose to the global public and workers combined, followed by the nuclear fuel cycle. Of the remaining technologies, geothermal energy and the combustion of natural gas were the next largest contributors.

50. Great care should be taken when interpreting and using these results. Their only function is to provide an insight into the different magnitudes of radiation exposure resulting from each technology. They are unfit to be used as the only metric to determine whether one energy generation technology is preferable to another. As stated earlier, a number of factors determine why countries may select a certain mix of energy generation technologies. Radiation exposure is only one of them.

### **C. Biological effects of selected internal emitters**

51. “Internal emitters” is the commonly used term for radionuclides deposited in body organs and tissues following their intake, principally by inhalation or ingestion, but also potentially through wounds or intact skin. Depending on the radionuclide concerned and the physicochemical form of the intake, internal emitters vary enormously by type, pattern and duration of their radioactive emissions and energy deposition within and between organs and tissues.

52. It is important to study exposures to internal emitters directly because the radiation from some radionuclides is short-ranged and, to varying degrees, densely ionizing. Moreover, such radionuclides may be distributed unevenly among body tissues. Consequently, the nature of the dose delivered by some internal emitters differs markedly from that delivered by radiation penetrating from external sources such as the atomic bombs detonated in Hiroshima and Nagasaki, Japan. Most of the evidence of risk from radiation comes from studies of human exposure to penetrating radiation, while very few direct data are available on the health effects from internal exposure. Therefore doses to organs from internal emitters have to be estimated using models, and risk factors are derived principally from studies on external penetrating radiation. Under those circumstances it is highly desirable to

validate the underlying assumptions by obtaining real observations of populations exposed internally to radiation from specific radionuclides.

53. In response to initiatives in a number of countries to estimate the appropriate doses from tritium and radioisotopes of uranium and understand the corresponding health effects, the Scientific Committee has reviewed the relevant information on these radionuclides. Two scientific annexes provide the rationale for the Committee's conclusions set out here.

54. Tritium ( $^3\text{H}$ ) is a radioactive isotope of hydrogen that decays solely by low-energy beta-particle emission. It occurs both naturally, mainly as a result of interaction between cosmic-ray particles and the upper atmosphere, and artificially, in the operation of nuclear reactors and other industrial installations, as a substance used in biomedical research and, in the past, as an ingredient used in a variety of consumer products. In the future tritium is expected to be used on a large scale in fusion reactors. In the environment and at the workplace tritium is encountered mainly as tritiated water in liquid or vapour form. An aspect of environmental and food-chain transfer that warrants further investigation is the accumulation of tritium in the organic component of foodstuffs, referred to as organically-bound tritium.

55. Uranium is a naturally occurring element and is ubiquitously distributed in the environment. There are three naturally occurring radioisotopes of uranium:  $^{234}\text{U}$ ,  $^{235}\text{U}$  and  $^{238}\text{U}$ . These are present in rocks and soils and hence in the human diet. They decay mainly by alpha-particle emission and have very long half-lives. Internal exposures of workers to uranium are mainly the result of mining activities and its use as a nuclear fuel. In daily life, people are exposed to uranium originating mainly from drinking water and foodstuffs. Concern has been expressed over exposures of military personnel and members of the public to depleted uranium (isotope mixtures containing a low percentage of  $^{235}\text{U}$ ) used in munitions, for example by the General Assembly in its resolution 69/57 on the effects of the use of armaments and ammunitions containing depleted uranium.

56. Whereas absorbed doses to body organs as a result of exposures to external sources of radiation are calculated using anatomical models of the human body, commonly referred to as phantoms, estimating doses from internal emitters additionally requires biokinetic models that describe the behaviour of radionuclides following their intake into the body, principally by inhalation or ingestion. Such models consider the deposition of inhaled particles and vapour in the respiratory tract and the passage of ingested radionuclides through the alimentary tract. Models also represent the subsequent distribution of radionuclides to body organs and tissues from blood, their retention in those sites of deposition, and their excretion. The reliability of models used to estimate doses from individual elements and their radioisotopes depends on the quality of available experimental and human data.

57. For tritium, models are available in the form of tritiated water, representing its distribution throughout body organs and tissues according to their water content. Less information is available with which to construct adequate models for the behaviour of various forms of organically bound tritium and other tritiated compounds, including amino acids, some of which are involved in the synthesis of DNA and associated proteins. The absorption of uranium depends partly on whether it is inhaled or ingested and varies substantially according to the physical and chemical form of the uranium. Uranium absorbed to blood accumulates mainly in

the skeleton but with some retention also in the kidneys during the rapid urinary excretion of a large fraction.

58. Different types of radiation vary in their effectiveness in causing cancer and other health effects. Two broad categories of radiation are photons and charged particles such as electrons and alpha particles. Some types of charged particles are generally more effective at causing cancer per unit of absorbed dose than penetrating photons. The assessment of such differences relies largely on experimental data about their relative biological effectiveness (RBE), defined as the ratio of the absorbed dose of a reference radiation to the absorbed dose of a test radiation required to produce the same biological effect.

59. There is extensive literature on studies of RBE for tritium beta particle emissions. Values of RBE for a range of biological end points range from about unity to several-fold higher compared to gamma rays and X-rays. However, the ability to draw conclusions for carcinogenesis is limited by the very small number of relevant studies in mammals. Limited information is available that could be used to estimate RBE values for alpha-particle emissions from isotopes of uranium. However, RBE values for alpha particles depend on the particles' energy, range and the dense deposition of energy along short tracks, and the values of RBE will be largely independent of the radionuclide concerned other than when the radionuclide determines the origin within body tissues of the emission. Typical values of RBE reported for alpha particles relative to gamma rays or X-rays are around ten for the end points of liver and lung cancer, with lower values for leukaemia.

60. While the tumorigenic effects of uranium in animals are likely related to radiological toxicity due to alpha-particle emissions, some effects are clearly related to the chemical toxicity of uranium species, particularly in the kidneys. Chemical toxicity is the limiting factor determining currently acceptable levels of uranium in drinking water.

61. A number of epidemiological studies have been conducted of workers and members of the public who may have been exposed to tritium. However, none of these studies have so far been informative in showing an increased frequency of cancer in the exposed populations that could be attributed to radiation exposure from tritium. Epidemiological studies of nuclear workers have shown a weak association between exposures from uranium and rates of lung cancer, but the data are not sufficiently conclusive to demonstrate a causal relationship.

62. The Committee considered studies on the health effects of depleted uranium used in munitions for military applications. No clinically significant pathologies related to exposure from depleted uranium were found in military personnel or members of the public. This is consistent with expectations, given the low levels of measured or assessed exposures.

63. The Committee recognizes that continued research and review is needed to assess the effects of internal exposures. Further work is required to understand the effects of uneven delivery of doses from internal emitters within tissues and cells relative to the uniform delivery of doses from external exposure to penetrating radiation. The complexity of changing exposures and tissue sensitivities during in utero and early postnatal development should also be a focus for further research.

## Appendix I

### Members of national delegations attending the fifty-seventh to sixty-third sessions of the United Nations Scientific Committee on the Effects of Atomic Radiation

Argentina	A. J. González (Representative), A. Canoba, P. Carretto, M. di Giorgio, M. G. Ermacora
Australia	C.-M. Larsson (Representative), C. Baggoley, M. Grzechnik, G. Hirth, P. Johnston, S. B. Solomon, R. Tinker
Belarus	A. Stazharau (Representative), J. Kenigsberg (Representative), A. Nikalayenka, A. Rozhko, V. Ternov, N. Vlasova
Belgium	H. Vanmarcke (Representative), S. Baatout, H. Bijwaard, H. Bosmans, G. Eggermont, H. Engels, F. Jamar, L. Mullenders, H. Slaper, P. Smeesters, A. Wambersie, P. Willems
Brazil	J. G. Hunt (Representative), D. R. Melo (Representative), M. Nogueira Martins (Representative), D. de Souza Santos, L. Holanda Sadler Veiga, M. C. Lourenço, E. Rochedo
Canada	P. Thompson (Representative), N. E. Gentner (Representative), B. Pieterse (Representative), C. Purvis (Representative), D. Boreham, K. Bundy, D. B. Chambers, J. Chen, P. Demers, S. Hamlat, R. Lane, C. Lavoie, E. Waller, D. Whillans
China	Pan Z. (Representative), Chen Y., Dong L., Du Y., Gao H., Li F., Lin X., Liu J., Liu S., Liu Y., Pan S., Qin Q., Song G., Su X., Sun Q., Wang Y., Xuan Y., Yang H., Yang X., Zhang W., Zhou P., Zhu M.
Egypt	W. M. Badawy (Representative), T. S. El-Din Ahmed Ghazey (Representative), M.A.M. Gomaa (Representative), T. Morsi
Finland	S. Salomaa (Representative), A. Auvinen, R. Bly, E. Salminen
France	L. Lebaron-Jacobs (Representative), A. Rannou (Representative), E. Ansoborlo, J.-M. Bordy, M. Bourguignon, I. Clairand, I. Dublineau Naud, A. Flüry-Hérard, J.-R. Jourdain, R. Maximilien, F. Ménétrier, E. Quémeneur, M. Tirmarche
Germany	P. Jacob (Representative), W. Weiss (Representative), S. Baechler, A. Böttger, A. A. Friedl, K. Gehrcke, T. Jung, G. Kirchner, J. Kopp, R. Michel, W.-U. Müller, W. Rühm, H. Zeeb
India	R. A. Badwe (Representative), S. K. Apte (Representative), K. S. Pradeepkumar (Representative), K. B. Sainis (Representative), B. Das, P. C. Kesavan, Y. S. Mayya
Indonesia	E. Hiswara (Representative), Z. Alatas (Representative), S. Widodo (Representative), G. B. Prajogi, G. Witono, B. Zulkarnaen



Japan	Y. Yonekura (Representative), K. Akahane, M. Akashi, S. Akiba, T. Aono, N. Ban, M. Chino, H. Fujita, K. Kodama, M. Kowatari, M. Nakano, O. Niwa, K. Ozasa, S. Saigusa, K. Sakai, G. Suzuki, M. Takahashi, T. Takahashi, Y. Yamada, H. Yamagishi, H. Yasuda
Mexico	J. Aguirre Gómez (Representative)
Pakistan	Z. A. Baig (Representative), M. Ali (Representative), R. Ali
Peru	A. Lachos Dávila (Representative), L. V. Pinillos Ashton (Representative), B. M. García Gutiérrez
Poland	M. Waligórski (Representative), L. Dobrzyński, M. Janiak, M. Kruszewski
Republic of Korea	B. S. Lee (Representative), M. Baek, K.-W. Cho (Representative), K.-H. Do, J.-I. Kim, K. P. Kim, S. H. Kim, D.-K. Keum, J. K. Lee, J. E. Lee, S. H. Na (Representative), S. Y. Nam, S. W. Seo
Russian Federation	A. Akleyev (Representative), M. Kiselev (Representative), R. Alexakhin, T. Azizova, S. Geraskin, V. Ivanov, N. Koshurnikova, A. Koterov, A. Kryshev, I. Kryshev, B. Lobach, S. Mikheenko, O. Pavlovsky, A. Rachkov, S. Romanov, A. Samoylov, A. Sazhin, S. Shinkarev
Slovakia	L. Auxtová (Representative), E. Bédi (Representative), M. Zemanová (Representative), M. Chorváth, A. Ďurecová, V. Jurina, Ž. Kantová, K. Petrová, L. Tomášek, I. Zachariášová
Spain	M. J. Muñoz González (Representative), D. Cancio, M. T. Macías Domínguez, J. C. Mora Cañadas, B. Robles Atienza, E. Vañó Carruana
Sudan	N. A. Ahmed (Representative), I. Salih Mohamed Musa (Representative), E.A.E. Ali (Representative), A. E. Elgaylani (Representative), M.A.H. Eltayeb (Representative), I. I. Suliman
Sweden	I. Lund (Representative), L. Hubbard (Representative), L. Moberg (Representative), A. Almén, E. Forssell-Aronsson, L. Gedda, J. Johansson Barck-Holst, J. Lillhök, A. Wojcik
Ukraine	D. Bazyka (Representative)
United Kingdom of Great Britain and Northern Ireland	S. Bouffler (Representative), J. Cooper (Representative), J. Harrison (Representative), A. Bexon, J. Simmonds, R. Wakeford, W. Zhang
United States of America	R. J. Preston (Representative), F. A. Mettler Jr. (Representative), A. Ansari, L. R. Anspaugh, J. D. Boice Jr., W. Bolch, H. Grogan, N. H. Harley, E. V. Holahan Jr., B. A. Napier, D. Pawel, G. E. Woloschak

## Appendix II

### **Scientific staff and consultants cooperating with the United Nations Scientific Committee on the Effects of Atomic Radiation in the preparation of its scientific report for 2016**

L. Anspaugh

B. Lauritzen

M. Balonov

I. Dublineau

H. Grogan

L. Hubbard

B. Lambert

C. Robinson

E. Rochedo

R. Shore

J. Simmonds

R. Wakeford

### **Secretariat of the United Nations Scientific Committee on the Effects of Atomic Radiation**

M. J. Crick

F. Shannoun

## ANNEX A

# METHODOLOGY FOR ESTIMATING PUBLIC EXPOSURES DUE TO RADIOACTIVE DISCHARGES



## Contents

I. INTRODUCTION .....	23
II. GENERAL CONSIDERATIONS .....	24
A. Dosimetric quantities.....	24
B. Integration times .....	29
C. End points considered .....	30
D. Discharges considered.....	31
III. DESCRIPTION OF THE METHODOLOGY .....	32
A. Assessment of doses from discharges to atmosphere.....	34
B. Assessment of doses from discharges to a freshwater environment.....	48
C. Assessment of doses from discharges to a marine environment .....	64
IV. GLOBALLY DISPERSED RADIONUCLIDES .....	70
A. Tritium .....	70
B. Carbon-14.....	71
C. Iodine-129 .....	72
D. Krypton-85 .....	72
V. LIMITATIONS OF THE MODELS AND DATA USED .....	73
A. Discharges to atmosphere .....	74
B. Discharges to freshwater and marine environments .....	75
C. Global modelling .....	76
D. Comparison of the current and previous methodologies .....	77
VI. APPLICATION OF THE METHODOLOGY .....	78
VII. CONCLUSIONS.....	90
VIII.ACKNOWLEDGEMENTS .....	91
TABLES .....	97
REFERENCES.....	127

Electronic attachments (<http://www.unscear.org/unscear/en/publications/2016.html>)

1. Comparison of the Committee's earlier and current methodologies
2. Summary of the Committee's pre-2010 methodologies and their development
3. Population densities around uranium mines and nuclear power sites
4. Sensitivity studies in support of the methodology development
5. Electronic workbooks that implement the current methodology



## I. INTRODUCTION

1. For many years the Committee has had a methodology for assessing the radiation exposures of the general public from discharges of radionuclides to the environment, where the term discharge refers to authorized releases from normal operations. The methodology does not apply for accidental releases. Every few years, the Committee has updated its estimates of the global radiological impact of the various types of nuclear installation, using this methodology and the latest available information on the level and nature of discharges. The most recent versions of the methodology, which in turn were built on earlier versions, were published in annex A of the UNSCEAR 2000 Report [U6] and annex B of the UNSCEAR 2008 Report [U10]. Although used successfully for many years, the Committee decided at its fifty-sixth session in 2008 to review and, where appropriate, update its methodology [U10] as part of its strategic plan for 2009–2013, with a view to subsequently updating its assessments of the levels of radiation exposure from energy production.

2. The global impact of energy production was one of the Committee’s thematic priorities identified in its strategic plan for 2014–2019 (see [U12]). The Committee decided to specifically assess the global radiological impact of discharges from both nuclear and non-nuclear sources of electrical energy production, and thus to review its methodology so that it could be used to:

- (a) Evaluate the radiation levels worldwide to which people are usually exposed as a consequence of electricity generation;
- (b) Assess the typical variations in exposure worldwide to different sources of radioactive discharges;
- (c) Identify sources of possible concern for public exposure;
- (d) Allow users to derive benchmarks for comparison purposes and to derive relationships for their investigative work;
- (e) Analyse temporal trends in the contributions of different sources to overall public exposure.

3. The Committee recognizes that it is impractical to carry out a full site-specific assessment for each site of electricity generation in the world that discharges radionuclides to the environment. However, it decided that, where possible, its approach should be able to take into account differences among regions of the world. It also decided that the methodology should be robust, transparent and applicable to the different electrical energy sources, and that it should build on the experience gained in applying the previous methodology. One change agreed was that for ease of application to different electrical energy sources and to all parts of the nuclear fuel cycle, the methodology should provide estimates of the doses<sup>1</sup> per unit discharge of key radionuclides to different environments. With information on the discharges from the various facilities, these factors could then be used to estimate doses per unit electrical energy produced (see annex B).

---

<sup>1</sup> Where the word “dose” is used in this annex without qualification, it should be taken to mean effective dose to an individual or collective effective dose to a population, according to context, unless otherwise stated.

4. The methodology is thus designed to assess individual and collective doses from unit discharge of each of the key radionuclides to atmosphere, lakes, rivers and seas. The individuals considered are those living in the area local to the point of discharge with behaviour indicative of most people living in that area; the doses to these characteristic individuals are referred to here as “characteristic individual doses” and are not to be confused with those to the so-called “representative person” (previously termed by the International Commission on Radiological Protection, ICRP, as the “critical group”) used for radiation protection purposes [I13]. The Committee agreed that, where possible, estimates should be available for collective doses as a function of distance from the point of discharge and of the levels of individual dose that make up these collective doses. The Committee also agreed to take account of some differences among geographical regions, notably on population densities. For ease of application and transparency, the methodology has been implemented through a series of Excel<sup>®</sup> workbooks, which should also facilitate any future updates of the Committee’s assessments.

5. The Committee intends to use the methodology to conduct its worldwide assessments of the radiological impact of discharges of radionuclides. The methodology aims to provide best estimates of radiation doses, in contrast to other established methodologies (e.g. [I2]) which aim to ensure that doses are not underestimated and thus adopt cautious parameter values and assumptions. The Committee’s methodology only applies to continuous routine releases to the environment and is not intended to be comprehensive, covering all situations and other uses (such as for estimating the risks of radiation-induced health effects).

6. This scientific annex describes the methodology to assess doses from discharges to atmosphere, freshwater bodies and sea, together with the approach adopted for globally dispersed radionuclides. The limitations of the models and data used are also discussed. An appendix provides detailed information on the implementation of the methodology, including the end points considered, the relevant mathematical equations and model parameters, a specification of the series of Excel<sup>®</sup> workbooks that implement the methodology, information on how the workbooks can be used to assess exposures from different types of discharge, and a description of how progeny of radionuclides were treated and quality assurance conducted. In addition more detailed supporting information and the workbooks themselves are provided in electronic attachments, which can be downloaded only from the UNSCEAR website (<http://www.unscear.org/unscear/en/publications/2016.html>).

## II. GENERAL CONSIDERATIONS

### A. Dosimetric quantities

7. Although for strict scientific purposes other quantities are appropriate, the Committee has for many years used two protection quantities, namely effective dose and collective effective dose for its evaluations of levels and trends of exposures. These have the advantage of simplifying comparison of doses from different types of radiation and different distributions of dose within the body, and of averaging over age and sex; moreover, many regulatory authorities keep records in terms of these quantities. The quantity effective dose is based on another underlying radiation protection quantity, the equivalent dose, which takes into account the inferred differences in biological effectiveness of different types of radiation by applying defined radiation weighting factors to the absorbed dose to an



organ or tissue. Equivalent doses to different organs and tissues are then combined using defined tissue weighting factors, which take into account the inferred differences in detriment from irradiation of the particular organ or tissue, averaged over the sex and age distributions of typical populations. This enables external and internal exposures from a source of radiation to be added to produce an overall effective dose<sup>2</sup> from that source, which can then be compared with effective doses from other sources. In this annex, the definition of effective dose used to express both individual and collective doses is generally that of Publication 60 of the ICRP [I10]. Although ICRP made some modifications to the weighting factors in the definition of effective doses in its 2007 recommendations [I13], it has not yet published a full set of dose coefficients for external and internal exposure and so the Committee has used the previous values, unless otherwise stated.

8. It is important to note that there are differences between the quantities of individual and collective dose, although they are calculated in similar ways. In this methodology and any related studies, the collective (effective) dose is always estimated for a defined population over a specified period of time. The collective dose used here is the product of the mean effective dose to a specified population from a particular source, and the number of people in that population, integrated over a defined period of time. In other words, a collective dose is the dose received by all members of a particular population combined, over a defined period of time. When evaluating collective doses, the population and time period should always be specified and any underlying assumptions—such as the population remaining the same over the time period—should be acknowledged. The Committee has used the quantity, collective dose, for many years to compare the radiation exposures of populations from different sources of ionizing radiation, or following different protection measures. In particular, the quantity provides a convenient basis for comparing the impacts of radioactive discharges from nuclear and other sources of electrical energy, and for incorporation by analysts into measures of economic utility for decision-aiding. However, collective dose should only be used for comparative purposes; it is inappropriate to use it for quantifying exposure in epidemiological studies or for making risk projections. Specifically, the Committee has stated that it does not recommend the aggregation of very low doses over extended time periods to large numbers of individuals to estimate absolute numbers of radiation-induced health effects within a population exposed to incremental doses at levels equivalent to or lower than normal natural background levels [U13].

9. The Committee decided to retain its previous approach where collective dose was estimated for local, regional and global components. The spatial variation in collective dose can be estimated for discharges to atmosphere because (a) dispersion can be expressed as a function of distance from the discharge point and (b) data on the distribution of population density are also available as a function of distance. However, for aquatic discharges, when using a simple generic approach, it is not possible to determine collective doses as a function of distance. Because people over a wide area may all obtain their drinking water and fish from the same water body, there is not a simple relationship between distance from the discharge point and dose. A simplified approach is therefore used based on a discharge to a single water body so that, for aquatic discharges, less spatial resolution in collective doses is possible than for discharges to atmosphere.

10. The Committee considered that the assessment of characteristic individual doses is also useful in addressing the thematic priority in its strategic plan mentioned above. As noted previously, as far as possible, the dose estimates are based on best estimates of parameter values. For example, for discharges to atmosphere, the characteristic individual dose estimated is the dose to someone living

---

<sup>2</sup> For both individual and collective doses, the effective doses estimated here are the sum of the effective doses from external exposure received during the period of interest and the committed effective doses from intakes by inhalation and ingestion during the same period.

5 km from the discharge point who is assumed to obtain a proportion of their food from this location, rather than a more cautious assumption of living 1 km or less from the discharge point. For aquatic discharges, the characteristic individual dose estimated is the dose to someone assumed to be living in the area near to the discharge location and to obtain part of their food—and in the case of discharges to freshwater bodies, their drinking water—from the receiving water body.

11. In this regard, for estimating characteristic individual doses, the Committee considered it to be more realistic to assume that only a proportion of their food consumed was locally produced (locally produced food is that grown by the individual or bought fresh from local markets) rather than an approach often used for regulatory purposes of assuming all their food consumed was 100% locally produced. There is little information on how much locally produced food people consume. In France, a comprehensive investigation was carried out to determine the amount of locally produced food that people ate [B3]. This showed that rural populations in France consumed more locally produced food than urban populations, as would be expected, and that there was a significant variation for different foods. For example, for milk consumption in France as a whole, only 3% was found to be locally produced but in rural areas, the figure was 30%, on average. For leafy vegetable consumption in France as a whole, just over 25% was found to be locally produced but in rural areas the figure was 70%. For cereal consumption in France, the percentage locally produced was very low, at 0.1% both for the country as a whole and for rural areas. While recognizing that there are likely to be wide variations in practice across the world, the Committee agreed that a simple assumption of 25% of the food consumed being locally produced was reasonable for its generic methodology and that this value be used for both terrestrial and aquatic foods. This value is consistent with the value used in the Committee's recent assessment of doses in Japan following the nuclear accident at the Fukushima-Daiichi nuclear power station [U12].

12. The methodology employs published dose coefficients to estimate doses from external and internal exposure. The dose coefficients used for internal exposure are those for adult members of the public and are the committed effective doses to 70 years of age per unit intake of radionuclide given by ICRP [I14]. The dose coefficients for external exposure from radionuclides in the air or deposited on the ground following discharges to air or water bodies were selected from literature sources relevant to the situation being considered. The main dose coefficients used for internal and external exposure are summarized in table 1 both for radionuclides that are discharged and for their key progeny, where appropriate (see also the appendix). It should be noted that for dose coefficients for internal exposure the contribution of short-lived progeny is included in the dose coefficient assigned to the parent. However, for the dose coefficients for external exposure the dose coefficients are for the parent alone and any contribution from short-lived progeny has to be added separately using the values given in table 1(b). Except for isotopes of argon (e.g.  $^{41}\text{Ar}$ ), krypton (e.g.  $^{85}\text{Kr}$ ), xenon (e.g.  $^{133}\text{Xe}$ ,  $^{135}\text{Xe}$  and  $^{138}\text{Xe}$ ) and radon (e.g.  $^{222}\text{Rn}$ ), which are all gases, the discharges are assumed to be particulate with a default size of 1  $\mu\text{m}$  AMAD. The dose coefficients for tritium in the form of tritiated water (HTO) and of organically bound tritium (OBT) are provided for use with the "specific activity" model for tritium in the environment described in chapter III. The chemical form assumed for each element is generally the default type for public exposure given in ICRP Publication 72 [I12].

Table 1. Radionuclide-specific dose coefficients for internal exposure from inhalation and ingestion and for external exposure from the plume and deposition

Values are given to one decimal place only as this is considered sufficient for this purpose

## (a) Radionuclides discharged

Radio-nuclide	Progeny <sup>d</sup>	Lung absorption type <sup>b</sup> [112]	Committed effective dose coefficients for adults to age 70 years for internal exposure <sup>c</sup>		Effective dose coefficients for external exposure <sup>d</sup>	
			Inhalation $D_{inh}$ (Sv/Bq) [114]	Ingestion $D_{ing}$ (Sv/Bq) [114]	Plume $D_{ex,cloud}$ (Sv/(Bq s/m <sup>3</sup> )) [E2, P2]	Deposition $D_{ex,deposit}$ (Sv/(Bq/m <sup>2</sup> )) <sup>e</sup> [P2]
<sup>3</sup> H	—	M	$4.5 \times 10^{-11}$	0	0	0
<sup>14</sup> C	—	M	$2.0 \times 10^{-9}$	$5.8 \times 10^{-10}$	$2.6 \times 10^{-18}$	0
<sup>35</sup> S <sup>f</sup>	—	M	$1.4 \times 10^{-9}$	$7.7 \times 10^{-10}$	$3.1 \times 10^{-18}$	0
<sup>41</sup> Ar <sup>f</sup>	—	n/a	0	0	$6.2 \times 10^{-14}$	0
<sup>54</sup> Mn	—	M	$1.5 \times 10^{-9}$	$7.1 \times 10^{-10}$	$3.9 \times 10^{-14}$	$5.2 \times 10^{-14}$
<sup>58</sup> Co	—	M	$1.6 \times 10^{-9}$	$7.4 \times 10^{-10}$	$4.5 \times 10^{-14}$	$5.0 \times 10^{-9}$
<sup>60</sup> Co	—	M	$1.0 \times 10^{-8}$	$3.4 \times 10^{-9}$	$1.2 \times 10^{-13}$	$2.0 \times 10^{-7}$
<sup>65</sup> Zn	—	M	$1.6 \times 10^{-9}$	$3.9 \times 10^{-9}$	$2.8 \times 10^{-14}$	$9.0 \times 10^{-9}$
<sup>85</sup> Kr <sup>f</sup>	—	n/a	0	0	$9.9 \times 10^{-17}$	0
<sup>90</sup> Sr <sup>c</sup>	<sup>90</sup> Y	M	$3.6 \times 10^{-8}$	$2.8 \times 10^{-8}$	$9.8 \times 10^{-17}$	0
<sup>106</sup> Ru <sup>c</sup>	<sup>106</sup> Rh	M	$2.8 \times 10^{-8}$	$7.0 \times 10^{-9}$	0	0
<sup>129</sup> I	—	F	$3.6 \times 10^{-8}$	$1.1 \times 10^{-7}$	$2.8 \times 10^{-16}$	$3.1 \times 10^{-9}$
<sup>131</sup> I <sup>d</sup>	—	F	$7.4 \times 10^{-9}$	$2.2 \times 10^{-8}$	$1.7 \times 10^{-14}$	$2.4 \times 10^{-10}$
<sup>133</sup> Xe <sup>f</sup>	—	n/a	0	0	$1.2 \times 10^{-15}$	0
<sup>135</sup> Xe <sup>f</sup>	<sup>135</sup> Cs	n/a	0	0	$1.0 \times 10^{-14}$	0
<sup>138</sup> Xe <sup>f</sup>	<sup>138</sup> Cs	n/a	0	0	$5.4 \times 10^{-14}$	0
<sup>134</sup> Cs	—	F	$6.6 \times 10^{-9}$	$1.9 \times 10^{-8}$	$7.1 \times 10^{-14}$	$6.2 \times 10^{-8}$
<sup>137</sup> Cs <sup>c</sup>	<sup>137m</sup> Ba	F	$4.6 \times 10^{-9}$	$1.3 \times 10^{-8}$	$9.3 \times 10^{-17}$	$4.6 \times 10^{-13}$
<sup>210</sup> Pb	—	M	$1.1 \times 10^{-6}$	$6.9 \times 10^{-7}$	$4.5 \times 10^{-17}$	$2.5 \times 10^{-10}$
<sup>210</sup> Po	—	M	$3.3 \times 10^{-6}$	$1.2 \times 10^{-6}$	$3.9 \times 10^{-19}$	$1.2 \times 10^{-13}$
<sup>222</sup> Rn <sup>f,g</sup>	<sup>218</sup> Po, <sup>214</sup> Pb, <sup>214</sup> Bi, <sup>214</sup> Po	n/a	$4.8 \times 10^{-9}$	n/a	n/a	n/a
<sup>226</sup> Ra	—	M	$3.5 \times 10^{-6}$	$2.8 \times 10^{-7}$	$2.8 \times 10^{-16}$	$3.8 \times 10^{-9}$
<sup>230</sup> Th	—	S	$1.4 \times 10^{-5}$	$2.1 \times 10^{-7}$	$1.5 \times 10^{-17}$	0
<sup>232</sup> Th	<sup>228</sup> Ra, <sup>228</sup> Ac, <sup>228</sup> Th, <sup>212</sup> Pb	S	$2.5 \times 10^{-5}$	$2.3 \times 10^{-7}$	$7.2 \times 10^{-18}$	$8.7 \times 10^{-11}$
<sup>234</sup> U	—	M	$3.5 \times 10^{-6}$	$4.9 \times 10^{-8}$	$6.1 \times 10^{-18}$	$5.5 \times 10^{-11}$
<sup>238</sup> U	<sup>234</sup> Th, <sup>234m</sup> Pa	M	$2.9 \times 10^{-6}$	$4.5 \times 10^{-8}$	$2.5 \times 10^{-18}$	$1.9 \times 10^{-11}$
<sup>239</sup> Pu	—	M	$5.0 \times 10^{-5}$	$2.5 \times 10^{-7}$	$3.5 \times 10^{-18}$	$3.5 \times 10^{-11}$
<sup>240</sup> Pu	—	M	$5.0 \times 10^{-5}$	$2.5 \times 10^{-7}$	$3.4 \times 10^{-18}$	$1.5 \times 10^{-11}$
<sup>241</sup> Am	—	M	$4.2 \times 10^{-5}$	$2.0 \times 10^{-7}$	$6.7 \times 10^{-16}$	$7.9 \times 10^{-9}$

## (b) Radionuclides considered to have different chemical forms in the environment or as progeny of others

Radio-nuclide	Lung absorption type <sup>b</sup> [I12]	Committed effective dose coefficients for adults to age 70 years for internal exposure <sup>c</sup>		Effective dose coefficients for external exposure <sup>d</sup>	
		Inhalation $D_{inh}$ (Sv/Bq) [I14]	Ingestion $D_{ing}$ (Sv/Bq) [I14]	Plume $D_{ex,cloud}$ (Sv/(Bq s/m <sup>3</sup> )) [E2, P2]	Deposition $D_{ex,deposit}$ (Sv/(Bq/m <sup>2</sup> )) <sup>e</sup> [P2]
HTO	n/a	$1.8 \times 10^{-11}$	$1.8 \times 10^{-11}$	0	0
OBT	n/a	$4.1 \times 10^{-11}$	$4.2 \times 10^{-11}$	0	0
<sup>90</sup> Y	—	—	—	$7.9 \times 10^{-16}$	0
<sup>106</sup> Rh	—	—	—	$9.4 \times 10^{-15}$	$5.5 \times 10^{-15}$
<sup>135</sup> Cs <sup>f</sup>	F	$6.9 \times 10^{-10}$	$2.0 \times 10^{-9}$	$9.5 \times 10^{-18}$	$2.4 \times 10^{-11}$
<sup>138</sup> Cs <sup>f</sup>	F	$2.4 \times 10^{-11}$	$9.2 \times 10^{-11}$	$1.2 \times 10^{-13}$	$3.9 \times 10^{-12}$
<sup>137m</sup> Ba	—	—	—	$2.7 \times 10^{-14}$	$1.7 \times 10^{-7}$
<sup>212</sup> Pb	—	—	—	$5.7 \times 10^{-15}$	$4.7 \times 10^{-12}$
<sup>214</sup> Pb	M	$1.4 \times 10^{-8}$	$1.4 \times 10^{-10}$	$1.1 \times 10^{-14}$	$5.6 \times 10^{-13}$
<sup>210</sup> Bi	—	—	—	$2.6 \times 10^{-16}$	$2.2 \times 10^{-11}$
<sup>214</sup> Bi	—	$1.4 \times 10^{-8}$	$1.1 \times 10^{-10}$	$7.1 \times 10^{-14}$	$2.5 \times 10^{-12}$
<sup>214</sup> Po	n/a	0	0	$3.8 \times 10^{-18}$	$1.9 \times 10^{-23}$
<sup>218</sup> Po	n/a	0	0	$4.2 \times 10^{-19}$	$2.3 \times 10^{-18}$
<sup>228</sup> Ra	M	$2.6 \times 10^{-6}$	$6.9 \times 10^{-7}$	0	0
<sup>228</sup> Ac	F	$2.5 \times 10^{-8}$	$4.3 \times 10^{-10}$	$4.0 \times 10^{-14}$	$1.7 \times 10^{-11}$
<sup>228</sup> Th	S	$4.0 \times 10^{-5}$	$7.2 \times 10^{-8}$	$8.1 \times 10^{-17}$	$6.9 \times 10^{-11}$
<sup>234</sup> Th	S	$7.7 \times 10^{-9}$	$3.4 \times 10^{-9}$	$2.9 \times 10^{-16}$	$1.3 \times 10^{-11}$
<sup>234m</sup> Pa	n/a	0	0	$1.2 \times 10^{-15}$	$1.1 \times 10^{-14}$

<sup>a</sup> The progeny considered in the methodology are listed. For further details see the appendix; The symbol “—” means either that the progeny are not considered or that the progeny are stable isotopes.

<sup>b</sup> This refers to the rate of absorption from the lung. The symbols relate to fast (F), medium (M) or slow (S) absorption.

<sup>c</sup> For these radionuclides with short-lived progeny, the dose coefficients for internal exposure for the parent include the contribution from the progeny and coefficients are not given separately for the progeny.

<sup>d</sup> In all cases the dose coefficients for external exposure are for the parent only and the contribution from progeny has to be considered separately.

<sup>e</sup> Integrated effective dose to 100 years following a continuous deposition rate of 1 Bq/(m<sup>2</sup> s) for one year. The Petoussi-Henss et al. values are not used directly but are modified to allow for changes in external dose with time [G2].

<sup>f</sup> Considered for discharges to atmosphere only.

<sup>g</sup> See section III.A.3 for more information on the treatment of radon inhalation.

## B. Integration times

13. The methodology is applicable to discharges that can be assumed to be continuous and takes into account (a) the build-up of long-lived radionuclides in the environment and (b) the continued exposure to long-lived radionuclides after discharges have ceased. This is done by considering a year's discharge of a radionuclide, its dispersion in the environment and the subsequent exposures of people over many years; the resulting dose rates are then integrated to various times. Using these integrals, it is also possible to consider that the discharges may continue for many years from the same site. This is because the integrated dose to say 100 years from one year's discharge is numerically equal to the dose in the 100th year from a continuous discharge at a constant rate. The Committee agreed that 100 years was generally a reasonable assumption for the length of continuous discharge for estimating characteristic individual doses as it covers the lifetime of individual power plants and also the possibility that additional power plants may be constructed on the same site. Separate considerations apply for the disposal of waste residues (mill tailings) from uranium and coal mining operations as discussed below.

14. Collective dose rates can be integrated to infinity (referred to as the collective dose commitment) to take account of all possible future doses from a discharge. However collective dose rates are generally integrated to shorter times; values ranging from 80 to 10,000 years have been used in the Committee's past reports, see electronic attachments 1 and 2 (collective doses integrated to various times are sometimes referred to as truncated collective doses). For most radionuclides, integrating collective dose rates to 100 years gives a significant proportion of the collective dose commitment [S9]. However, some relatively long-lived, environmentally mobile radionuclides ( $^3\text{H}$ ,  $^{14}\text{C}$ ,  $^{85}\text{Kr}$  and  $^{129}\text{I}$ ) become globally dispersed and can continue to contribute to the integrated collective doses for many years. For both  $^3\text{H}$  and  $^{85}\text{Kr}$  (half-lives 12.6 years and 10.7 years, respectively), the integrated collective dose does not increase beyond 100 years. However, for  $^{14}\text{C}$  (half-life 5,730 years), the integrated collective dose increases by a factor of more than five between 1,000 and 10,000 years; however the additional collective dose is then negligible if the integration is continued to 1,000,000 years. For the very long-lived  $^{129}\text{I}$  (half-life 15.7 million years), the integrated collective dose increases by about a factor of six between 1,000 and 10,000 years and by a factor of over 150 between 10,000 and 1,000,000 years (based on table 70 of [U5]). However, for discharges from nuclear sites, the integrated collective dose from  $^{14}\text{C}$  rather than that from  $^{129}\text{I}$  dominates the total integrated collective dose and so most of the collective dose will be received in the first 10,000 years [S9, U5]. Also, when comparing options explicit consideration of collective doses at long times is often not necessary because the collective doses at these times are all similar and moreover comprise extremely low levels of individual dose [S9, U5].

15. In general, the uncertainties associated with estimating collective doses increase with integration time, for example, because of possible major changes in environmental conditions and population dynamics. The integrated collective dose to 500 years from a continuous discharge over one year has often been used to provide an upper estimate of the highest future annual collective dose rate if the practice, and hence discharge, were to continue at a constant rate for that number of years [L1]. Five hundred years is used because it is assumed to be the maximum duration of the generation of electrical energy by nuclear power. An integration time of 10,000 years was used in the Committee's assessments conducted before the year 2000. Ten thousand years is consistent with the duration of the warm period between glacial periods [L1] and therefore the maximum number of years over which any reasonable assumptions about the nature of the global environment can be made.

16. When comparing the radiological impact of different sources, it is important not to introduce any bias when choosing integration times for collective dose. For example, choosing a short time (e.g. of a few hundred years) for nuclear power generation would mean that a significant portion of the integrated

collective dose is not included. For non-nuclear energy production, notably that using fossil fuels, the major radionuclides discharged are from the  $^{238}\text{U}$  decay chain, particularly  $^{226}\text{Ra}$  and its progeny including  $^{222}\text{Rn}$ . These radionuclides do not become dispersed globally and so once discharged to the environment need to be considered only for relatively short timescales; a few hundred years is sufficient to allow for the ingrowth of the radiologically significant radionuclide,  $^{210}\text{Po}$ .

17. The conventional mining and milling of uranium ore gives rise to various waste residues, which are referred to as mill tailings. These contain enhanced levels of naturally occurring radionuclides and the radon is emitted from the mill tailings for many years following disposal because of the long radioactive half-life of the parent  $^{238}\text{U}$ . In assessing the radiological impact of mill tailings, it is necessary to allow for the number of years over which the emissions will continue. Previously, the Committee estimated collective doses from mill tailings assuming that the emissions of radon continued for 10,000 years [U6]. Since the year 2000, improvements have been made to the treatment of mill tailings and the rehabilitation of areas where mill tailings had been disposed of. As discussed in the companion report on radiation exposures from electricity generation (see annex B), enhanced levels of radon emissions may continue for periods of less than 100 years. The Committee therefore agreed that the best estimate of the period of radon emissions from mill tailings should be reduced to 100 years, but that the effect of considering periods of 500 years and 10,000 years should also be evaluated. The same considerations also apply to the disposal of mine spoil or ash from coal used for electricity generation.

## C. End points considered

18. Taking account of the considerations discussed in sections A and B above, the Committee has developed its methodology to estimate the following characteristic individual doses (expressed as effective doses, in sieverts, Sv) from each radionuclide discharged continuously at a rate of 1 Bq/s:

- (a) For discharges to atmosphere, the characteristic individual dose in the 100th year (as noted above, the dose in the 100th year of continuous discharge is equal to the integrated dose to 100 years from 1 year's discharge) at 5 km from the discharge point (annual individual doses are also calculated at 50, 300, 750 and 1,250 km from the discharge point for use in estimating collective doses);
- (b) For discharges to freshwater bodies, the characteristic individual dose in the 100th year;
- (c) For discharges to a marine environment, the characteristic individual dose in the 100th year.

19. In addition, integrated collective doses (man Sv) from each radionuclide discharged continuously at a rate of 1 Bq/s for a year are calculated as follows:

- (a) For discharges to atmosphere, collective doses are integrated to 100 years (this is equivalent to the collective dose in the 100th year of continuous discharge) in the following distance bands: 0–100 km (local), 100–500 km, 500–1,000 km and 1,000–1,500 km. The results for 100–1,500 km are summed to constitute regional components of collective dose;
- (b) For discharges to freshwater bodies, the collective dose is integrated to 100 years. It should be noted that for freshwater bodies, instantaneous mixing in a single water volume is assumed and, with this assumption, it is not possible to distinguish between local and regional components of collective dose;

(c) For discharges to a marine environment, local and regional components of collective dose are integrated to 100 years;

(d) For globally circulating radionuclides only ( $^3\text{H}$ ,  $^{14}\text{C}$ ,  $^{85}\text{Kr}$  and  $^{129}\text{I}$ ), the global collective dose is integrated to 100, 500 and 10,000 years.

20. The results can be scaled to obtain the characteristic individual and collective doses for specific discharges and sources. In chapter III, results are calculated for discharges from different geographical regions of the world, considering different population distributions (generic, nuclear coastal and nuclear inland). Results are also calculated for a generic discharge location situated in a region of very low population density, which may apply to sites of uranium mines and mill tailings.

## D. Discharges considered

### 1. Electrical energy production

21. One of the aims of the methodology is to allow exposures from discharges of radionuclides to atmosphere and water bodies to be assessed for a range of facilities associated with electricity generation, covering both nuclear and non-nuclear power production. The methodology could also be broadly used to assess routine discharges from other sources, but—as noted earlier—it is not intended for site-specific or regulatory purposes. The assessment of exposures due to electricity generation requires adequate and representative discharge data from the various facilities for input into the models that implement the methodology. For example, discharges from the nuclear facilities involved in power production and the fuel cycle listed in table 2 could be considered.

Table 2. Types of nuclear facility for which the methodology may be relevant

<i>Life-cycle stage</i>	<i>Facility types</i>
Front end	Uranium mine with mill Enrichment and fabrication
Nuclear reactor operation	Nuclear power reactors (e.g. pressurized water reactors, boiling water reactors, fast breeder reactors, gas cooled reactors, heavy water cooled reactors, and light-water-cooled, graphite-moderated reactors) Research reactors
Back end	Reprocessing Decommissioning Waste management

22. There are also a number of non-nuclear means of electrical energy production that may have associated discharges of naturally occurring radionuclides because of the materials used in construction or at some point in their production cycle. The Committee decided that these should also be covered by the methodology and they are considered in annex B. These could include the use of: (a) fossil fuels (coal, gas and oil); (b) geothermal sources; and (c) solar power, wind and biomass.

## 2. Radionuclides discharged

23. The radionuclides covered by the methodology are listed in table 1 and are considered by the Committee to give rise to most of the doses from radioactive discharges from different energy sources. This list of radionuclides includes those that have been demonstrated to give rise to the highest integrated collective doses in previous assessments [C3, U6]. Naturally occurring radionuclides are also covered by the methodology in order to assess the radiological impact of discharges from mining and milling of primary materials, fuel production, and non-nuclear forms of electrical energy production [N4].

24. Although the methodology is designed to use data on discharges of individual radionuclides, in many cases discharge data are provided only for groups of radionuclides as a whole. For example, discharges may be given for “total alpha” and then this value will need to be apportioned among the relevant radionuclides included in the methodology (e.g.  $^{239,240}\text{Pu}$ ,  $^{241}\text{Am}$ ). For discharges specified as total beta/gamma or particulate there may be many radionuclides that could be discharged, with the most important for nuclear power plants generally being  $^{60}\text{Co}$ ,  $^{90}\text{Sr}$ ,  $^{134}\text{Cs}$  and  $^{137}\text{Cs}$  but with significant contributions from others such as  $^{54}\text{Mn}$  or for United Kingdom gas cooled reactors only  $^{35}\text{S}$ . In using the methodology, it will be necessary to specify a fraction of the discharge for each relevant radionuclide and also which representative radionuclides to consider as defaults for the sum of discharges from any radionuclides not included in table 1.

25. The methodology is designed to allow different assumptions to be made about the state of equilibrium between components of the decay chains of the naturally occurring radionuclides. Account is taken of the time necessary for ingrowth to occur and differences between the importance of ingrowth of progeny for different types of discharge and for different exposure pathways. Where appropriate, the contribution of progeny is taken into account according to the following assumptions:

- (a) Where the progeny are short-lived compared to the parent, their contribution is not considered explicitly but is generally included with the parent, for example, contributions from  $^{90}\text{Y}$  and  $^{137\text{m}}\text{Ba}$  are included in the dose coefficients for intakes by inhalation and ingestion for  $^{90}\text{Sr}$  and  $^{137}\text{Cs}$ , respectively;
- (b) Where the progeny are long-lived compared to the parent, their contribution is not considered further if, over a period of 100 years, there is unlikely to be sufficient ingrowth of the progeny. Examples where this is the case are  $^{239}\text{Pu}/^{235}\text{U}$ ,  $^{240}\text{Pu}/^{236}\text{U}$ , and  $^{241}\text{Am}/^{237}\text{Np}$ ;
- (c) The key radionuclides in the decay chains of the naturally occurring radionuclides are considered separately and other progeny are only considered if they make a significant contribution to exposures or if it is reasonable to assume that they would be discharged in secular equilibrium with the parent.

Further information for specific radionuclides and exposure pathways and details of how this is applied in practice are given in the appendix.

## III. DESCRIPTION OF THE METHODOLOGY

26. When radionuclides are discharged to the environment there are various ways in which people can be exposed to radiation. Figure I illustrates the more important exposure pathways.



Figure I. Exposure pathways following discharge of radioactive material to the environment

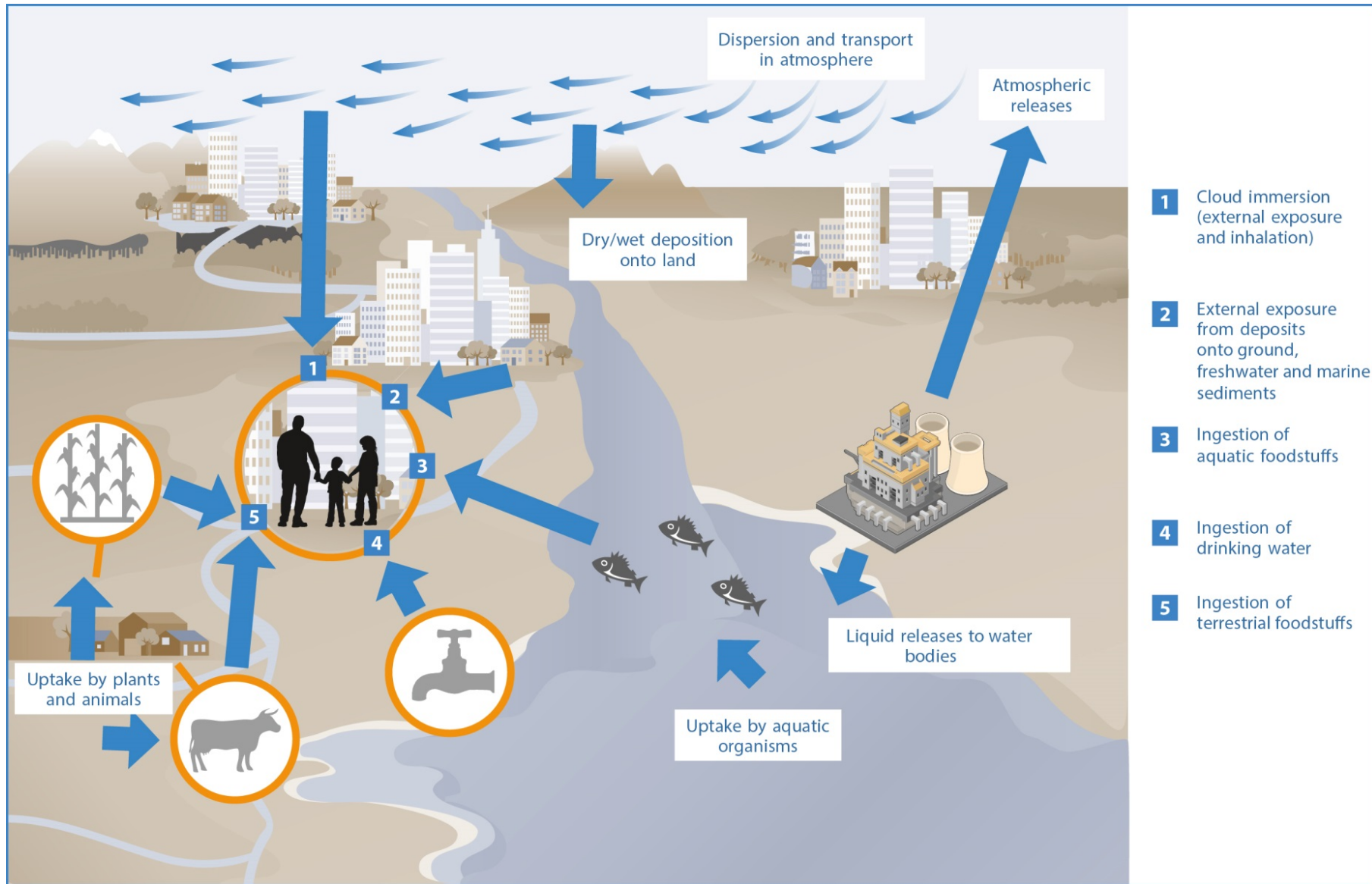

## A. Assessment of doses from discharges to atmosphere

27. This section describes the methodology for estimating characteristic individual and local and regional components of collective dose to the public from a discharge of radionuclides to atmosphere. The appendix gives full details of all of the equations used. The exposure pathways included in the methodology for discharges to atmosphere are:

- (a) Internal exposure from inhalation of radionuclides in the plume;
- (b) External exposure (beta and gamma emitters) from radionuclides in the plume;
- (c) External exposure from deposited radionuclides;
- (d) Internal exposure from ingestion of radionuclides incorporated in food.

28. Other exposure pathways such as internal exposure from inhalation of resuspended radionuclides deposited on the ground and from inadvertent ingestion of soil are also possible. However a review of the literature indicated that the doses from these exposure pathways are negligible compared with those from the exposure pathways listed above for continuous discharges of radionuclides to atmosphere [J5].

29. Characteristic individual doses are calculated for a member of the public assumed to be living at a distance of 5 km from the point of discharge. Local and regional components of collective dose from discharges to atmosphere are derived directly by multiplying individual doses calculated at the midpoints of distance bands or annuli (of 0–100, 100–500, 500–1,000 and 1,000–1,500 km) around the point of discharge by data specific to each geographical region on the number of people within each annulus. Region-specific or generic values are used for parameters in the dose calculation as discussed in the following sections.

### 1. Population distribution

30. The Committee's previous approach was based on simplified assumptions regarding population density around nuclear sites representative of the situation in the 1980s. Given the importance of population information in determining the overall magnitude of collective doses, and that there have been significant changes in population patterns throughout the world, the Committee decided to update the information on population density. For comparison purposes and to examine the effect of different population densities, four different sets of population data are considered in the methodology. As a default case for comparison purposes, the calculation of collective dose from discharges to atmosphere is based on information on population densities for 2010 weighted by the population in each geographical region [F1]. The population distribution used for the default case is given in table 3 where the same population density is used for each annulus (the population is the assumed density multiplied by the area of the annulus). In addition to values by region, a world-average population distribution has been obtained as an average of the values for each region weighted by the populations in each region. The regions considered in the methodology are those used by the United Nations Environment Programme (UNEP), illustrated in figure II below.

Table 3. Default population distributions for different geographical regions

UNEP region	Population density, weighted <sup>a</sup> (km <sup>-2</sup> )	Population within each annulus			
		0–100 km	100–500 km	500–1,000 km	1,000–1,500 km
Africa	$7.9 \times 10^1$	$2.5 \times 10^6$	$5.9 \times 10^7$	$1.9 \times 10^8$	$3.1 \times 10^8$
Asia and Pacific	$2.8 \times 10^2$	$8.8 \times 10^6$	$2.1 \times 10^8$	$6.6 \times 10^8$	$1.1 \times 10^9$
Europe	$1.3 \times 10^2$	$4.0 \times 10^6$	$9.7 \times 10^7$	$3.0 \times 10^8$	$5.0 \times 10^8$
Latin America and Caribbean	$1.4 \times 10^2$	$4.3 \times 10^6$	$1.0 \times 10^8$	$3.2 \times 10^8$	$5.3 \times 10^8$
North America	$3.2 \times 10^1$	$1.0 \times 10^6$	$2.4 \times 10^7$	$7.6 \times 10^7$	$1.3 \times 10^8$
West Asia	$1.0 \times 10^2$	$3.2 \times 10^6$	$7.7 \times 10^7$	$2.4 \times 10^8$	$4.0 \times 10^8$
World average <sup>b</sup>	$1.6 \times 10^2$	$5.0 \times 10^6$	$1.2 \times 10^8$	$3.8 \times 10^8$	$6.3 \times 10^8$

<sup>a</sup>The population densities are taken from FAO [F1] and are values for each region weighted as described in this reference.

<sup>b</sup>The world-average value is the average of the values for each region weighted by the population in each region.

Figure II. The geographical regions used in the methodology (taken from UNEP [U3])

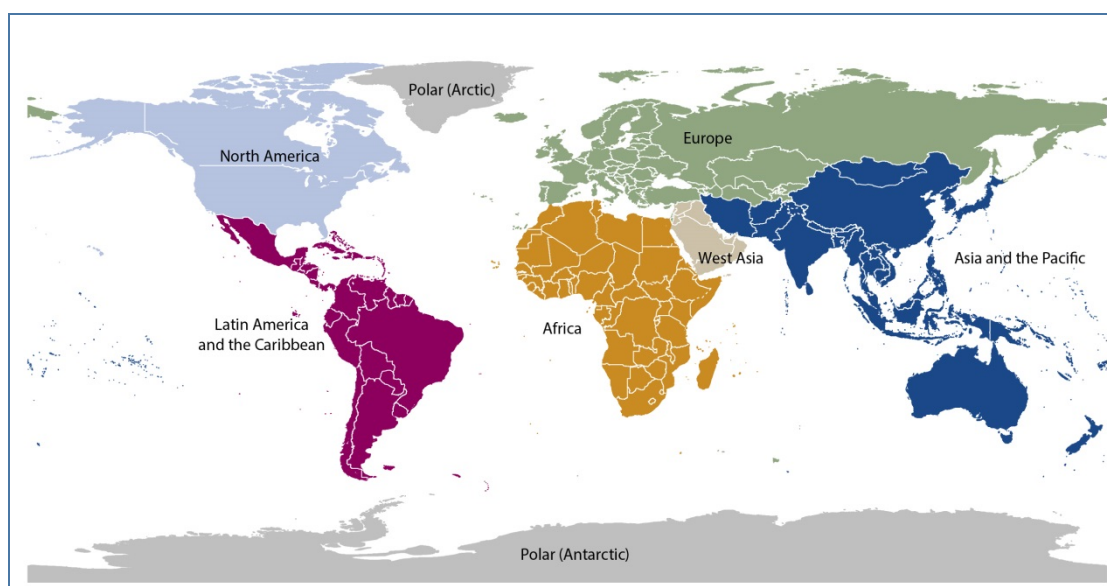

31. For nuclear power stations, a more specific analysis of population data is possible. In collaboration with the Metadata and Socio-Economics Unit of UNEP/DEWA/GRID-Geneva,<sup>3</sup> a geographic information system has been used to express the number of people living within specified distance bands around each station. Details of the approach and data used are given in electronic attachment 3; in essence, the numbers of people living within different distances (100, 500, 1,000 and 1,500 km) around the site of each operating nuclear power station have been analysed. These data have been used to derive simplified averages by UNEP region for the population in each annulus. The averages have been estimated separately for inland sites and for sites located on the coast, where the population distribution is likely to be affected by the presence of a large body of water (see table 4). Again a world-average value has also been calculated using all the available data. Because there were, at the time of analysis, no significant operating nuclear power stations in West Asia and only a coastal

<sup>3</sup> United Nations Environment Programme (UNEP) Division of Early Warning and Assessment (DEWA) Global Resource Information Database network (GRID) <http://www.grid.unep.ch/>.

site for Africa, no population densities are given for these in table 4. The results for the default population distribution in table 3 could be used to consider nuclear sites in these regions if needed.

Table 4. Population distribution around operating nuclear power stations as a function of UNEP region and location

Based on information provided by UNEP for the year 2008

UNEP region <sup>a</sup>	Population within each annulus <sup>b</sup>			
	0–100 km	100–500 km	500–1,000 km	1,000–1,500 km
COASTAL				
Africa	$3.9 \times 10^6$	$1.1 \times 10^6$	$8.7 \times 10^6$	$3.4 \times 10^7$
Asia and Pacific	$8.3 \times 10^6$	$8.8 \times 10^7$	$2.0 \times 10^8$	$3.5 \times 10^8$
Europe	$3.3 \times 10^6$	$6.4 \times 10^7$	$1.3 \times 10^8$	$1.5 \times 10^8$
Latin America and Caribbean	$3.6 \times 10^6$	$6.2 \times 10^7$	$4.8 \times 10^7$	$4.3 \times 10^7$
North America	$4.7 \times 10^6$	$4.0 \times 10^7$	$7.0 \times 10^7$	$6.7 \times 10^7$
West Asia	n/a	n/a	n/a	n/a
World average <sup>c</sup>	$5.6 \times 10^6$	$6.6 \times 10^7$	$1.4 \times 10^8$	$2.0 \times 10^8$
INLAND				
Africa	n/a	n/a	n/a	n/a
Asia and Pacific	$1.9 \times 10^7$	$2.0 \times 10^8$	$4.6 \times 10^8$	$5.0 \times 10^8$
Europe	$4.6 \times 10^6$	$8.9 \times 10^7$	$1.8 \times 10^8$	$1.8 \times 10^8$
Latin America and Caribbean	$4.6 \times 10^6$	$1.5 \times 10^7$	$3.7 \times 10^7$	$3.4 \times 10^7$
North America	$3.0 \times 10^6$	$3.9 \times 10^7$	$7.7 \times 10^7$	$8.5 \times 10^7$
West Asia	n/a	n/a	n/a	n/a
World average <sup>c</sup>	$4.6 \times 10^6$	$7.2 \times 10^7$	$1.5 \times 10^8$	$1.5 \times 10^8$

<sup>a</sup> Note that at the time of analysis there were no significant operating nuclear power stations in West Asia or inland in Africa (see figure II for definition of UNEP regions) and hence population data are not presented for these regions.

<sup>b</sup> Data are presented to one decimal place, which is considered sufficient for this purpose.

<sup>c</sup> The world-average is the average of the population in each annulus for all nuclear sites for which data are available.

32. The other case considered in the methodology is for uranium mines and mill tailings sites. Most of these facilities are situated in areas of very low population densities, as illustrated in electronic attachment 3. Therefore, the methodology also considers a population distribution with a density of  $5 \text{ km}^{-2}$  to gain insight into the effect on collective doses. Using this low population density out to 1,500 km results in estimated collective doses from atmospheric discharges that are about two orders of magnitude lower than those estimated using the population distributions in tables 3 and 4. The low value for population density should therefore only be used where appropriate and where it can be assumed to apply over the integration period for the collective dose.

33. There are two main approaches to assessing collective doses from ingestion of terrestrial foods. The first uses information on the distribution of agricultural production to obtain an overall collective dose from the production but with no indication of the individual doses that make up the collective dose. The second approach, which the Committee adopted here, assumes that people obtain their food

from the area where they live. This enables both individual and collective doses to be estimated. However, as discussed earlier, in many parts of the world it is not realistic to assume that people derive all their food from local produce. This is particularly so within a small area that has a high population density, and therefore low agricultural production. The Committee therefore decided that collective doses from ingestion (where it is assumed that 100% of the food is obtained from the area considered) should only be calculated for distances of at least 100 km. For the characteristic individual dose, based on an individual living at a distance of 5 km from the site, 25% of their food is assumed to be locally produced as discussed earlier (paragraph 11).

## 2. Dispersion in the atmosphere

34. In previous assessments, the Committee adopted a simple generic atmospheric dispersion model. It considered the uncertainties associated with this approach in some detail in its 2000 Report [U6]. Given the generic nature of its assessment objectives, the Committee concluded that the long-term sector-averaged Gaussian model was likely to provide an appropriate level of accuracy. Crawford et al. [C5] acknowledge that simple Gaussian models continue to be used because they produce results that often agree fairly well with measured data and because their results are relatively easy to obtain. The Committee has decided to retain this approach.

35. The variation in activity concentration in air,  $C_a(x)$ , with downwind distance beyond 1 km is approximately given by the following equation:

$$C_a(x) = D_1 \cdot Q \cdot x^{-n} \quad (1)$$

where  $D_1$  is the annual average dilution factor at 1 km ( $\text{s/m}^3$ ),  $Q$  is the discharge rate ( $\text{Bq/s}$ ),  $x$  is the downwind distance (km) and  $n$  is an empirically-determined index. The Committee agreed to retain the parameter values used in the UNSCEAR 2000 Report, in which a value of  $5.3 \times 10^{-7} \text{ s/m}^3$  was found to be the best approximation for  $D_1$  with a value for  $n$  of 1.42 for all radionuclides except noble gases, tritium and carbon-14 [U6]. The dilution factor,  $D_1$ , was found to be relatively insensitive to changes in the values of parameters, except for wind speed and release height. The value of  $n$  was, however, found to be dependent upon deposition velocity and inversion height. For noble gases, which do not deposit, a value of  $n$  equal to 1.2 is retained. This value is also retained for tritium because, although tritium rapidly exchanges with water in the soil and vegetation, it is quickly re-emitted to the atmosphere. Carbon-14 also exchanges with carbon in soil and vegetation and partially returns to atmosphere through plant and soil respiration. A value for  $n$  of 1.4 is therefore used for this radionuclide.

36. As part of the development of the current methodology, the activity concentrations estimated using this simple relationship were compared with the results obtained using a more complex Gaussian model, for a uniform wind rose (for which activity concentrations were averaged over 12 sectors) that allowed for depletion of the plume but not radioactive decay. The results were found to be very similar (less than a factor of two difference).

37. A reduction factor is now included in the methodology to allow for the radioactive decay of short-lived radionuclides, notably radon, during dispersion over distances of hundreds of kilometres. This factor is based on a mean wind speed,  $u_a$ , of 2 m/s [I2].

38. The deposition rate of radionuclides at a specified distance (in  $\text{Bq}/(\text{m}^2 \text{ s})$ ) is determined by the application of a simple “effective deposition velocity” that allows for both wet and dry deposition on vegetation, soil and other surfaces. An annual-average deposition rate of 0.002 m/s [U6] is used for all

radionuclides, with the exception of the noble gases, tritium and  $^{14}\text{C}$  for which a value of zero is applied. As noted above, tritium and  $^{14}\text{C}$  exchange with the soil and vegetation; however, this is modelled using a specific activity approach (as discussed below). Because these radionuclides are returned to atmosphere, the deposition rate is not used and the effective deposition velocity is taken to be zero, even for  $^{14}\text{C}$  which is partly retained on the ground. This is consistent with the use of the generic approach to the modelling of dispersion applied in the UNSCEAR 2000 Report [U6] and, with the application of a value of  $n$  of 1.42, 1.4 or 1.2 in equation 1. The use of these parameters ensures that there is a balance between the activity discharged and the activity deposited within a distance of around 2,000 km, thereby ensuring that the relevant exposures are included in the estimation of collective dose.

39. The calculated activity concentrations in air at ground level depend to some extent on the height from which the discharge takes place and whether the discharge is from a point source or a wide area. The heights of stacks from which discharges take place (i.e. point sources) vary considerably. The discharges from uranium mine and mill tailings, on the other hand, take place at ground level over a wide area. Electronic attachment 4 discusses the variation in estimated activity concentrations in air with stack height and the differences for point and area sources. The differences in the concentration profiles with stack height lessen with distance from the stack. For the case illustrated in electronic attachment 4, where a uniform wind rose is assumed together with Pasquill Category D conditions for 65% of the time and all other categories for the rest of the time, the estimated concentration in air for a ground-level discharge is about a factor of three higher than that from a 100 m stack at a distance of 5 km, and less than a factor of two higher than from a 30 m stack. Larger and smaller differences would be seen for the individual Pasquill categories but this comparison applies to the annual average that is needed for assessing routine continuous discharges. At a downwind distance of 100 km, the difference in concentrations for a ground-level discharge and one from a 100 m stack is about a factor of two. For point and area sources, the differences in estimated activity concentrations at these distances are small. The ratio of the time-integrated activity concentrations in air for an area source to that for a point source is 0.9 at 5 km and is 1 beyond 10 to 20 km (see electronic attachment 4). Given these findings, the Committee agreed that, for its generic methodology, it was reasonable to adopt a single stack height of 30 m and to consider all discharges to atmosphere as point sources.

### 3. Behaviour of radionuclides in a terrestrial environment

40. Radionuclides discharged to atmosphere may be transferred to plants by a number of processes, primarily direct deposition onto the surface of plants and uptake by their roots from material deposited on the soil. The most important processes for the transfer of radionuclides through the terrestrial environment are illustrated in figure III.

Figure III. The important processes for transfer of radionuclides through the terrestrial environment

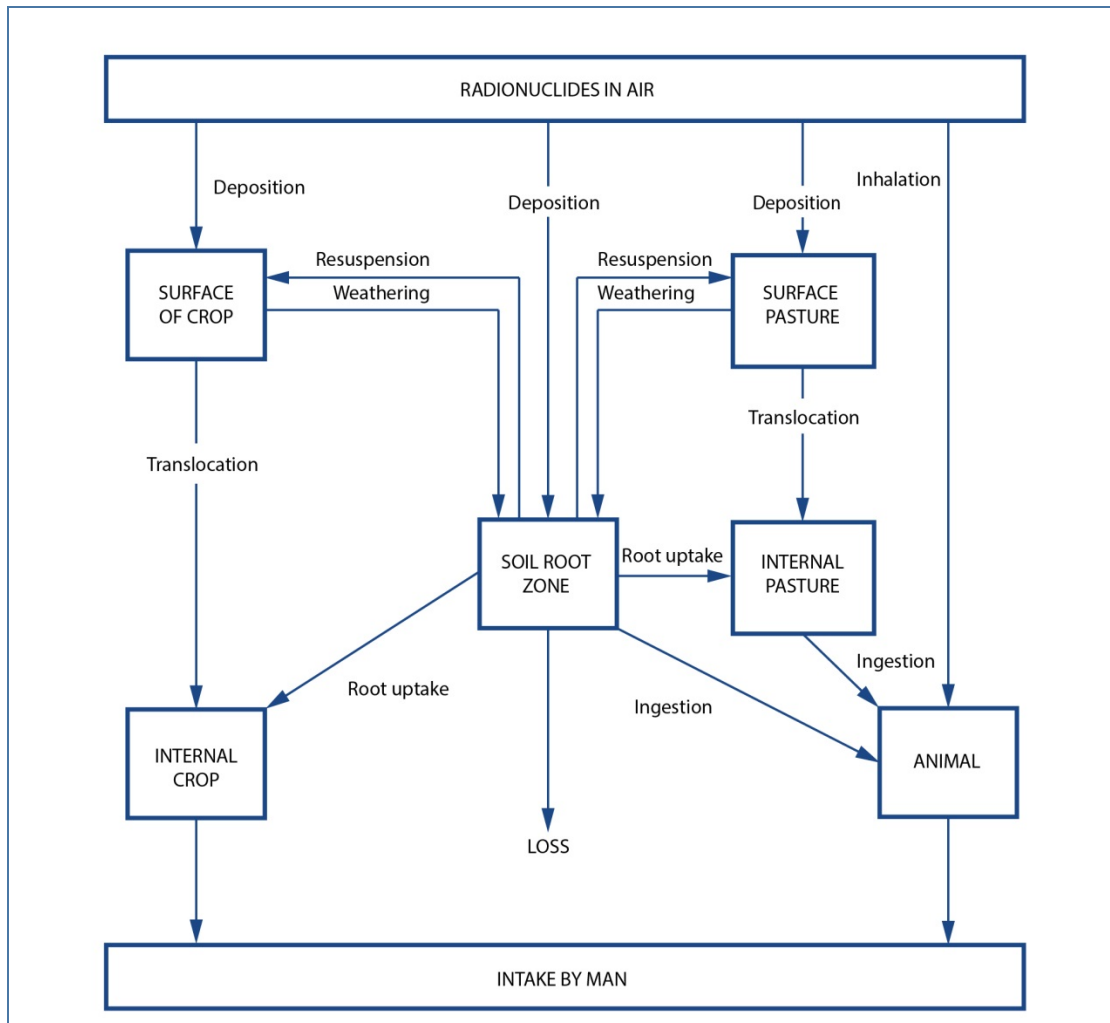

41. There have been significant developments in the modelling of the transfer of radionuclides through the terrestrial environment in recent years, partly as a result of studies following the Chernobyl accident, see for example [C1]. The standard compilations of the concentration factors, linking different parts of the environment, e.g. soil and plants, and other relevant parameters have been reviewed and updated as part of international coordinated research activities [C1, I5].

42. For the purposes of this methodology, the Committee used the dynamic food-chain model FARMLAND [B6], as implemented in PC-CREAM [S8], to derive integrated activity concentrations in food (fresh weight) per unit deposition rate; these are the activity concentrations integrated to 100 years for continuous deposition at a rate of 1 Bq/(m<sup>2</sup> s) for one year. These estimated concentrations take account of the various environmental transfer, migration and loss processes illustrated in figure III and radioactive decay. Values of radionuclide transfer parameters for terrestrial environments were selected from international compilations of data [I1, I5], supplemented by additional data [S8]. Expert judgement was used to select values appropriate for the Committee's purposes which are not overly cautious. The values selected are intended to be appropriate for a range of environments and climates. The FARMLAND model uses a standard approach to estimate the transfer of radionuclides through terrestrial food chains and has been found to be in good agreement with measured data [S8]. In a comparison exercise carried out as part of the IAEA EMRAS II (Environmental Modelling for

Radiation Safety) programme [I6], the results obtained from FARMLAND were found to be in good agreement with those results from other models. The derived activity concentrations applied in the Committee's methodology are summarized in table 5 and full details of the model and parameter values can be found in Brown and Simmonds [B6] and Smith and Simmonds [S8].

Table 5. Activity concentrations in foodstuffs integrated to 100 years for continuous deposition at a rate of 1 Bq/(m<sup>2</sup> s) for one year [S8]

Radionuclide	Integrated activity concentration in food (fresh weight) (Bq/kg per Bq/(m <sup>2</sup> s))			
	Cereals ( <i>C<sub>cereal,unit</sub></i> )	Vegetables & fruits ( <i>C<sub>veg,unit</sub></i> )	Milk & dairy products ( <i>C<sub>milk,unit</sub></i> )	Meat & offal ( <i>C<sub>meat,unit</sub></i> )
<sup>35</sup> S	3.7 × 10 <sup>5</sup>	1.2 × 10 <sup>5</sup>	1.4 × 10 <sup>6</sup>	6.0 × 10 <sup>6</sup>
<sup>54</sup> Mn	8.6 × 10 <sup>4</sup>	1.3 × 10 <sup>5</sup>	9.0 × 10 <sup>4</sup>	1.9 × 10 <sup>5</sup>
<sup>58</sup> Co	5.3 × 10 <sup>4</sup>	9.3 × 10 <sup>4</sup>	3.9 × 10 <sup>5</sup>	7.4 × 10 <sup>5</sup>
<sup>60</sup> Co	1.1 × 10 <sup>5</sup>	1.5 × 10 <sup>5</sup>	2.3 × 10 <sup>6</sup>	1.3 × 10 <sup>7</sup>
<sup>65</sup> Zn	1.8 × 10 <sup>5</sup>	2.2 × 10 <sup>5</sup>	7.0 × 10 <sup>5</sup>	5.8 × 10 <sup>6</sup>
<sup>90</sup> Sr	7.1 × 10 <sup>5</sup>	7.3 × 10 <sup>5</sup>	1.5 × 10 <sup>6</sup>	3.3 × 10 <sup>5</sup>
<sup>106</sup> Ru	9.8 × 10 <sup>3</sup>	1.0 × 10 <sup>5</sup>	1.1 × 10 <sup>3</sup>	9.7 × 10 <sup>5</sup>
<sup>129</sup> I	6.0 × 10 <sup>5</sup>	2.3 × 10 <sup>5</sup>	3.1 × 10 <sup>5</sup>	2.1 × 10 <sup>5</sup>
<sup>131</sup> I	4.2 × 10 <sup>4</sup>	4.1 × 10 <sup>4</sup>	5.8 × 10 <sup>4</sup>	2.5 × 10 <sup>4</sup>
<sup>134</sup> Cs	4.9 × 10 <sup>5</sup>	1.4 × 10 <sup>5</sup>	2.5 × 10 <sup>5</sup>	1.2 × 10 <sup>6</sup>
<sup>135</sup> Cs <sup>a</sup>	7.0 × 10 <sup>5</sup>	3.3 × 10 <sup>5</sup>	3.0 × 10 <sup>5</sup>	1.6 × 10 <sup>6</sup>
<sup>137</sup> Cs	5.9 × 10 <sup>5</sup>	2.2 × 10 <sup>5</sup>	3.0 × 10 <sup>5</sup>	1.5 × 10 <sup>6</sup>
<sup>138</sup> Cs <sup>a</sup>	8.5 × 10 <sup>0</sup>	1.7 × 10 <sup>2</sup>	1.3 × 10 <sup>-2</sup>	1.3 × 10 <sup>-3</sup>
<sup>210</sup> Pb	4.1 × 10 <sup>4</sup>	1.4 × 10 <sup>5</sup>	1.2 × 10 <sup>4</sup>	2.4 × 10 <sup>4</sup>
<sup>212</sup> Pb <sup>a</sup>	1.6 × 10 <sup>2</sup>	3.2 × 10 <sup>3</sup>	2.1 × 10 <sup>2</sup>	8.5 × 10 <sup>-1</sup>
<sup>214</sup> Pb <sup>a</sup>	7.0 × 10 <sup>0</sup>	1.4 × 10 <sup>2</sup>	6.6 × 10 <sup>-1</sup>	1.1 × 10 <sup>-4</sup>
<sup>214</sup> Bi <sup>a</sup>	5.4 × 10 <sup>0</sup>	1.0 × 10 <sup>2</sup>	1.4 × 10 <sup>0</sup>	1.7 × 10 <sup>-2</sup>
<sup>210</sup> Po	4.9 × 10 <sup>3</sup>	9.5 × 10 <sup>4</sup>	8.2 × 10 <sup>4</sup>	1.1 × 10 <sup>5</sup>
<sup>226</sup> Ra	2.6 × 10 <sup>5</sup>	3.0 × 10 <sup>5</sup>	1.7 × 10 <sup>5</sup>	3.3 × 10 <sup>4</sup>
<sup>228</sup> Ra <sup>a</sup>	8.8 × 10 <sup>4</sup>	1.3 × 10 <sup>5</sup>	7.4 × 10 <sup>4</sup>	1.4 × 10 <sup>4</sup>
<sup>228</sup> Th <sup>a</sup>	5.4 × 10 <sup>3</sup>	1.0 × 10 <sup>5</sup>	1.5 × 10 <sup>2</sup>	1.2 × 10 <sup>3</sup>
<sup>230</sup> Th	7.9 × 10 <sup>3</sup>	1.1 × 10 <sup>5</sup>	1.7 × 10 <sup>2</sup>	2.2 × 10 <sup>3</sup>
<sup>232</sup> Th	7.9 × 10 <sup>3</sup>	1.1 × 10 <sup>5</sup>	1.7 × 10 <sup>2</sup>	2.2 × 10 <sup>3</sup>
<sup>234</sup> Th <sup>a</sup>	3.4 × 10 <sup>3</sup>	6.6 × 10 <sup>4</sup>	1.1 × 10 <sup>2</sup>	6.6 × 10 <sup>1</sup>
<sup>234</sup> U	5.6 × 10 <sup>4</sup>	1.5 × 10 <sup>5</sup>	5.7 × 10 <sup>4</sup>	2.8 × 10 <sup>5</sup>
<sup>238</sup> U	5.6 × 10 <sup>4</sup>	1.5 × 10 <sup>5</sup>	5.7 × 10 <sup>4</sup>	2.8 × 10 <sup>5</sup>
<sup>239</sup> Pu	1.0 × 10 <sup>4</sup>	1.1 × 10 <sup>5</sup>	1.6 × 10 <sup>2</sup>	8.8 × 10 <sup>3</sup>
<sup>240</sup> Pu	1.0 × 10 <sup>4</sup>	1.1 × 10 <sup>5</sup>	1.6 × 10 <sup>2</sup>	8.8 × 10 <sup>3</sup>
<sup>241</sup> Am	1.5 × 10 <sup>4</sup>	1.1 × 10 <sup>5</sup>	8.5 × 10 <sup>1</sup>	4.7 × 10 <sup>3</sup>

<sup>a</sup> Included as progeny only.



43. The dispersion of  $^3\text{H}$  and  $^{14}\text{C}$  in the environment is more complex than that of other radionuclides owing to the role of hydrogen and carbon in biological systems. These radionuclides therefore need to be treated differently from other radionuclides. As previously, the Committee has assumed these radionuclides reach equilibrium rapidly with their corresponding stable element, and used an approach based on their specific activity.

44. The specific-activity model for tritium is based on the assumption that tritium behaves as hydrogen in the environment so that tritium discharged to atmosphere exchanges with the hydrogen in water in air, soil, plants and animals. The concentration of tritiated water (HTO) and organically bound tritium (OBT) in plants is determined on the basis of the water content in plants and a partition factor that takes account of the presence of exchangeable hydrogen in the dry weight of the plant [I5]. Full details of the approach are given in the appendix. The concentrations of HTO and OBT in animal products are determined using concentration factors that relate the concentrations in these products to those in feed, drinking water and inhaled air.

45. The specific activity (or activity concentration) of  $^{14}\text{C}$  in elemental or stable carbon is determined from the discharge by taking account of dispersion in the atmosphere and the concentration of stable carbon in the atmosphere. The concentration of  $^{14}\text{C}$ , expressed in Bq/kg of stable carbon, is assumed to be the same in plants as in air. The following equation is used to calculate the concentration of  $^{14}\text{C}$  in terrestrial foods,  $C_{f,^{14}\text{C}}(x)$ , at distance  $x$  from the discharge point:

$$C_{f,^{14}\text{C}}(x) = C_{\text{air},^{14}\text{C}}(x) \cdot \frac{S_p}{S_{\text{air}}} \quad (2)$$

where  $C_{\text{air},^{14}\text{C}}(x)$  is the activity concentration of  $^{14}\text{C}$  in air at distance  $x$  (Bq/m<sup>3</sup>),  $S_p$  is the concentration of stable carbon in the crop of interest (grams of carbon per kg fresh weight of crop) and  $S_{\text{air}}$  is the concentration of stable carbon in air (grams of carbon per cubic metre of air).

Similarly the concentration of  $^{14}\text{C}$  in animal products,  $C_{f,^{14}\text{C}}$  at distance  $x$  from the discharge point is given by:

$$C_{f,^{14}\text{C}}(x) = \frac{f_c \cdot C_{\text{pasture},^{14}\text{C}}(x) \cdot S_a}{S_p} \quad (3)$$

where  $f_c$  is the fraction of feed containing  $^{14}\text{C}$  (assumed to be 1 in the methodology),  $C_{\text{pasture},^{14}\text{C}}(x)$  is the concentration of  $^{14}\text{C}$  in pasture at distance  $x$  from the discharge point (derived as for crops using equation (2)),  $S_a$  is the concentration of stable carbon in the animal product (grams of carbon per kilogram fresh weight) and  $S_p$  is the concentration of stable carbon in the pasture (grams of carbon per kilogram fresh weight of pasture).

46. The values of the model parameters forming part of the specific-activity model for  $^3\text{H}$  and  $^{14}\text{C}$  are summarized in table 6 (see the appendix for more information). The symbols used here and in the workbooks are those used in the IAEA publication describing this model for ease of reference.

Table 6. Parameters and their values associated with the specific-activity model for  $^3\text{H}$  and  $^{14}\text{C}$  (taken from [15])

<i>Parameter</i>	<i>Symbol</i>	<i>Value</i>	<i>Unit</i>
Stable carbon concentration in air	$S_{\text{air}}$	0.2	g of C/m <sup>3</sup>
Stable carbon concentration in cereals (fresh weight)	$S_p$	390	g of C /kg
Stable carbon concentration in vegetables (fresh weight)	$S_p$	30	g of C /kg
Stable carbon concentration in pasture (fresh weight)	$S_p$	100	g of C /kg
Stable carbon concentration in cow meat (fresh weight)	$S_a$	200	g of C /kg
Stable carbon concentration in cow milk (fresh weight)	$S_a$	65	g of C /kg
Fraction of feed containing $^{14}\text{C}$	$f_c$	1	—
Fractional water content of cereals (fresh weight)	$WC_p$	0.12	L/kg
Fractional water content of vegetables (fresh weight)	$WC_p$	0.92	L/kg
Fractional water content of pasture (fresh weight)	$WC_p$	0.76	L/kg
HTO:H <sub>2</sub> O water vapour pressures	$\gamma$	0.909	—
Absolute humidity	$H_a$	$6 \times 10^{-3}$	L/m <sup>3</sup>
Relative humidity	RH	0.7	—
Empirical constant	$CR_{\text{v-a}}$	0.3	—
Concentration ratio for HTO intake through milk	$CR_{a,\text{HTO}}$	0.87	(Bq/kg fresh weight) per (Bq/L)
Concentration ratio for HTO intake through meat	$CR_{a,\text{HTO}}$	0.66	(Bq/kg fresh weight) per (Bq/L)
Water equivalent factor <sup>a</sup> , cereals	$WEQ_p$	0.56	L/kg
Water equivalent factor, vegetables	$WEQ_p$	0.51	L/kg
Water equivalent factor, pasture	$WEQ_p$	0.56	L/kg
Partition factor <sup>b</sup>	$R_p$	0.54	—
Concentration ratio for OBT intake, milk	$CR_{a,\text{OBT}}$	0.24	(Bq/kg fresh weight) per (Bq/kg dry weight)
Concentration ratio for OBT intake, meat	$CR_{a,\text{OBT}}$	0.4	(Bq/kg fresh weight) per (Bq/kg dry weight)

<sup>a</sup> The water equivalent factor is the mass (kg) of water produced per unit mass (kg) of dry matter combusted.

<sup>b</sup> The ratio of the concentration of non-exchangeable organically-bound tritium in combustion water to that in tissues (e.g. leaves).

## 4. External and internal exposure

### (a) External exposure

47. The Committee considers that its previous methodology [U6] for estimating the dose from external exposure due to immersion by assuming a semi-infinite cloud of radionuclides is still appropriate. It acknowledges some limitations with this approach, most notably where activity concentrations in air are likely to be non-uniform over a distance of a few hundred metres to one kilometre from the point of discharge. However, given the distances over which the Committee's assessments are made, the application of dose coefficients for external exposure used previously, which were based on [E2], is unlikely to be a source of significant error. The dose coefficients applied in the Committee's methodology are presented in table 1.

48. The annual characteristic individual dose from immersion in the plume,  $H_{E(\text{ex,cloud}),i}$  for radionuclide,  $i$  (Sv/a) is estimated at a series of distances,  $x$  (m), from the discharge point by assuming 100% occupancy (the fraction of the time that is spent at a particular location) at locations at those distances ( $O_{\text{ann}}$  (s/a)) and applying the relevant dose coefficients for external exposure due to immersion in the plume,  $D_{\text{ex,cloud},i}$  from table 1 (Sv per (Bq s/m<sup>3</sup>)). Account is then taken of the fraction of time spent outdoors,  $O_{\text{out}}$  (dimensionless) and the shielding effect of buildings,  $L_{\text{cloud}}$  (dimensionless) as shown in equation (4) and discussed below.

$$H_{E(\text{ex,cloud}),i}(x) = C_{\text{air},i}(x) \cdot D_{\text{ex,cloud},i} \cdot O_{\text{ann}} \cdot (O_{\text{out}} + (1 - O_{\text{out}}) \cdot L_{\text{cloud}}) \quad (4)$$

Where  $C_{\text{air},i}(x)$  is the activity concentration of radionuclide  $i$  in air (Bq/m<sup>3</sup>) at location  $x$ . The annual individual dose from external exposure due to deposited material,  $H_{E(\text{ex,deposit}),i}(x)$  (Sv/a) at a distance  $x$  (m) from the discharge point is calculated from the time-integrated activity concentration (to 100 years) of the radionuclide  $i$  on soil at the location of interest,  $\dot{d}_i(x)$  (Bq s/m<sup>2</sup>), the length of the discharge,  $t_{\text{discharge}}$  (s/a) the relevant dose coefficient for external exposure due to deposition,  $D_{\text{ex,deposit},i}$  (Sv/ Bq s/m<sup>2</sup>), the fraction of time spent outdoors,  $O_{\text{out}}$  (dimensionless) and the dimensionless location factor that takes account of the shielding effect of buildings, as shown in equation (5) and discussed below.

$$H_{E(\text{ex,deposit}),i}(x) = \dot{d}_i(x) \cdot t_{\text{discharge}} \cdot D_{\text{ex,deposit},i} \cdot (O_{\text{out}} + (1 - O_{\text{out}}) \cdot L_{\text{deposit}}) \quad (5)$$

49. The Committee's previous methodology applied the dose coefficients for external exposure from radionuclides deposited on soil provided by Beck [B1]. An alternative approach was used for the Committee's 2013 Report of the levels of radiation exposure due to the nuclear accident at the Fukushima-Daiichi nuclear power station [U12] based on the model published by Petoussi-Henss et al. [P2]. The effective dose coefficients calculated using this more recent model [P2] were similar to or within a factor of two of those used previously. For the sake of simplicity and consistency with its 2013 Report [U12], the Committee decided to apply dose rate coefficients for external exposure,  $\dot{e}_{\text{dep}}$  (nSv/h per kBq/m<sup>2</sup>) from Petoussi-Henss et al. These values are based on calculations using a voxel phantom and the latest definition of effective dose [I13] (the use of the previous definition of effective dose in the methodology would make little difference to the calculated effective doses for external exposure). Where data for particular radionuclides were not available, the data set was supplemented by factors derived from the United States Federal Guidance Report No. 12 [E2].

50. Petoussi-Hens et al. [P2] modelled the geometry as an infinite mono-energetic plane source shielded by a soil layer of depth  $0.5 \text{ g/cm}^2$ . Such an assumption gives a good description of the radiation field after wet deposition on the ground and after dry deposition following the first rainfall [I15, J1]. With this geometry, the air kerma from a  $^{137}\text{Cs}$  ( $^{137\text{m}}\text{Ba}$ ) source is reduced by a factor of 0.67 compared to a plane source on the ground–air interface. The effective dose coefficients were derived assuming a constant density of air of  $1.2 \times 10^{-3} \text{ g/cm}^3$  and a soil density of  $1 \text{ g/cm}^3$ , which is considered to be representative of the upper 2 cm of soil [P2].

51. In order to model the reduction of gamma dose rates because of migration into the soil, the Committee adopted an attenuation function  $r(t)$  derived empirically from data on the migration of  $^{137}\text{Cs}$  [G2]:

$$r(t) = p_1 \cdot \exp\left(-\frac{\ln 2}{T_1} t\right) + p_2 \cdot \exp\left(-\frac{\ln 2}{T_2} t\right) \quad (6)$$

where  $p_1$  and  $p_2$  are dimensionless parameters with values derived empirically,  $T_1$  and  $T_2$  are the initial and final times, respectively, following deposition and  $t$  is the time after the deposition of interest. The parameter values in this function were determined from gamma-spectrometric analyses of over 400 soil samples taken during 1986–2003 in the areas of Germany (specifically Bavaria), the Russian Federation, Sweden and Ukraine affected by deposition from the accident at the Chernobyl nuclear power plant in 1986 (e.g. [G2, J3, L2, S2]). For the purposes of the Committee's methodology, parameter values derived for areas distant from the Chernobyl plant were applied, namely  $p_1$  was taken to be 0.5 and  $p_2$  to be 0.5;  $T_1$  was assumed to be 1.5 years while  $T_2$  was assumed to be 50 years. Thus the relationship below with  $T = 100$  years was applied to the value of the dose coefficient from deposition ( $\dot{e}_{\text{dep}}$ ) given in [P2]:

$$e_{\text{dep}} = \dot{e}_{\text{dep}} \cdot \int_0^T e^{(-\lambda t)} r(t) dt = \dot{e}_{\text{dep}} \cdot \int_0^T \left( p_1 e^{-\left(\lambda + \frac{\ln 2}{T_1}\right)t} + p_2 e^{-\left(\lambda + \frac{\ln 2}{T_2}\right)t} \right) dt \quad (7)$$

Substituting for  $p_1$ ,  $p_2$ ,  $T_1$ ,  $T_2$  in the above equations and changing from a decay constant to a half-life, the effective dose (Sv) from external exposure in year 100,  $e_{\text{dep}}$ , is given by:

$$e_{\text{dep}} = \dot{e}_{\text{dep}} \cdot \left[ \frac{0.5}{\frac{\ln 2}{t_{1/2}} + \frac{\ln 2}{1.5}} \left( 1 - e^{-\left(\frac{\ln 2}{t_{1/2}} + \frac{\ln 2}{1.5}\right)T} \right) + \frac{0.5}{\frac{\ln 2}{t_{1/2}} + \frac{\ln 2}{50}} \left( 1 - e^{-\left(\frac{\ln 2}{t_{1/2}} + \frac{\ln 2}{50}\right)T} \right) \right] \quad (8)$$

This can be simplified to

$$e_{\text{dep}} = \dot{e}_{\text{dep}} \cdot \left[ \frac{0.75 t_{1/2}}{(t_{1/2} + 1.5) \ln 2} \left( 1 - e^{-\left(\frac{\ln 2}{t_{1/2}} + \frac{\ln 2}{1.5}\right)T} \right) + \frac{25 t_{1/2}}{(t_{1/2} + 50) \ln 2} \left( 1 - e^{-\left(\frac{\ln 2}{t_{1/2}} + \frac{\ln 2}{50}\right)T} \right) \right] \quad (9)$$

As an example, for caesium-137 and caesium-134 the following values can be calculated:

$$e_{\text{dep}} \left( {}^{137}\text{Cs} + {}^{137\text{m}}\text{Ba} \right) = 1.55 \times 10^{-7} \text{ Sv}/(\text{Bq}/\text{m}^2) \quad (10)$$

$$e_{\text{dep}} \left( {}^{134}\text{Cs} \right) = 6.23 \times 10^{-8} \text{ Sv}/(\text{Bq}/\text{m}^2) \quad (11)$$

52. Despite differences in climate, little variation in indoor occupancies has been found between countries and there is no evidence of a significant difference due to climate [A1]. Studies show that indoor occupancies range from around 84 to 91% [G1, O2]. The Committee considered that values of between 70% (for an outdoor worker) and 90% (for pensioners and indoor workers) were appropriate for a Japanese population [U12]. In accordance with its previous methodology, the Committee assumed an indoor occupancy factor of 80% [U6]. In equations (4) and (5) above the outdoor occupancy  $O_{\text{out}}$  is used; this is simply a fractional value and is  $1 - 0.8 = 0.2$ .

53. People indoors receive some protection from external exposure due to gamma-emitting radionuclides in the plume as it passes overhead. The reduction in ambient dose equivalent rate depends on the nature and structure of the building as well as on the energy of the radiation. A number of studies of the shielding effect of various types of buildings have been published, particularly following the Chernobyl accident [E2]. For example, the work of Le Grand [L1] and Jacob and Meckbach [J1, J2] indicated that shielding factors (i.e. the ratio of the ambient dose equivalent rate indoors to that outdoors) for radiation from airborne radionuclides ranged from 0.01 to 0.7 for single-family houses in various European countries. For multi-storey buildings the shielding factor varies with storey, with the lowest values in the basement and first storey and the highest value for the top storey. Le Grand [L1] estimated that shielding factors appropriate for an airborne plume with photon energy of 0.68 MeV ranged from 0.01 to 0.1 for the ground floor and from 0.09 to 0.4 for the upper floors of buildings. For its methodology, the Committee has selected a shielding factor of 0.2 for radionuclides in the plume, being within the range applicable to single and multi-storey buildings.

54. The UNSCEAR 1982 Report [U4] provided an overview of shielding factors appropriate for deposited radionuclides, with values ranging from 0.05 in office buildings, 0.2 in masonry homes, and 0.4 in wooden buildings. This information was based on work by Burson and Profio, which showed a range of shielding factors depending on the nature of the building, with the lowest factors being for basements of large multi-storey buildings [B8]. The United States Nuclear Regulatory Commission [N6] and others have suggested a generic shielding factor of 0.5 for regulatory purposes, which it considers appropriate for photon energies above a few hundred kiloelectronvolts [E2]; for photons of lower energy, use of such a value may considerably overestimate the dose equivalent [K6]. In their assessment of the radiation exposure of the population of the United States of America [N3, S1], the National Council on Radiation Protection and Measurements (NCRP) applied a shielding factor of 0.59 ( $\pm 6\%$ ) for terrestrial gamma radiation, which it considered to be appropriate for photon energies of greater than a few hundred kiloelectronvolts.

55. Location factors are used to express the ratio of external exposures in terms of ambient dose equivalent rate at a specific location to the ambient dose equivalent at the location for which calculated or measured ambient dose equivalent was obtained (for example, this might be between the exposures outdoors in an urban and a rural environment). This is a broader term than shielding factor which just allows for the reduction of ambient dose equivalent from being indoors. For the purposes of this methodology, the two terms can be considered to be equivalent, because it is the reduction in external exposures from being indoors that is relevant. Golikov et al. evaluated the location factors for gamma radiation in air in rural and urban environments in the Russian Federation five years after the Chernobyl accident [G2]. In urban areas, they derived location factors for living areas that varied from 0.01 for a multi-storey house to 0.09 for a wooden house, while they estimated the factor for buildings where

people work to be around 0.02. In rural areas, location factors for living areas ranged from 0.02 (for a multi-storey house) to 0.13 (for a single-storey wooden building). This work formed the basis for the time-dependent location factors used in the Committee's 2013 Report on the levels and effects of radiation exposure due to the nuclear accident at the Fukushima-Daiichi nuclear power station [U12]. Three different time-dependent location factors were used for that assessment: (a) for paved external surfaces, (b) for non-paved external surfaces, and (c) for inside buildings. This time dependence is important when assessing exposures due to an accident. However, for routine releases it is the dose in the 100th year of continuous discharge that is of interest and the effect of using a time-dependent location factor is small compared to differences in location factors for different building types. These results also show a greater degree of shielding from deposited radionuclides than from radionuclides in the plume, and this is reflected in the Committee's choice of values for its methodology. In accordance with its previous methodology [U6], the Committee has used a shielding (location) factor of 0.1 to allow for the reduction in ambient dose equivalent from external exposure due to deposited material while indoors. This value was chosen as representative of occupancy in a single-storey building and was considered to be reasonably consistent with the result that would be obtained if an approach based on time-dependent location factors had been used.

### (b) *Internal exposure from inhalation*

56. As previously, the Committee uses a standard approach to assess the internal exposure from inhalation of radionuclides in the air following discharges to atmosphere. This approach uses the estimated activity concentration of a radionuclide in air (section III.A.2 above), an appropriate breathing rate and the relevant dose coefficient for intake by inhalation (table 1).

57. The Committee continues to use a nominal adult breathing rate of 20 m<sup>3</sup>/d [U7] in its methodology to maintain consistency with previous assessments, recognizing differences between this value and that used by ICRP to derive dose coefficients. As discussed earlier, the Committee considers that the dose coefficients for inhalation given in ICRP Publication 119 [I14] using the ICRP model of the respiratory tract [I11] continue to be appropriate (table 1). No account is taken of any reduction in activity concentrations in air when people are indoors because the Committee considers this to be a second-order effect that will not have a significant effect on the estimated doses.

58. A different approach is needed for the inhalation of isotopes of radon. In the UNSCEAR 2006 Report, the Committee considered a number of issues related to the assessment of doses from the inhalation of radon and its short-lived progeny [U9]. It concluded that it should continue to use a value for the radon dose coefficient of 9 nSv per (Bq h)/m<sup>3</sup> for this methodology, with equilibrium factors (the ratio between the activity of the short-lived radon progeny and the activity that would be at equilibrium with the radon parent) of 0.6 for radon outdoors and 0.4 for radon indoors (indoor occupancy being 80% as discussed earlier) to calculate annual effective doses from inhalation of radon and its short-lived progeny (see the appendix for more details).

### (c) *Internal exposure from ingestion*

59. Members of the public may be exposed through ingestion of food that contains radionuclides resulting from discharges to atmosphere. As indicated in section III.A.3, radionuclides discharged to atmosphere may be transferred to human food by a number of routes. The annual effective dose from the ingestion of food,  $f$ , containing radionuclide,  $i$ , at distance  $x$  (m) from the discharge point in region  $r$ , ( $H_{E(ing),f,r,i}(x)$ ) (Sv/a) is given by equation (12):

$$H_{E(\text{ing}),f,r,i}(x) = C_{f,i}(x) \cdot D_{\text{ing},i} \cdot F_{\text{local}} \cdot I_{f,r} \quad (12)$$

where  $D_{\text{ing},i}$  (Sv/Bq) is the effective dose coefficient for ingestion of radionuclide  $i$  as given in table 1;  $F_{\text{local}}$  is the fraction of food that is locally produced (dimensionless);  $I_{f,r}$  is the average consumption rate of food  $f$  in region  $r$  (kg or L per year) as discussed below;  $C_{f,i}$  is the activity concentration of radionuclide  $i$  in terrestrial food  $f$  at distance  $x$  from the discharge point (Bq/kg) given by:

$$C_{f,i}(x) = C_{f,\text{unit},i} \cdot \dot{d}_i(x) \quad (13)$$

where  $C_{f,\text{unit},i}$  is the activity concentrations in foodstuffs integrated to 100 years for continuous deposition at a rate of 1 Bq/(m<sup>2</sup> s) for one year (Bq/kg per Bq/(m<sup>2</sup> s)) given in table 5 and  $\dot{d}_i(x)$  is the deposition rate at distance  $x$  of radionuclide  $i$  (Bq/(m<sup>2</sup> s)). The food contamination monitoring and assessment programme (GEMS/Food) database for 2012 — part of the WHO Global Environment Monitoring System — formed the basis for the population-weighted consumption rates used by the Committee to calculate doses from ingestion for each UNEP region [W2]. For the Committee's methodology, the World Health Organization (WHO) combined the data for specified food groups and reconfigured them for the UNEP regions and subregions (figure II). The resulting values of  $I_{f,r}$  for terrestrial foods are presented in table 7. World-average values have also been derived; these are the averages of the values for each region weighted by the population densities given in table 3. As discussed in paragraph 11, for the estimation of characteristic individual doses, it is assumed that only 25% of foods consumed are produced locally ( $F_{\text{local}}$  is 0.25). However in estimating collective doses, people are assumed to obtain 100% of their food from the area where they live ( $F_{\text{local}}$  is 1.0), this assumption is considered reasonable because collective doses are estimated for areas of 30,000 km<sup>2</sup> or more.

Table 7. Annual average per caput consumption rates of terrestrial foods by UNEP region

UNEP region	Annual average per caput consumption rate <sup>a</sup> (kg) for each food type			
	Cereals	Vegetables and fruit	Milk and dairy products	Meat and offal
Africa	130	220	31	17
Asia and Pacific	140	240	45	30
Europe	110	280	120	65
Latin America and Caribbean	110	210	77	63
North America	88	260	120	100
West Asia	140	180	43	34
World average <sup>b</sup>	130	230	65	44

<sup>a</sup> Values are rounded to two significant figures in order not to imply great precision.

<sup>b</sup> World-average values are the averages of the values for each region weighted by the population densities given in table 3.

60. The Committee considered that the inclusion of all food groups and all 13 regions in the WHO GEMS/Food [W2] would imply a level of accuracy that was inconsistent with other aspects of the revised methodology. Although the dietary data in GEMS/Food were based on clusters of countries with similar dietary habits, this clustering would not have been consistent with other information for UNEP regions used to calculate doses (e.g. population distribution and energy production). Therefore, a simplified approach was used based on the UNEP regions shown in figure II; any differences in intakes and hence doses because of this simplification were deemed commensurate with those due to other simplifying assumptions made in the methodology.

61. As discussed in section III.A.3, activity concentrations in foods integrated to 100 years for continuous deposition at a rate of  $1 \text{ Bq}/(\text{m}^2 \text{ s})$  for one year have been determined using combined food- and radionuclide-specific transfer parameters. These estimated concentrations take account of a range of physical processes that do not depend on the chemical element (such as interception by plant surfaces) and biochemical factors that do depend on the chemical element, such as root uptake and transfers from animal feed to meat and milk. For tritium and carbon-14, combined transfer parameters are defined per unit activity concentration in air based on a specific-activity approach. The intake of radionuclides is then determined using the population-weighted food consumption rates for the different geographical regions. This is a slightly different approach from that used previously by the Committee, where simple global average intakes were used, (see electronic attachments 1 and 2); however, the overall difference in the resulting dose estimates is not significant.

62. A limited sensitivity analysis was carried out to determine the applicability of the generic food-chain model for different regions of the world and whether the foods and related consumption rates were appropriate. This analysis is outlined in electronic attachment 4 and the Committee concluded that it was reasonable to use the food-chain model and the consumption data by geographical region for the purposes of assessing worldwide exposures.

## B. Assessment of doses from discharges to a freshwater environment

63. The extent of dispersion of radionuclides in freshwater bodies varies significantly depending on characteristics of the water body, particularly the volume of the body into which the discharge occurs and the water flows. However, the Committee decided that there would be value in developing generic dose-calculation factors that provide an estimate of the integrated activity concentrations in water from a discharge of each radionuclide for a year, allowing for dispersion within different types of water body. An approach for estimating individual doses and for calculating regional components of collective dose was developed on this basis. (As discussed previously, for discharges to rivers using the simple, generic approach adopted in the methodology, it is not possible to distinguish between local and regional components of collective dose).

64. The following exposure pathways are considered for discharges to freshwater bodies (see figure I):

- (a) Internal exposure from ingestion of radionuclides in drinking water;
- (b) External exposure (beta and gamma emitters) from radionuclides in sediments deposited on the riverbank;
- (c) Internal exposure from ingestion of radionuclides incorporated into freshwater fish;
- (d) Internal exposure from ingestion of radionuclides incorporated into terrestrial foods because of irrigation.

65. Other exposure pathways such as internal exposure from inadvertent ingestion of water and sediment, external exposure when swimming or boating, and external exposure from radionuclides deposited on irrigated land, are also possible. However, the exposure pathways above have been found to be the largest contributors to individual and collective doses following continuous discharges to water bodies [J5]. The external exposure pathway, (b) above, is included only in the calculation of characteristic individual dose. This pathway is unlikely to be a significant contributor to collective doses from aquatic discharges from nuclear power stations and reprocessing plants, as demonstrated by



past assessments (e.g. [J6]). Individual doses are estimated from individual consumption rates and occupancy data, while collective doses from ingestion are calculated using region-specific data on total fish catches, water abstraction and agricultural production. Thus, the resulting individual and collective dose estimates are not directly linked in the way that they are for discharges to atmosphere. In effect, collective doses from discharges to a freshwater body are based on the total usage of water or total amount of produce from the generic water body, irrespective of the location of people.

66. The Committee's methodology initially considered three types of environment for assessing doses arising from aquatic discharges to freshwater bodies: (a) lakes, (b) small rivers and (c) large rivers. However, the Committee agreed that the dispersion of aquatic discharges from facilities on the shores of a large lake can be assessed using the same approach as for large rivers. Given the differences in characteristics and hence dispersion in different rivers and lakes throughout the world, the Committee agreed that the distinction between lakes and large rivers was a second-order effect and did not need to be considered further for its purposes. It should be noted that the Committee's methodology does not apply to closed lake systems, i.e. those without rivers feeding into or out of the lake.

67. Two types of river are defined to allow for the range of discharge conditions that may occur. For example, inland nuclear facilities (with the exception of mines and mills) are assumed to discharge into large rivers, and non-nuclear facilities and mines into small rivers. The dimensions and flow rates associated with a range of rivers into which nuclear and other facilities discharge were reviewed in order to select appropriate parameter values for the Committee's methodology.

## 1. Dispersion of radionuclides in freshwater bodies

68. The Committee's methodology for deriving activity concentrations of radionuclides following their discharge into freshwater bodies assumes that complete mixing occurs immediately. This is a simplification because for rivers complete dilution would occur over some tens of kilometres downstream, the actual distance depending on the width of the river, which is in turn related to the volumetric flow rate. Nevertheless, significant mixing does occur over relatively short distances. As an illustration of this, table 8 shows results from using the NCRP screening model, which is designed for the purpose of demonstrating compliance with environmental standards for discharges of radionuclides [N2]. The table indicates that the activity concentration in unfiltered water assuming complete mixing of the radionuclide across the total width of the river essentially equals the actual activity concentration in unfiltered water in the plume (i.e. the value of the partial mixing correction factor approaches one) for rivers up to a width of around 100 m at a downstream distance of around 5 km. For wider rivers, the value of the correction factor would be of the order of one to five at this distance; complete mixing would, however, occur over a distance of around 100 km for such rivers. Specific information is available for the Techa–Iset–Tobol–Irtysh–Ob river system in the Russian Federation [N5]. This is a complex river system and complete mixing does not occur until some distance downstream. (At 27 km downstream there was not complete mixing with nearly a factor of 5 variation in measured concentrations at different locations across the river.) However, the abstraction point for drinking water is likely to be at some distance downstream from the discharge point and fish will be caught over large sections of the river. Given this and the generic nature of the revised methodology, the distances over which collective doses are calculated, and other uncertainties associated with the approach, the Committee considered it unlikely that assuming complete mixing would significantly affect the collective dose estimate. Although the dose to an individual obtaining their drinking water from the immediate vicinity of a source would depend on the location of the abstraction point relative to the point of discharge, because of the generic nature of the approach, assuming complete mixing is also appropriate for individual dose estimation.

Table 8. Correction factors to complete mixing in a river plume as a function of downstream distance from the point of discharge for different river widths [N2]

The correction factor for partial mixing represents the ratio of the activity concentration in water in the plume to the activity concentration in water if, at the same point, complete mixing in the total width of the river were assumed. Complete mixing would give a value of 1

Distance downstream (km)	Partial mixing correction factor at various river widths <sup>a</sup>				
	10 m	50 m	100m	200 m	400 m
0.1	3.2	6	8	10	12
1	1	2.4	3.2	5	8
5	1	1	1.6	2.6	3.6
10	1	1	1	1.9	3
50	1	1	1	1	1.4
100	1	1	1	1	1

<sup>a</sup> Values are rounded to one decimal place.

69. For the purposes of the Committee's methodology, the activity concentrations of radionuclides in river water are therefore derived assuming that the discharged radionuclides are dispersed uniformly across the river. Under these conditions, the activity concentrations in water depend upon the volumetric flow rate of the river alone, which, in turn, is primarily determined by the width of the river. Thus, it is assumed that, for all freshwater pathways, the activity concentration in unfiltered freshwater is given by:

$$C_{uw,i} = Q_i / F \quad (14)$$

where  $C_{uw,i}$  is the activity concentration of radionuclide,  $i$ , in unfiltered water at the discharge point ( $\text{Bq}/\text{m}^3$ );  $Q_i$  is the discharge rate of radionuclide,  $i$ , ( $\text{Bq}/\text{s}$ ) and  $F$  is the volumetric flow rate of the river at the point of discharge ( $\text{m}^3/\text{s}$ ). The activity concentrations of radionuclides in filtered water are determined from the suspended sediment load and the radionuclide-specific partition factors for freshwater environments. These activity concentrations are then used, for example, to derive activity concentrations of radionuclides in freshwater fish. To derive activity concentrations of radionuclides in drinking water, a water treatment factor is applied.

70. For the large river (and as noted earlier, for lakes), a width of 240 m and flow rate of  $1,000 \text{ m}^3/\text{s}$  are assumed for the purposes of the methodology. Table 9 gives some illustrative flow rates and other dimensions for a range of rivers of different sizes throughout the world. The values assumed for a large river are consistent with the data for major sections of the Rhône, Loire, Danube and Rhine; these are rivers into which a number of nuclear installations discharge radionuclides. They are also similar to other major rivers throughout the world, as shown in table 9, although some rivers have greater flows, notably the Amazon.

Table 9. Flow rates and dimensions of some typical rivers and those assumed in the methodology

<i>River</i>	<i>Country</i>	<i>Flow rate (m<sup>3</sup>/s)</i>	<i>Length in specified country (km)</i>	<i>Width (m)</i>	<i>Depth (m)</i>
Amazon <sup>a</sup>	Peru, Columbia, Brazil	$2.0 \times 10^5$	$6.9 \times 10^3$		
Danube <sup>b</sup>	Germany, Austria, Slovakia, Hungary, Croatia, Serbia, Bulgaria, Romania, Moldova, Ukraine	$3 \times 10^3$	$3 \times 10^3$	$5 \times 10^2$	6
Ganges <sup>a</sup>	India, Bangladesh	$1.6 \times 10^4$	$2.5 \times 10^3$		
Kennet (tributary of Thames)	United Kingdom	$1 \times 10^1$	$3.3 \times 10^1$	17	1
Loire <sup>c</sup>	France	$7.8 \times 10^2$	$5.6 \times 10^2$	$2.6 \times 10^2$	3
Mississippi <sup>a</sup>	United States of America	$1.6 \times 10^4$	$3.7 \times 10^3$		
Nile <sup>d,e</sup>	Egypt	$1.8 \times 10^3$	$1.5 \times 10^3$		
Paraná <sup>f</sup>	Brazil, Paraguay, Argentina	$1.7 \times 10^4$	$4.8 \times 10^3$	$1.8 \times 10^4$	
Pearl	China <sup>g</sup>	$2.2 \times 10^3$	$2.2 \times 10^3$		
Rhône <sup>c</sup>	France	$1.2 \times 10^3$	$4.0 \times 10^2$	$2 \times 10^2$	7
Thames <sup>h</sup>	United Kingdom	$5 \times 10^1$	$2.3 \times 10^2$	50	2
Yangtze	China <sup>g</sup>	$3.2 \times 10^4$	$6.3 \times 10^3$		
Yellow	China <sup>g</sup>	$2.1 \times 10^3$	$5.5 \times 10^3$		
ASSUMED VALUES IN THE METHODOLOGY					
Methodology—small river <sup>i</sup>		$1 \times 10^1$	$1 \times 10^2$	30	1
Methodology—large river <sup>i</sup>		$1 \times 10^3$	$5 \times 10^2$	240	4

<sup>a</sup> Milliman and Farnsworth (2011) [M2].

<sup>b</sup> Maringer (2000) [M1].

<sup>c</sup> Smith and Simmonds (2009) [S8].

<sup>d</sup> Wahaab and Badawy (2004) [W1].

<sup>e</sup> Hamza (2014) [H1].

<sup>f</sup> Encyclopaedia Britannica (Parana-River) [E3].

<sup>g</sup> Information provided by the Chinese delegation.

<sup>h</sup> Hilton et al. (2003) [H4].

<sup>i</sup> The dimensions of the small river are similar to those of the River Kennet in the United Kingdom; those of the large river are similar to those of major sections of the Rhône and Loire in France and other rivers.

71. For the small river, a flow rate of  $10 \text{ m}^3/\text{s}$  (width of 30 m and depth of 1 m) is assumed in the methodology. This is similar to that of the River Kennet in the United Kingdom.

72. The measured suspended sediment loads of the Colorado and Mississippi Rivers have been shown to vary by three or more orders of magnitude [H2, S10]. However, a value of  $5 \times 10^{-4} \text{ t/m}^3$  is considered to be appropriately representative within this range and is assumed for large rivers; this also agrees with other data presented for the Colorado River [V1].

73. The suspended sediment loads of small rivers also vary by several orders of magnitude, depending on flow rate. For low flow rates, values in the range  $2$  to  $5 \times 10^{-5}$  t/m<sup>3</sup> may be considered to be typical (see, for example, Hejduk and Banasik [H3]). A value of  $2 \times 10^{-5}$  t/m<sup>3</sup> was adopted for the purposes of this methodology.

## 2. Behaviour of radionuclides in a freshwater environment

### (a) *Transfers in freshwater environments*

74. The key element-specific parameters that account for the transfer of radionuclides in an aquatic environment are concentration factors that relate the concentrations of elements in fish to their concentrations in water, and partition coefficients that relate the distribution of elements between sediment and water. Standard compilations of these data [I3, I5] have also been updated since the Committee's assessments were issued in the UNSCEAR 2000 and 2008 Reports [U6, U10, U11].

75. The activity concentration of a radionuclide in an aquatic food is derived by applying an equilibrium concentration factor, defined as the ratio of the concentration of the radionuclide in the aquatic food (fresh weight) at equilibrium to its concentration in water (Bq/kg per Bq/L) (note in some compilations of data the term "bioaccumulation factor" is used for these values). The most recent international compilation of concentration factors for freshwater environments [I5] provides transfer parameter values appropriate for equilibrium conditions. Where the available data permit, ranges of observed values are presented together with mean values. Those mean values have been used for the purposes of this methodology supplemented by data from other sources, where necessary; the values adopted by the Committee for this methodology are given in table 10.

76. The transfer of radionuclides between the water column and suspended and bottom sediments depends on both the characteristics of the water body and the chemical and physical characteristics of the radionuclides themselves. The partition coefficient,  $K_d$ , relates to the partitioning of radionuclides between the solid and aqueous phases and is expressed as the ratio of the activity of a radionuclide per unit dry weight of sediment at equilibrium to the activity of that radionuclide per unit volume of water (Bq/kg per Bq/L) (this can also be referred to as a distribution coefficient). The most recent international compilation of  $K_d$  values for freshwater environments is presented in [I5], although the Committee also used values from other sources, where data were not available in [I5]. The data used are given in table 10 and are intended to represent generic best estimates, recognizing that  $K_d$  values vary depending on the characteristics of the water body.

Table 10. Values of radionuclide-specific parameters used in the model for freshwater environments

Radionuclide	Concentration factor for freshwater fish, $B_{fish}$ (L/kg) (fresh weight)	Activity concentrations in sediment (dry weight) in the 100th year of continuous discharge at 1 Bq/s (Bq/kg)		Water treatment factor $F_{WT}$ [B7] <sup>a</sup>	Partition coefficient, $K_d$ (m <sup>3</sup> /t)
		Small river [S8]	Large river [S8]		
<sup>3</sup> H (HTO and OBT)	$1.0 \times 10^0$ [N2]	0	0	$1.0 \times 10^0$	0 [I2]
<sup>14</sup> C	$4.0 \times 10^5$ [I5]	$5.0 \times 10^{-4}$	$5.0 \times 10^{-6}$	$1.0 \times 10^0$	$5.0 \times 10^0$ [I2]
<sup>35</sup> S	$8.0 \times 10^2$ [N2]	$2.0 \times 10^{-2}$	$1.8 \times 10^{-4}$	$5.4 \times 10^{-1}$	$2.0 \times 10^2$ [B4]
<sup>54</sup> Mn	$2.4 \times 10^2$ [I5]	$3.1 \times 10^0$	$2.0 \times 10^{-3}$	$3.6 \times 10^{-1}$	$7.9 \times 10^4$ [I5]
<sup>58</sup> Co	$7.6 \times 10^1$ [I5]	$2.3 \times 10^0$	$1.9 \times 10^{-3}$	$5.4 \times 10^{-1}$	$4.4 \times 10^4$ [I5]
<sup>60</sup> Co	$7.6 \times 10^1$ [I5]	$2.3 \times 10^0$	$1.9 \times 10^{-3}$	$5.4 \times 10^{-1}$	$4.4 \times 10^4$ [I5]
<sup>65</sup> Zn	$3.4 \times 10^3$ [I5]	$4.9 \times 10^{-2}$	$4.0 \times 10^{-4}$	$5.4 \times 10^{-1}$	$5.0 \times 10^2$ [I2]
<sup>90</sup> Sr	$2.9 \times 10^0$ [I5]	$1.2 \times 10^{-1}$	$7.5 \times 10^{-4}$	$8.1 \times 10^{-1}$	$1.2 \times 10^3$ [I5]
<sup>106</sup> Ru	$5.5 \times 10^1$ [I5]	$2.0 \times 10^0$	$1.9 \times 10^{-3}$	$5.4 \times 10^{-1}$	$3.2 \times 10^4$ [I5]
<sup>129</sup> I	$3.0 \times 10^1$ [I5]	$4.0 \times 10^{-1}$	$1.4 \times 10^{-3}$	$8.1 \times 10^{-1}$	$4.4 \times 10^3$ [I5]
<sup>131</sup> I	$3.0 \times 10^1$ [I5]	$4.0 \times 10^{-1}$	$1.4 \times 10^{-3}$	$8.1 \times 10^{-1}$	$4.4 \times 10^3$ [I5]
<sup>134</sup> Cs	$2.5 \times 10^3$ [I5]	$1.8 \times 10^0$	$1.9 \times 10^{-3}$	$8.1 \times 10^{-1}$	$2.9 \times 10^4$ [I5]
<sup>137</sup> Cs	$2.5 \times 10^3$ [I5]	$1.8 \times 10^0$	$1.9 \times 10^{-3}$	$8.1 \times 10^{-1}$	$2.9 \times 10^4$ [I5]
<sup>210</sup> Pb	$2.5 \times 10^1$ [I5]	$8.3 \times 10^{-1}$	$1.7 \times 10^{-3}$	$5.4 \times 10^{-1}$	$1.0 \times 10^4$ [K1]
<sup>212</sup> Pb	$2.5 \times 10^1$ [I5]	$6.3 \times 10^{-1}$	$1.5 \times 10^{-3}$	$5.4 \times 10^{-1}$	$1.0 \times 10^4$ [K1]
<sup>214</sup> Pb	$2.5 \times 10^1$ [I5]	$1.3 \times 10^{-3}$	$2.1 \times 10^{-4}$	$5.4 \times 10^{-1}$	$1.0 \times 10^4$ [K1]
<sup>210</sup> Po	$3.6 \times 10^1$ [I5]	$2.2 \times 10^0$	$1.9 \times 10^{-3}$	$5.4 \times 10^{-1}$	$4.0 \times 10^4$ [S3]
<sup>226</sup> Ra	$4.0 \times 10^0$ [I5]	$6.4 \times 10^{-1}$	$1.6 \times 10^{-3}$	$5.4 \times 10^{-1}$	$7.4 \times 10^3$ [I5]
<sup>228</sup> Th	$6.0 \times 10^0$ [I5]	$4.0 \times 10^0$	$2.0 \times 10^{-3}$	$3.0 \times 10^{-1}$	$1.9 \times 10^5$ [I5]
<sup>230</sup> Th	$6.0 \times 10^0$ [I5]	$4.0 \times 10^0$	$2.0 \times 10^{-3}$	$3.0 \times 10^{-1}$	$1.9 \times 10^5$ [I5]
<sup>232</sup> Th	$6.0 \times 10^0$ [I5]	$4.0 \times 10^0$	$2.0 \times 10^{-3}$	$3.0 \times 10^{-1}$	$1.9 \times 10^5$ [I5]
<sup>234</sup> Th	$6.0 \times 10^0$ [I5]	$3.9 \times 10^0$	$2.0 \times 10^{-3}$	$3.0 \times 10^{-1}$	$1.9 \times 10^5$ [I5]
<sup>234</sup> U	$9.6 \times 10^{-1}$ [I5]	$5.0 \times 10^{-3}$	$4.9 \times 10^{-5}$	$3.0 \times 10^{-1}$	$5.0 \times 10^1$ [I2]
<sup>238</sup> U	$9.6 \times 10^{-1}$ [I5]	$5.0 \times 10^{-3}$	$4.9 \times 10^{-5}$	$3.0 \times 10^{-1}$	$5.0 \times 10^1$ [I2]

Radionuclide	Concentration factor for freshwater fish, $B_{fish}$ (L/kg) (fresh weight)	Activity concentrations in sediment (dry weight) in the 100th year of continuous discharge at 1 Bq/s (Bq/kg)		Water treatment factor $F_{WT}$ [B7] <sup>a</sup>	Partition coefficient, $K_d$ (m <sup>3</sup> /t)
		Small river [S8]	Large river [S8]		
<sup>239</sup> Pu	$3.0 \times 10^1$ [I2]	$4.1 \times 10^0$	$2.0 \times 10^{-3}$	$2.7 \times 10^{-1}$	$2.4 \times 10^5$ [I5]
<sup>240</sup> Pu	$3.0 \times 10^1$ [I2]	$4.1 \times 10^0$	$2.0 \times 10^{-3}$	$2.7 \times 10^{-1}$	$2.4 \times 10^5$ [I5]
<sup>241</sup> Am	$2.4 \times 10^2$ [I5]	$3.5 \times 10^0$	$2.0 \times 10^{-3}$	$2.7 \times 10^{-1}$	$1.2 \times 10^5$ [I5]

<sup>a</sup> The water treatment factors used are based on flocculation, coagulation, clarification and rapid sand filtration. Where data were not given for a specific element in Brown et al. [B7], an analogue approach was used.

## (b) *Transfers from fresh water to terrestrial environments*

77. The irrigation of crops with fresh water may lead to the transfer of radionuclides from a freshwater to a terrestrial environment. This exposure pathway was not included in the Committee's previous methodology but, given the importance of irrigation of crops throughout the world, the Committee decided that it should be considered. In general terms, the rate at which radionuclides present in fresh water are deposited on crops and soil is estimated from information on the rate of irrigation and the length of the crop-growing season. This information is then used to estimate the resultant activity concentrations of radionuclides in terrestrial crops from their activity concentrations in fresh water and the derived calculation factors for their activity concentrations in food per unit deposition rate.

78. There are many different types of irrigation. The most important for the transfer of radionuclides to crops is sprinkler or spray irrigation because radionuclides in the water will be deposited directly on the surface of the plants. Other types of irrigation where water is deposited on the surface of the soil give rise to lower transfers and so were not included in the Committee's methodology. Although there are obvious differences in the behaviour of radionuclides that are deposited on the surface of plants during sprinkler irrigation and that of radionuclides deposited by wet and dry deposition from the atmosphere, the Committee considered that the differences in the overall transfers to plants are a second-order effect in the context of the objectives of the methodology. Therefore, the values of the transfer factors for deposition from the atmosphere are assumed to apply also to irrigation. These parameters include the transfers from plant surfaces and from uptake from the soil. The Committee recognizes that there may be some overestimation in assuming that the rate of uptake from irrigation water is equivalent to that from deposition from the atmosphere, given that greater losses from plant surfaces may be anticipated for the higher deposition rates characteristic of irrigation.

79. The Food and Agriculture Organization of the United Nations (FAO) publishes statistics on water resources in its AQUASTAT database [F4]. The information indicates that 40% of global food production involves irrigation. Data are available on the overall rates of abstraction of water by source (whether from surface or groundwater). Information is available on the overall rate of water abstracted for irrigation, but not on the fraction of irrigation water that is drawn from each source. In the absence of this information, it is assumed that the fraction of water used for irrigation of the total amount abstracted is the same for both sources. Using data from the AQUASTAT database, the fraction of surface water withdrawn for irrigation and the area irrigated per unit volume of water was obtained for each region as shown in table 11, which also gives world-average values. The appendix describes how these values are used in the methodology.

80. From this table, it is clear that, with the exception of West Asia, there is only limited abstraction of water from surface water.

81. The International Commission on Irrigation and Drainage provides data on the area of land under different types of irrigation for 45 countries [I7]. The Committee has used these data to derive the fraction of land under sprinkler/spray irrigation for each region and an average for the world (see table 12). The values in this table are for various times between 1999 and 2012.

82. The fractions given in table 12 are used in the methodology together with the calculated activity concentrations of radionuclides in water and the abstraction rate for irrigation to derive concentrations of radionuclides in foods and hence to estimate individual and collective doses. The Committee agreed that irrigation should only be considered for vegetables and grain and only for large rivers. For small

rivers with low abstraction rates, it is unlikely that there is significant irrigation. Although other crops are likely to be irrigated, the most important are leafy vegetables and grain [F4]. The irrigation of pasture is important in some parts of the world (such as parts of the United States) but it is rare in other major areas with significant cattle production, such as Brazil and Argentina, and so it is not included in the methodology.

Table 11. The fraction of water for irrigation withdrawn from surface waters and the total area irrigated per unit volume of surface water available

Region	Parameter	
	Fraction of water for irrigation withdrawn from surface waters (dimensionless)	Area irrigated per unit volume of withdrawn water ( $m^2 a / m^3$ )
Africa	$2.7 \times 10^{-2}$	$6.0 \times 10^{-1}$
Asia and Pacific	$9.4 \times 10^{-2}$	$7.9 \times 10^{-1}$
Europe	$1.2 \times 10^{-2}$	$1.9 \times 10^0$
Latin America and Caribbean	$1.0 \times 10^{-2}$	$8.2 \times 10^{-1}$
North America	$2.4 \times 10^{-2}$	$1.3 \times 10^0$
West Asia	$5.7 \times 10^{-1}$	$4.7 \times 10^{-1}$
World average	$3.9 \times 10^{-2}$	$8.5 \times 10^{-1}$

Table 12. Fraction of irrigated land that is spray-irrigated (based on information from [I7])

Region	Fraction
Africa	0.2
Asia and Pacific	0.1
Europe	0.4
Latin America	0.2
North America	0.5
West Asia	0.3
World average	0.2

### (c) Specific activity models for tritium and carbon-14 in fresh water

83. The Committee has adopted a specific-activity approach for assessing the transfer of tritium and carbon-14 in a freshwater environment. This is the same approach as it used previously and as described for a terrestrial environment. The assumption that equilibrium conditions exist, which is implicit in the specific-activity model, is considered to be a good approximation for most aquatic compartments in the model [E1, K5]. The model adopted is that described in [I5] in which activity concentrations of tritium in fish are determined on the basis of the HTO concentration in the water column and the fractional water content of fish. The fractional water content is found to be 0.78 L/kg for most fish that form part of the human diet [I5]. The concentration of organically bound tritium (OBT) is also taken into account. The relevant equations and parameter values used in the methodology are given in the appendix.



84. A specific activity approach is also applied to estimate the total tritium concentration in soil water by taking account of the activity concentration of tritium in irrigation water, the rate of irrigation and the effect of mixing with water reaching the soil from precipitation [C1]. The equations and data applied are presented in the appendix.

85. For discharges to aquatic bodies, the specific activity of dissolved inorganic carbon is assumed to be in equilibrium within the part of the environment of interest. The methodology includes a simplified approach based on a dynamic model developed by Sheppard et al. [S4, S5] with some modification to apply it to irrigation based on the approach outlined in [C1]. The equations and parameter values applied are given in the appendix.

### 3. External and internal exposure

#### (a) *External exposure from radionuclides in riverbank sediments*

86. Annual individual doses from external exposure during occupancy of riverbanks are calculated using the time-integrated activity concentrations of radionuclides in sediments, the dose coefficients for external exposure from surface deposits and the amount of time spent on riverbanks. This exposure pathway is only considered for the calculation of the characteristic individual dose.

87. For discharges to fresh water bodies, activity concentrations of radionuclides in sediments at a distance of 5 km downstream from the discharge point are used for the purpose of calculating characteristic individual doses from external exposure due to radionuclides in riverbank sediments. It is assumed that there will be continual cycling of radionuclides from the aquatic environment into riverbank sediments taking account of build-up over the 100 year integration period. Dose coefficients for external radiation exposure from surface deposits (Sv/s per Bq/m<sup>2</sup>) from the United States Federal Guidance Report No. 12 [E2] are used in the Committee's revised methodology. However, these dose coefficients apply to an infinite surface (assuming a surface deposit only); for river banks, a geometry factor is applied to allow for the finite size of the source of external exposure. Apostoaei et al. [A2] have discussed appropriate geometry factors (these depend upon the surface area of the sediment on the river bank, as represented by the width of the sediment on the bank, and upon the radionuclide). They recommend that factors for <sup>137</sup>Cs are applicable in general. The Committee agreed to apply a geometry factor of 0.2 based on the values given by Apostoaei et al. for riverbank sediments with a width of a few metres. In addition, the Committee agreed that the methodology should use an annual occupancy factor of 50 hours for the calculation of the characteristic individual dose.

#### (b) *Internal exposure from ingestion*

88. Three sources of internal exposure via ingestion are considered in the methodology: drinking water; freshwater fish and irrigated terrestrial foods. In estimating the characteristic individual doses, it is assumed that only 25% of the food is locally produced (see section II, paragraph 11).

*Drinking water*

89. As described above, the activity concentrations of radionuclides in unfiltered fresh water are assumed to be a function of the volumetric flow rate of the river, which is, in turn, directly related to the type of river assumed. In order to derive activity concentrations in drinking water, element-specific water treatment factors are applied. These are similar to those presented in the UNSCEAR 2000 Report [U6], updated with information included in the most recent edition of the WHO Drinking Water Guidelines [W3]. The WHO provides indicators of the performance of a number of common water-treatment methods for a range of radionuclides.

90. Different treatment techniques are applied across the world and have different effectiveness. Based on information used for the WHO Drinking Water Guidelines [W3], the Committee assumed that—for most countries with high human development indices—flocculation, coagulation, clarification and rapid sand filtration are used. As there are insufficient data available on the techniques employed in less developed countries, the Committee decided to apply a single set of water-treatment factors based on the data for countries with high human development indices. The fractions of each radionuclide removed by standard water-treatment processes assumed in the methodology are shown in table 10.

91. Previously, the Committee used a value of 500 litres per year (1.4 litres per day) [U6, U7, U9] for the worldwide average individual rate of ingestion of drinking water. The Committee has reconfirmed that this value should be retained because it is appropriate for average individual consumption rather than the somewhat higher values typically used for protection purposes.

*Freshwater fish*

92. Individual doses from the ingestion of freshwater fish are calculated using the activity concentrations of radionuclides in fish and the per caput consumption rate; collective doses are calculated using the activity concentrations and fish-catch data. Information on fish-catch data for each region in 2007 was obtained from [F3]. The total fish catch for each region was divided by the size of the population for the same region to derive per caput consumption rates, which were used to estimate characteristic individual doses. Table 13 shows the resulting annual per caput consumption rates of freshwater fish for each region and a world-average value.

Table 13. Annual per caput consumption of freshwater fish by region

These values represent the total intakes of freshwater fish; the factor of 25% to account for local consumption of food is applied subsequently when calculating characteristic individual doses

<i>Region</i>	<i>Annual consumption (kg)</i>
Africa	2.7
Asia and Pacific	7.8
Europe	3.4
Latin America and Caribbean	1.6
North America	4.5
West Asia	1.3
World average	5.7

93. For the calculation of collective doses, the Committee has derived generalized fish-catch information for a range of rivers using data from FAO [F4]. Aquaculture (e.g. the intensive farming of freshwater fish) is excluded from consideration because a large proportion of fish reared in aquaculture come from lakes and ponds [F4].

94. Typical values for the quantity of freshwater fish caught per unit distance and volume of water for typical small and large rivers have been derived for use in the Committee's methodology for each region separately and as a world average. From the FAO data, information was derived on the catch of freshwater fish including and excluding that obtained from aquaculture, plus the annual fish catch for each river in a country. Using information on the length and volume of the relevant stretch of each river, annual fish catches per unit length and per unit volume were calculated and the results are shown in table 14. Based on this information, generic values for small and large rivers were adopted for use in the methodology. It is therefore assumed that one tonne of freshwater fish is caught annually per kilometre from small rivers (of length less than 500 km) and that ten tonnes are caught annually per kilometre from large rivers (length greater than 500 km). Because of the volumes of water assumed for the two river sizes, which also differ by a factor of 10, the freshwater catch per unit volume is independent of river size.

Table 14. Freshwater fish-catch data for a range of rivers

Data taken from FAO [F1] unless otherwise stated

Country	Country-wide annual fish catch		River	Annual fish catch for the river(s)	River		Annual fish catch	
	Including aquaculture (t)	Excluding aquaculture (t)		Excluding aquaculture (t)	Length in specified country (km)	Volume (m <sup>3</sup> )	Per unit volume, excluding aquaculture (t/m <sup>3</sup> )	Per unit length, excluding aquaculture (t/km)
Australia	$4.0 \times 10^3$	$1.2 \times 10^3$	All rivers					$6.2 \times 10^{-1}$
China	$1.9 \times 10^7$	$1.6 \times 10^6$	Pearl	$2.8 \times 10^4$	$1.4 \times 10^3$	$2.3 \times 10^9$	$1.0 \times 10^{-5}$	$2.0 \times 10^1$
Egypt <sup>a</sup>	$9.4 \times 10^5$	$2.3 \times 10^5$	Nile	$2.3 \times 10^5$	$1.5 \times 10^3$			$1.5 \times 10^2$
France	$4.4 \times 10^4$	$2.6 \times 10^3$	Loire	$1.0 \times 10^3$	$5.6 \times 10^2$	$4.3 \times 10^8$	$2.0 \times 10^{-6}$	$1.9 \times 10^0$
			Rhône	$1.5 \times 10^3$	$4.0 \times 10^2$	$6.3 \times 10^8$	$2.0 \times 10^{-6}$	$3.9 \times 10^0$
			All rivers	$2.6 \times 10^3$				$3.0 \times 10^{-1}$
Germany	$5.6 \times 10^4$	$2.1 \times 10^4$	Danube	$7.9 \times 10^3$	$5.0 \times 10^2$	$2.1 \times 10^8$	$4.0 \times 10^{-5}$	$1.6 \times 10^1$
Japan	$6.7 \times 10^4$	$2.5 \times 10^4$	All rivers					$1.4 \times 10^1$
Romania	$1.6 \times 10^4$	$5.7 \times 10^3$	Danube	$5.7 \times 10^3$	$4.0 \times 10^2$	$3.2 \times 10^9$	$2.0 \times 10^{-6}$	$1.4 \times 10^1$
Sudan <sup>b</sup>	$8.1 \times 10^4$	$7.9 \times 10^4$	Nile	$5.4 \times 10^4$				
			Nile tributaries (incl. Blue and White Nile)	$2.5 \times 10^4$				
United Kingdom	$1.6 \times 10^4$	$2.5 \times 10^3$	Thames	$2.3 \times 10^2$	$2.3 \times 10^2$	$2.5 \times 10^7$	$9.0 \times 10^{-6}$	$9.8 \times 10^{-1}$
			Kennet (tributary of Thames)	$6.0 \times 10^0$	$3.3 \times 10^1$	$6.1 \times 10^5$	$9.0 \times 10^{-6}$	$1.7 \times 10^{-1}$
			All rivers	$2.5 \times 10^3$				$8.0 \times 10^{-1}$
United States	$2.5 \times 10^5$	$1.4 \times 10^4$	All rivers					$3.4 \times 10^{-1}$

<sup>a</sup> Additional data obtained from Hamza [H1].<sup>b</sup> Data for 2012 from internal report published by the Sudan Ministry of Animal Resources and Fisheries [S11].

*Irrigated foods*

95. As discussed in section III.B.2(b), the ingestion of irrigated foods is included in the methodology for the estimation of both characteristic individual and collective doses. In the calculation of individual doses from this pathway, it is assumed that cereals and vegetables are irrigated. For the assessment of collective doses, it is assumed that only cereals are irrigated, because these represent the bulk of irrigated crops intended for human consumption [F4].

96. As illustrated in table 15 [C1], there are variations in irrigation rate which are likely to depend to some extent upon factors such as the type of crop and the climate. A single value for a daily irrigation rate was considered to be appropriate for the purposes of this methodology. The United States NCRP in its screening methodology uses a value of 5 L/m<sup>2</sup> for the volume of irrigation water applied per unit area for a period of 150 days annually[N2]. The FAO AQUASTAT database [F4] contains data for a wide range of countries on irrigation water withdrawals and/or requirements, and on the total areas of irrigated crops harvested. These data could then be used to indicate values of daily irrigation rates in L/m<sup>2</sup> assuming a total irrigation period of 150 days in a year. Table 16 illustrates the range of irrigation rates thus obtained from the FAO data. The irrigation rate varies from country to country and although some of the highest values are for arid areas of the world, some countries that are generally arid (e.g. Peru) do not have particularly high estimated irrigation rates. From the data in tables 15 and 16 a single value for the daily irrigation rate of 4 L/m<sup>2</sup> was adopted for the methodology.

Table 15. Irrigation rates averaged over the growing season for various crops and climates [C1]

Country or area	Crop type	Daily irrigation rate (L/m <sup>2</sup> )			Reference
		Min	Average	Max	
Canada	Forage		0		[C6]
	Garden vegetables	0		1.8	
France (Loire Valley)	Fruit	2		6	[C4]
	Garden vegetables	2		6	
	Grain	0		2.4	
	Maize	0.8		2.8	
India	Banana		2.6		[P1]
	Gram		1.8		
	Ground nut		6.3		
	Improved jowar		2.0		
	Pigeon pea		1.6		
	Rice		0.9		
	Sugar cane		4.1		
	Turmeric		2.1		
	Wheat		4.3		
Republic of Korea	Rice	5		8	[J4]

Country or area	Crop type	Daily irrigation rate (L/m <sup>2</sup> )			Reference
		Min	Average	Max	
United States (California)	Alfalfa	4.9		7.1	[U14]
	Barley	2.4		3.2	
	Fruit orchards	3.9		4.9	
	Garden vegetables	4.2		5.2	
	Hay	3.2		5.4	
	Oats, rye	2.0		2.5	
	Pasture	3.7		4.4	
	Grapes		1.7		[B5]

Table 16. Effective irrigation rates obtained from data in the FAO AQUASTAT database [F4]

Country	Daily irrigation rate (L/m <sup>2</sup> )
Algeria	5.2
Argentina	3.5
Australia	3.3
Bangladesh	2.8
Brazil	1.9
Canada	4.1
China	1.8
Egypt	5
France	1.4
Greece	2.8
India	2.8
Indonesia	2.3
Japan	8.6
Kenya	3.2
Peru	3.5
Qatar	7.3
Russian Federation	6.5
Spain	4.5
United States	5.1

97. Collective doses from irrigation are determined by assuming that, on average, the fraction of water abstracted for irrigation from the type of river of interest, in a given geographical region, is the same as the fraction of water abstracted for irrigation purposes from all surface waters (rivers, lakes and so on). The fraction of water abstracted for irrigation and the amount of land irrigated per unit volume of water, was derived from information in the FAO AQUASTAT database [F4]. This information, together with the annual yields of cereals [F1] (given in table 17), the integrated activity concentrations of radionuclides in cereals for unit deposition rate (given in table 5), and the percentage of irrigation

that is sprinkler irrigation (see table 12 and section III.B.2(b)), is used to calculate collective doses from irrigation. Table 17 shows the parameter values used in the methodology for the estimation of collective doses in different regions from the irrigation of cereals; world-average values are also given.

Table 17. Parameter values used in the model for the irrigation of cereals

<i>Region</i>	<i>Annual cereal yield (kg/m<sup>2</sup>)<sup>a</sup></i>	<i>Fraction of surface water used for irrigation<sup>b</sup> <math>F_{\text{irr,surface}}</math></i>	<i>Area irrigated per unit volume of water withdrawn<sup>b</sup> <math>A_{\text{irr,unit}}</math> (m<sup>2</sup> a/m<sup>3</sup>)</i>
Africa	$2.3 \times 10^{-1}$	$2.7 \times 10^{-2}$	$6.0 \times 10^{-1}$
Asia and Pacific	$2.9 \times 10^{-1}$	$9.4 \times 10^{-2}$	$7.9 \times 10^{-1}$
Europe	$3.6 \times 10^{-1}$	$1.2 \times 10^{-2}$	$1.9 \times 10^0$
Latin America and Caribbean	$3.3 \times 10^{-1}$	$1.0 \times 10^{-2}$	$8.2 \times 10^{-1}$
North America	$3.0 \times 10^{-1}$	$2.4 \times 10^{-2}$	$1.3 \times 10^0$
West Asia	$2.9 \times 10^{-1}$	$5.7 \times 10^{-1}$	$4.7 \times 10^{-1}$
World average	$3.0 \times 10^{-1}$	$3.9 \times 10^{-2}$	$8.5 \times 10^{-1}$

<sup>a</sup> From FAO 2010 [F1].

<sup>b</sup> From FAO 2014a [F3].

#### 4. Individual and collective doses

98. Annual characteristic individual doses arising from the ingestion of drinking water and freshwater fish are calculated using the derived activity concentrations of radionuclides in water and fish, the relevant consumption rates, and the dose coefficients for ingestion (see table 1). Because the activity concentrations in unfiltered fresh water are assumed to be a function of the river flow rate alone, these individual dose estimates are directly related to the type of river assumed.

99. Collective doses are calculated using the total abstraction rate of drinking water and the total catch of fish associated with the freshwater body. The abstraction rate of drinking water is assumed to be a fraction of that abstracted for municipal use. The abstraction rate was derived from FAO statistics which indicate that around 1–10% of domestic water is used for drinking [F1]. Since not all municipal water will be for domestic use, the lower end of this range is applied in this methodology. The total amount of water abstracted depends on the size of the water body with smaller amounts removed from small rivers than from large rivers; the water flow is also inversely related to this size. This means that, although for small rivers the activity concentrations per unit discharge are higher than for large rivers, the amount of water abstracted is lower and therefore—using the Committee’s methodology—the collective doses from drinking water are estimated to be essentially independent of river size.

100. The irrigation pathway is considered using generic irrigation rates and transfer factors appropriate for a terrestrial environment. Characteristic individual doses from this pathway are determined using region-specific population-weighted consumption rates and the assumption that 25% of the food is locally produced. Collective doses are determined from information on the region-specific proportion of water abstracted from surface waters for irrigation purposes, the area irrigated and the annual yield of cereal products.

101. Collective doses from the consumption of water and freshwater fish are calculated on the basis of the total abstraction of water and fish-catch data, respectively, and are thus related to the river as a whole and cannot be divided into local and regional components.

### C. Assessment of doses from discharges to a marine environment

102. As indicated above, the Committee decided to develop generic dose calculation factors that take account of dispersion within different types of water bodies. The approach used for assessing doses from discharges into a marine environment is based on a simple two-box compartment model, the characteristics of which are broadly representative of areas where discharges into a coastal environment occur (see figure IV, which is based on [C2]). The larger compartment (referred to as the regional box) could also be used to assess the dispersion of radionuclides discharged into the deep sea from oil and gas platforms, if required.

103. The following exposure pathways are considered for discharges to a marine environment (see figure I):

- (a) External exposure from radionuclides (beta and gamma emitters) in sediments;
- (b) Internal exposure from ingestion of radionuclides incorporated into marine foods.

The first pathway is considered for the calculation of characteristic individual doses only; a review of previous studies assessing collective dose indicated that this pathway provided less than 1% of the collective dose. Similar to discharges to atmosphere and freshwater environments, other exposure pathways (e.g. inadvertent ingestion of water or sediments, and exposures during swimming) are possible; however, the ingestion of marine foods has been found to be the most important exposure pathway in published assessments of collective doses (for example, see [J5]).

Figure IV. Simple two-box compartment model representing a marine environment

$Q$  is the discharge rate (Bq/a);  $\lambda_{l,r}$  is the effective rate of transfer between the local and regional compartments ( $a^{-1}$ ), taking into account exchange between the compartments;  $\lambda_{r,g}$  is the effective rate of transfer between the regional and global oceans ( $a^{-1}$ ), taking into account exchange between the compartments;  $\lambda_{s,l}$  and  $\lambda_{s,r}$  are the rates of transfer to sediment for the local and regional compartments, respectively ( $a^{-1}$ ), and  $\lambda_i$  is the radioactive decay constant for radionuclide,  $i$ , ( $a^{-1}$ )

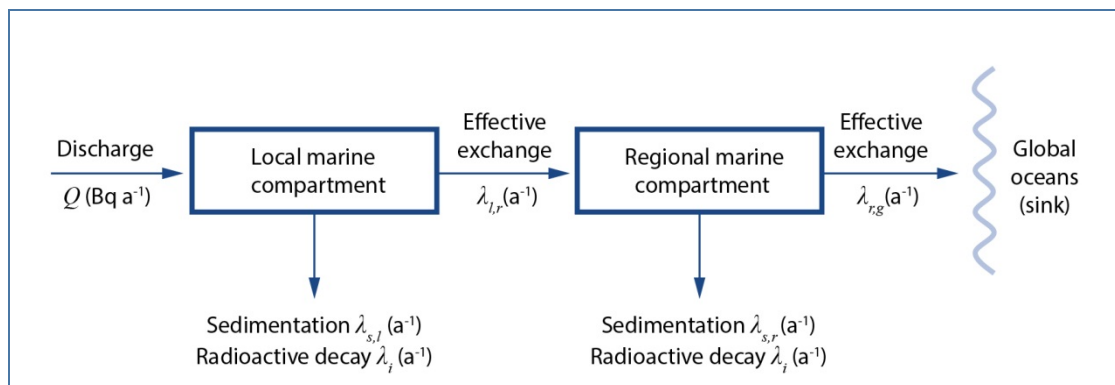



104. Figure IV illustrates the simplified approach used to model the movements of radionuclides between marine compartments. The model considers inputs (such as discharges and incoming transfers of radionuclides) and losses (such as radioactive decay, sedimentation and outgoing transfers of radionuclides). This allows the activity concentrations in the local and regional compartments to be determined. The equations and parameter values associated with this approach are presented in the appendix. The model includes transfer to other marine areas but any contribution to collective doses from the global oceans is only considered for the long-lived radionuclides ( $^3\text{H}$ ,  $^{14}\text{C}$  and  $^{129}\text{I}$ ) in a separate global circulation model as discussed below. The size of the regional compartment and the related transfer parameters have been chosen to ensure that the model is a reasonable representation. A comparison with a more complex multi-compartmental marine model [S7, S8], which has been validated against measurement data, has shown that the simple model is adequate for the purpose of this methodology.

105. The dimensions and characteristics applied in the methodology are presented in table 18.

Table 18. Characteristics of the marine compartment model

Characteristic	Marine compartment	
	Local	Regional
Volume ( $\text{m}^3$ )	$1 \times 10^9$	$1 \times 10^{15}$
Effective rate of transfer between compartments ( $\text{a}^{-1}$ ):		
Local to regional, $\lambda_{l,r}$	$2 \times 10^1$	
Regional to global, $\lambda_{r,g}$		1
Depth (m)	10	1 000
Suspended sediment load, SSL ( $\text{t}/\text{m}^3$ )	$2 \times 10^{-4}$	$1 \times 10^{-7}$
Sedimentation rate, SR ( $\text{t m}^{-2} \text{a}^{-1}$ )	$1 \times 10^{-4}$	$1 \times 10^{-5}$
Length of coastline (km)	10	1 000
OTHER PARAMETERS		
Volume of global oceans, $V_g$ ( $\text{m}^3$ )	$1 \times 10^{18}$	
Volumetric exchange between local and regional compartments, $\Delta V_{l,r}$ ( $\text{m}^3/\text{a}$ )	$2 \times 10^{10}$	
Volumetric exchange between regional compartment and global oceans, $\Delta V_{r,g}$ ( $\text{m}^3/\text{a}$ )	$1 \times 10^{15}$	

106. The transfer of radionuclides between water and sediments is dependent on a combination of factors that relate to the characteristics of the water body and of individual radionuclides. The key radionuclide-independent parameters are the suspended sediment load and sedimentation rate, which are determined by the nature of the coastal or marine compartment. Values have been chosen from the range of those associated with European waters [S7]. Sedimentation is also dependent upon the radionuclide-dependent partition factor ( $K_d$ ) for a coastal or marine environment; these values have been derived from [I3].

107. The purpose of the local marine compartment is to allow doses to a characteristic individual living in the area and collective doses to the local population to be calculated. The selected dimensions of the local marine compartment allow tidal, bathymetric and sedimentary conditions to be broadly homogenous throughout the compartment and have been selected so that the compartment is sufficiently large to represent a source of shellfish for the local population. The dimensions of the local

marine compartment are typical of those used in the MARINA II project for European waters [S7]. The dimensions of the regional marine compartment are significantly larger than those generally adopted for site-specific modelling: approximately equivalent to the size of the north-east Atlantic. This again reflects the purpose of the methodology; the regional marine compartment is intended to represent the source of exposure for the regional component of collective dose, which is assumed to extend for a distance of around 1,500 km from the point of discharge.

108. The depth of the sea in the regional marine compartment is assumed to be 1,000 m, which is the depth down to which fish are assumed to be caught.

109. The sensitivity of the calculated activity concentrations of radionuclides in water to changes in the volume of the local compartment and movements between the local and regional compartments was investigated. The calculated activity concentrations in water in the local compartment (assuming constant transfer rates between the local and regional compartments) decrease proportionally as the volume of the local compartment increases. A water transfer rate of 20–40 a<sup>-1</sup> is typical of those found in European waters based on the volume exchange rates and water volumes given in [S8]. The Committee adopted a volume of 1 × 10<sup>9</sup> m<sup>3</sup> with a water transfer rate of 20 a<sup>-1</sup> for the local marine compartment as being reasonably representative of coastal conditions into which nuclear sites are known to discharge.

110. The values of the sedimentation rate and suspended sediment load adopted for the local compartment are typical of values for local compartments around the United Kingdom (e.g. the south-western part of the North Sea) [S7]. The values adopted for the regional compartment correspond to the north-east Atlantic [S7], considered to be typical of large deep oceans.

## 1. Radionuclide transfers in a marine environment

111. The key element-specific parameters that take account of the transfer of radionuclides from water to other parts of a marine environment are (a) concentration factors, which relate concentrations of elements in fish and shellfish to their concentrations in water, and (b) partition coefficients, which express the distribution of elements between sediment and water. The most significant international compilation of concentration factors (also referred to as bioaccumulation factors) and partition coefficients,  $K_d$ , for coastal and deep-sea environments is presented in [I3]. Following a critical review of the data, these values have been adopted and applied in the present methodology, and are given in table 19.

Table 19. Radionuclide-specific parameters used in the marine model

Radio-nuclide	Concentration factor (L/kg) (fresh weight)			Dose coefficient for external exposure from surface deposit <sup>a</sup> , $D_{\text{ex,deposit}}$ (Sv/s per Bq/m <sup>2</sup> ) [E2]	Partition coefficient (L/kg) (dry weight sediment)	
	Fish $B_{\text{fish}}$ [I3]	Crustaceans $B_{\text{crust}}$ [I3]	Molluscs $B_{\text{molluscs}}$ [I3]		Ocean margin $K_{d,\text{local}}$ [I3]	Open ocean $K_{d,\text{regional}}$ [I3]
<sup>3</sup> H	1 × 10 <sup>0</sup>	1 × 10 <sup>0</sup>	1 × 10 <sup>0</sup>	0	1 × 10 <sup>0</sup>	1 × 10 <sup>0</sup>
<sup>14</sup> C	2 × 10 <sup>4</sup>	2 × 10 <sup>4</sup>	2 × 10 <sup>4</sup>	1.3 × 10 <sup>-20</sup>	1 × 10 <sup>3</sup>	2 × 10 <sup>3</sup>
<sup>35</sup> S	1 × 10 <sup>0</sup>	1 × 10 <sup>0</sup>	3 × 10 <sup>0</sup>	1.3 × 10 <sup>-20</sup>	5 × 10 <sup>-1</sup>	1 × 10 <sup>0</sup>
<sup>54</sup> Mn	1 × 10 <sup>3</sup>	5 × 10 <sup>3</sup>	5 × 10 <sup>4</sup>	7.9 × 10 <sup>-16</sup>	2 × 10 <sup>6</sup>	2 × 10 <sup>8</sup>
<sup>58</sup> Co	7 × 10 <sup>2</sup>	7 × 10 <sup>3</sup>	2 × 10 <sup>4</sup>	9.3 × 10 <sup>-16</sup>	3 × 10 <sup>5</sup>	5 × 10 <sup>7</sup>
<sup>60</sup> Co	7 × 10 <sup>2</sup>	7 × 10 <sup>3</sup>	2 × 10 <sup>4</sup>	2.3 × 10 <sup>-15</sup>	3 × 10 <sup>5</sup>	5 × 10 <sup>7</sup>
<sup>65</sup> Zn	1 × 10 <sup>3</sup>	3 × 10 <sup>5</sup>	8 × 10 <sup>4</sup>	5.4 × 10 <sup>-16</sup>	7 × 10 <sup>4</sup>	2 × 10 <sup>5</sup>
<sup>90</sup> Sr+ <sup>90</sup> Y	3 × 10 <sup>0</sup>	5 × 10 <sup>0</sup>	1 × 10 <sup>1</sup>	1.6 × 10 <sup>-18</sup>	8 × 10 <sup>0</sup>	2 × 10 <sup>2</sup>
<sup>106</sup> Ru + <sup>106</sup> Rh	2 × 10 <sup>0</sup>	1 × 10 <sup>2</sup>	5 × 10 <sup>2</sup>	3.5 × 10 <sup>-16</sup>	4 × 10 <sup>4</sup>	1 × 10 <sup>3</sup>
<sup>129</sup> I	9 × 10 <sup>0</sup>	3 × 10 <sup>0</sup>	1 × 10 <sup>1</sup>	2.0 × 10 <sup>-17</sup>	7 × 10 <sup>1</sup>	2 × 10 <sup>2</sup>
<sup>131</sup> I	9 × 10 <sup>0</sup>	3 × 10 <sup>0</sup>	1 × 10 <sup>1</sup>	3.6 × 10 <sup>-16</sup>	7 × 10 <sup>1</sup>	2 × 10 <sup>2</sup>
<sup>134</sup> Cs	1 × 10 <sup>2</sup>	5 × 10 <sup>1</sup>	6 × 10 <sup>1</sup>	1.5 × 10 <sup>-15</sup>	4 × 10 <sup>3</sup>	2 × 10 <sup>3</sup>
<sup>137</sup> Cs+ <sup>137m</sup> Ba	1 × 10 <sup>2</sup>	5 × 10 <sup>1</sup>	6 × 10 <sup>1</sup>	5.8 × 10 <sup>-16</sup>	4 × 10 <sup>3</sup>	2 × 10 <sup>3</sup>
<sup>210</sup> Pb	2 × 10 <sup>2</sup>	9 × 10 <sup>4</sup>	5 × 10 <sup>4</sup>	2.1 × 10 <sup>-18</sup>	1 × 10 <sup>5</sup>	1 × 10 <sup>7</sup>
<sup>212</sup> Pb	2 × 10 <sup>2</sup>	9 × 10 <sup>4</sup>	5 × 10 <sup>4</sup>	1.4 × 10 <sup>-16</sup>	1 × 10 <sup>5</sup>	1 × 10 <sup>7</sup>
<sup>214</sup> Pb	2 × 10 <sup>2</sup>	9 × 10 <sup>4</sup>	5 × 10 <sup>4</sup>	2.4 × 10 <sup>-16</sup>	1 × 10 <sup>5</sup>	1 × 10 <sup>7</sup>
<sup>210</sup> Po	2 × 10 <sup>3</sup>	2 × 10 <sup>4</sup>	2 × 10 <sup>4</sup>	8.1 × 10 <sup>-21</sup>	2 × 10 <sup>7</sup>	2 × 10 <sup>7</sup>
<sup>226</sup> Ra	1 × 10 <sup>2</sup>	1 × 10 <sup>2</sup>	1 × 10 <sup>2</sup>	6.1 × 10 <sup>-18</sup>	2 × 10 <sup>3</sup>	4 × 10 <sup>3</sup>
<sup>228</sup> Ra	1 × 10 <sup>2</sup>	1 × 10 <sup>2</sup>	1 × 10 <sup>2</sup>	0	2 × 10 <sup>3</sup>	4 × 10 <sup>3</sup>
<sup>228</sup> Th	6 × 10 <sup>2</sup>	1 × 10 <sup>3</sup>	1 × 10 <sup>3</sup>	2.1 × 10 <sup>-18</sup>	3 × 10 <sup>6</sup>	5 × 10 <sup>6</sup>
<sup>230</sup> Th	6 × 10 <sup>2</sup>	1 × 10 <sup>3</sup>	1 × 10 <sup>3</sup>	6.4 × 10 <sup>-19</sup>	3 × 10 <sup>6</sup>	5 × 10 <sup>6</sup>
<sup>232</sup> Th	6 × 10 <sup>2</sup>	1 × 10 <sup>3</sup>	1 × 10 <sup>3</sup>	4.6 × 10 <sup>-19</sup>	3 × 10 <sup>6</sup>	5 × 10 <sup>6</sup>
<sup>234</sup> Th	6 × 10 <sup>2</sup>	1 × 10 <sup>3</sup>	1 × 10 <sup>3</sup>	7.5 × 10 <sup>-18</sup>	3 × 10 <sup>6</sup>	5 × 10 <sup>6</sup>
<sup>234</sup> U	1 × 10 <sup>0</sup>	1 × 10 <sup>1</sup>	3 × 10 <sup>1</sup>	5.9 × 10 <sup>-19</sup>	1 × 10 <sup>3</sup>	5 × 10 <sup>2</sup>
<sup>238</sup> U	1 × 10 <sup>0</sup>	1 × 10 <sup>1</sup>	3 × 10 <sup>1</sup>	4.2 × 10 <sup>-19</sup>	1 × 10 <sup>3</sup>	5 × 10 <sup>2</sup>
<sup>239</sup> Pu	1 × 10 <sup>2</sup>	2 × 10 <sup>2</sup>	3 × 10 <sup>3</sup>	2.8 × 10 <sup>-19</sup>	1 × 10 <sup>5</sup>	1 × 10 <sup>5</sup>
<sup>240</sup> Pu	1 × 10 <sup>2</sup>	2 × 10 <sup>2</sup>	3 × 10 <sup>3</sup>	6.0 × 10 <sup>-19</sup>	1 × 10 <sup>5</sup>	1 × 10 <sup>5</sup>
<sup>241</sup> Am	1 × 10 <sup>2</sup>	4 × 10 <sup>2</sup>	1 × 10 <sup>3</sup>	2.3 × 10 <sup>-17</sup>	2 × 10 <sup>6</sup>	2 × 10 <sup>6</sup>

<sup>a</sup> These dose coefficients are for the parent only; the contribution from short-lived progeny is added separately (see appendix).

## 2. External and internal exposure

### (a) External exposure from radionuclides in beach sediments

112. Annual characteristic individual doses due to external exposure from occupancy of beaches are estimated on the basis of the modelled activity concentrations of each radionuclide in sediments, the relevant dose coefficients for external exposure from surface deposits and the amount of time spent on the beach.

113. The activity concentration of each radionuclide in sediments is estimated using the activity concentration in water, the relevant partition coefficient  $K_d$ , an assumed average thickness of sediment of 5 cm and an assumed density of sediment of  $1.2 \text{ t/m}^3$  [I2]. The dose coefficients for external exposure from surface deposits are taken from [E2] for each radionuclide. A factor of 0.5 is applied to the dose coefficients to account for the geometry of the radionuclide distribution on a marine shoreline [E2]. The estimates of effective dose include contributions from beta and gamma irradiation of the skin from radionuclides in the sediment. Any additional dose from irradiation of the skin due to direct contact with sediment is not included in the methodology because it is deemed not a major contributor to the overall characteristic individual doses.

114. An average individual beach occupancy rate of around four days per year is assumed, based on data for the Nord-Cotentin area of France [R1]. Because this exposure pathway is unlikely to be a significant contributor to collective doses from nuclear installations [J6], it is not included in the estimation of collective dose.

### (b) Ingestion of marine foods

115. Annual individual doses from ingestion of radionuclides in marine foods are estimated from the modelled activity concentration of each radionuclide in fish and shellfish (comprising crustaceans and molluscs) harvested from the relevant marine compartment, the region-specific or world-average annual consumption of the food (for adults) and the relevant dose coefficient for ingestion of each radionuclide. Information on the annual consumption of marine fish, crustaceans and molluscs was obtained from WHO [W2] and the values used are given in table 20.

Table 20. Per caput annual consumption of marine foods by region

Based on data provided by WHO [W2]

Region	Per caput annual consumption of food (kg)		
	Fish	Crustaceans	Molluscs
Africa	6.6	0.1	0 <sup>a</sup>
Asia and Pacific	6.9	1.4	2.4
Europe	13	0.9	1.0
Latin America and Caribbean	5.9	0.6	0.4
North America	8.2	2.8	1.4
West Asia	4.5	0.3	0 <sup>a</sup>
World average	7.5	1.1	1.6

<sup>a</sup> Consumption rate is less than  $2 \times 10^{-2} \text{ kg/a}$  and treated as 0.

116. Activity concentrations of radionuclides in aquatic foods are estimated from the product of the modelled activity concentrations in water and concentration factors that relate the activity concentrations in sea food to those in water (see table 19). In order to apply this approach, it was necessary to make some assumptions about the origin of the food and therefore the activity concentrations in water that are appropriate to adopt. Thus, it was necessary to make an assumption about the proportions of fish and shellfish that are derived from each compartment in the model.

117. One approach applied to estimate doses to individuals is to assume that a certain proportion of fish and shellfish is derived from the local and regional marine compartments. The proportions assumed would depend upon the purpose of the assessment. In a similar manner to that used for terrestrial and freshwater foods, it is assumed in the Committee's methodology that the characteristic individual obtains 25% of their fish consumption from the local compartment, with the remaining fraction obtained from the regional compartment. All of the crustaceans and molluscs are assumed to be obtained from the local compartment.

118. The respective local and regional components of collective dose from marine discharges are estimated using (a) data on the average crustacean-catch and mollusc-catch per unit length of coastline appropriate for the local compartment, and (b) data on the average fish-catch per unit volume appropriate for the regional compartment. Catch data for fish, crustaceans and molluscs were derived from the FAO FishStatJ software [F2], which comprises the FAO databases on capture and aquaculture for major fishing areas from 1955 to 2012. The area of sea and length of coastline associated with each of the major fishing areas were determined using a geographical information system (ArcGIS, version 10) and then used to estimate the relevant values for the UNEP geographical regions employed in the methodology; world-average values were also derived. The edible fraction of the catch of fish, crustaceans and molluscs is assumed to be 0.5, 0.35 and 0.15, respectively [S6]. Table 21 shows the catch data for estimating collective doses for the different regions.

Table 21. Annual catch of fish, crustaceans and molluscs used for estimating collective doses from discharges to marine environments [F2]

Region	Annual catch		
	Mass of fish per unit area of sea (kg/km <sup>2</sup> )	Mass of crustaceans per unit length of coastline (kg/km)	Mass of molluscs per unit length of coastline (kg/km)
Africa	$2 \times 10^2$	$4 \times 10^3$	$5 \times 10^3$
Asia and Pacific	$2 \times 10^2$	$1 \times 10^4$	$5 \times 10^4$
Europe	$2 \times 10^2$	$1 \times 10^3$	$5 \times 10^3$
Latin America and Caribbean	$9 \times 10^1$	$7 \times 10^3$	$1 \times 10^4$
North America	$6 \times 10^1$	$7 \times 10^3$	$7 \times 10^3$
West Asia	$2 \times 10^2$	$5 \times 10^3$	$5 \times 10^3$
World average	$1 \times 10^2$	$8 \times 10^3$	$3 \times 10^4$

### (c) *Individual and collective doses*

119. Annual individual doses arising from the ingestion of marine fish and shellfish are estimated using the modelled activity concentrations of radionuclides in water and fish, the per caput annual consumptions given in table 20 and the dose coefficients for ingestion of the relevant radionuclides given in table 1.

120. To estimate collective doses, region-specific information on the catch of fish and shellfish per unit area of sea or length of coastline are applied from table 21.

## IV. GLOBALLY DISPERSED RADIONUCLIDES

121. The Committee has periodically assessed public exposure to long-lived globally dispersed radionuclides discharged from nuclear power and reprocessing plants since 1982. The radionuclides of particular interest are  $^3\text{H}$ ,  $^{14}\text{C}$ ,  $^{85}\text{Kr}$  and  $^{129}\text{I}$ . The features of the approaches used and the evolution of the Committee's approach are summarized in electronic attachment 2. The estimated collective doses per unit discharge integrated to various times after discharge are summarized in table 22 at the end of this section.

### A. Tritium

122. The Committee's previous approach to estimating the doses from the global circulation of tritium discharged from nuclear installations [U6] was based on a comparison of models developed by Kelly et al. [K2], NCRP [N1], Bergman et al. [B2] and Killough and Kocher [K4]. The relevant concentration of tritium for each compartment of the Committee's model was determined from the total amount of tritium in the compartment divided by the volume of water represented in the compartment. The concentration in humans was then estimated from the modelled concentration of tritium and the relevant fractional intake from each compartment of the model.

123. The global collective dose from discharges to the near-surface atmosphere within the 30°–50° latitude band of the northern hemisphere was estimated by the Committee using the model developed by Killough and Kocher [K4]. This gave a global collective dose per unit discharge of tritium of 2.3 man Sv/PBq [U6]. The global collective dose arising from discharges to the ocean estimated by NCRP [N1] and Bergman et al. [B2] was around one tenth of that arising from discharges to atmosphere. A value of 0.2 man Sv/PBq was therefore adopted in the UNSCEAR 2000 Report [U6] for the collective dose per unit discharge of tritium to the ocean. The Committee still considers these estimates to be appropriate for a world population of 10 billion.

124. The approach used by the Committee to estimate the collective dose commitment is summarized as follows [S8]:

$$S(t) = \sum_c \sum_p I_c(t) \cdot f_{p,c} \cdot R_c \cdot U_p \cdot P \quad (15)$$

where  $S(t)$  is the collective dose commitment truncated at time  $t$  (man Sv);  $I_c(t)$  is the time-integrated activity concentration in compartment  $c$  at time  $t$  ((Bq a)/kg);  $f_{p,c}$  is the fraction of the individual's intake of water due to pathway  $p$ ;  $R_c$  is the total consumption rate by an individual of water from compartment  $c$  (kg/a);  $U_p$  is the dose per unit intake from pathway  $p$  (Sv/Bq); and  $P$  is the number of people in the exposed population. This model was implemented in the PC-CREAM 08 computer system [S8] and has been used to derive values for the global collective doses from unit discharges of tritium for the Committee's methodology. An important factor in the collective dose estimation is the assumed number of people in the world population. The estimate of the United Nations for this for 1 December 2014 was 6.4 billion ( $6.4 \times 10^9$ ) [U2]. The value for the global population of 10 billion used in the Committee's methodology is equivalent to the United Nations' median estimate of the projected population for 2060 [U1] and is deemed reasonable as a rounded value for collective doses integrated into the future.

## B. Carbon-14

125. Carbon-14 is the largest contributor to the collective dose from global dispersion of long-lived radionuclides discharged from reprocessing of nuclear fuel and is a significant contributor to that resulting from operation of nuclear reactors. A 23-compartment model [T1] (see figure VI, annex A of the UNSCEAR 2000 Report [U6]) was applied by the Committee to estimate the activity per unit mass of carbon in each environmental compartment over time. Once mixing had been achieved, a specific-activity approach was used to estimate the collective dose commitments from  $^{14}\text{C}$ , assuming that the specific activity of  $^{14}\text{C}$  in the carbon ingested by humans was the same as that in the compartments that directly related to the intake of food (i.e. ground vegetation for terrestrial foods and surface water compartments for marine foods). The collective dose commitment per unit discharge to atmosphere, truncated at 10,000 years, was estimated to be 109,000 man Sv/PBq. The model can be used to estimate collective doses for discharges to any compartment; the collective doses from unit discharge to the surface waters of oceans were found to be about the same as those from unit discharges to atmosphere, but doses from unit discharges to deep oceans were around 20% lower [U6]. Killough and Rohwer [K3] found that the estimates from six models differed by a factor of only 1.5, suggesting a remarkable level of agreement (although it has not been possible to fully validate any of the models against global measurements). This has been attributed to the long half-life of  $^{14}\text{C}$  relative to its rate of movement in the environment, which makes calculated dose commitments insensitive to the detailed structure of the models [K3].

126. The Committee has therefore not modified its approach to the estimation of collective dose commitment from  $^{14}\text{C}$  from that used in 2000. The approach to derive the collective dose commitment is implemented in PC-CREAM 08 and is summarized as follows [S8]:

$$S(t) = \sum_c \sum_p I_c(t) \cdot f_{p,c} \cdot R_c \cdot U_p \cdot P \quad (16)$$

where  $S(t)$  is the collective dose commitment truncated at time  $t$  (man Sv);  $I_c(t)$  is the time-integrated activity concentration in compartment  $c$  at time  $t$  (Bq a/kg);  $f_{p,c}$  is the fraction of the individual's intake of carbon from pathway  $p$ ;  $R_c$  is the total intake rate of stable carbon (kg/a);  $U_p$  is the dose per unit intake from pathway  $p$  (Sv/Bq); and  $P$  is the size of the exposed population. As before for tritium, the world population is assumed to be 10 billion.

## C. Iodine-129

127. The Committee used the global circulation compartment model for  $^{129}\text{I}$  developed by Titley et al. [T1] for the assessment it presented in the UNSCEAR 2000 Report (see figure VII, annex A [U6]). The inventories of stable iodine in the compartments of the model and the transfers between the compartments were estimated from environmental measurements and the requirement that the total mass of iodine in the environment was balanced. Iodine intakes by humans from each model compartment were estimated from the average inhalation and food consumption rates combined with the concentrations of stable iodine in the atmosphere and foods respectively, or using a specific-activity approach. Five exposure pathways were considered as follows, with the values of individual intakes of stable iodine used given in brackets: inhalation (0.29  $\mu\text{g}/\text{d}$ ); deposition from the atmosphere onto crops followed by ingestion by humans or by dairy or beef cattle subsequently ingested by humans (6.6  $\mu\text{g}/\text{d}$ ); ingestion of surface water (5.3  $\mu\text{g}/\text{d}$ ); ingestion of marine fish and shellfish (11  $\mu\text{g}/\text{d}$ ); and root uptake from soils and surface waters followed by ingestion of crops and animal products (200  $\mu\text{g}/\text{d}$ ).

128. The PC-CREAM computer code [S8] also implements the model by Titley et al. The approach used to estimate the collective dose is similar to that used for tritium and  $^{14}\text{C}$ , except that individual intakes were estimated using transfer factors to relate the activity concentrations in food and air to the activity concentrations in the various compartments, rather than to the intake of stable iodine. The Committee still considers this approach to be appropriate.

## D. Krypton-85

129. The Committee's approach to estimating the global dispersion of  $^{85}\text{Kr}$  is described in detail in the UNSCEAR 1988 Report [U5]. It was based on the approach presented in the UNSCEAR 1982 Report [U4], where a simple two-compartment model was used for the discharge of  $^{85}\text{Kr}$  [C2]. The two compartments represent the tropospheres of the northern and southern hemispheres. A transfer coefficient of  $0.5 \text{ a}^{-1}$  between the compartments was used. The time-integrated activity concentration in air per unit discharge was  $10^{-10} (\text{Bq s})/\text{m}^3$  per Bq [U4]. The dose coefficients to convert from activity concentration in air to absorbed dose rate in air and absorbed dose rate in skin from the emitted beta radiation were derived from [C2].

130. The value of the collective effective dose equivalent per unit discharge used in the UNSCEAR 1982 Report [U4] was 0.17 man Sv/PBq (based on a world population in 1982 of 4 billion). This was scaled to 0.2 man Sv/PBq for an assumed population in 1988 of 4.6 billion [U5]. It was noted that this collective dose commitment would be delivered during the first 50 years after discharge.

131. No changes have been made to the previous approach to modelling the dispersion of  $^{85}\text{Kr}$ . Around 50% of the effective dose arises from gamma irradiation of the whole body, and 50% arises from beta irradiation of the skin [I8, Z1]. The value of dose rate for unit activity per mass of air is  $8 \times 10^{-9} \text{ Sv/a}$  per Bq/kg (the value is given per unit mass of air because this expression is required for the global circulation model and was obtained using a density of air of  $1.225 \text{ kg}/\text{m}^3$ ), based on an assumption of immersion in a semi-infinite cloud (with no shielding) [S8]. The collective dose commitment is then estimated as follows:

$$S(t) = I(t) \cdot F \cdot P \quad (17)$$



where  $S(t)$  is the collective dose commitment truncated at time  $t$  (man Sv);  $I(t)$  is the time-integrated activity concentration in air of the appropriate hemisphere at time  $t$  ((Bq a)/kg);  $F$  is the dose rate per unit concentration in air (Sv/a per Bq/kg); and  $P$  is the number of people in the exposed population. As for the other globally circulating radionuclides, the Committee has taken for its methodology values of collective doses derived by PC-CREAM 08, which implements the model used by the Committee and uses a world population of 10 billion.

Table 22. Collective dose commitments from globally dispersed radionuclides

Radionuclide	Collective dose commitment truncated after a given time from a radionuclide discharge of 1 Bq/s over a year (man Sv)					
	To atmosphere			To a marine environment		
	100 years	500 years	10 000 years	100 years	500 years	10 000 years
$^3\text{H}$	$1.0 \times 10^{-8}$	$1.0 \times 10^{-8}$	$1.0 \times 10^{-8}$	$1.1 \times 10^{-9}$	$1.1 \times 10^{-9}$	$1.1 \times 10^{-9}$
$^{14}\text{C}$	$2.8 \times 10^{-4}$	$5.6 \times 10^{-4}$	$2.7 \times 10^{-3}$	$1.1 \times 10^{-4}$	$3.5 \times 10^{-4}$	$2.5 \times 10^{-3}$
$^{85}\text{Kr}$	$8.0 \times 10^{-9}$	$8.0 \times 10^{-9}$	$8.0 \times 10^{-9}$	—	—	—
$^{129}\text{I}$	$2.7 \times 10^{-3}$	$3.1 \times 10^{-3}$	$7.4 \times 10^{-3}$	$3.3 \times 10^{-6}$	$6.7 \times 10^{-6}$	$1.4 \times 10^{-4}$

## V. LIMITATIONS OF THE MODELS AND DATA USED

132. The methodology is generic and intended for use with discharges of radionuclides from nuclear energy generating technologies, and a number of non-nuclear electrical energy production sources, throughout the world. It builds on previous work that has provided the Committee with robust results that have been suitable for its purposes. In developing the methodology further, no intentional bias has been introduced to either under- or overestimate radiation exposures; the aim has been to be generic and as realistic as possible. It is difficult to quantify the uncertainties, because of the generic nature of the methodology. Nevertheless, this section outlines the limitations and uncertainties associated with the methodology. The Committee notes the following generic limitations:

- (a) The input to the models is assumed to be a continuous discharge, and annual average parameter values are used. The models therefore do not apply for short-duration planned or accidental releases of radionuclides to the environment;
- (b) Although some parameter values are used that are specific to geographical region (such as for food consumption), most of the models are generic and are not intended for detailed site-specific dose assessments, risk assessments or demonstrating regulatory compliance;
- (c) The assumptions and data used for estimating individual doses are intended to apply to a characteristic individual living local to the discharge point with typical habits and behaviour;
- (d) In order to be realistic rather than cautious in estimating characteristic individual doses, it is assumed that only 25% of food intake (both terrestrial and aquatic) is locally produced. The resulting ingestion doses are sensitive to this assumption, being directly proportional to the food intake, and the overall dose will be similarly sensitive where ingestion is a major component. However, it should be noted that this assumption is not used in the assessment of collective doses;

(e) The assessed collective doses are directly proportional to the assumed population densities for releases to atmosphere or to the assumed total amount of drinking water or aquatic foods for releases to water bodies. The methodology gives results for releases to atmosphere for four different population distributions with values provided by geographical region for three of them. The effect of using different distributions can be seen in the results presented in the following section but are generally only relatively small. However, the use of a very low population density, suitable for remote sites, leads to collective doses around two orders of magnitude lower than when the default population densities are used. Therefore, the value for the very low population density should be used with caution.

(f) The models and data are thought to be the most appropriate for use currently and are also assumed to apply for representing the future. No account is taken of possible future changes, such as to population distributions in different regions or the effects of climate change. The uncertainties in the results of the methodology increase with time; this is particularly the case for global circulation models of long-lived radionuclides when integrated for 10,000 years or more.

133. Specific limitations and uncertainties relating to the different areas of the methodology are noted in the following sections.

## A. Discharges to atmosphere

134. A standard Gaussian-plume model is used to estimate the dispersion of radionuclides following discharges to atmosphere. As discussed in section III.A, the Gaussian model can be implemented generically for assessing exposures from different sources of discharges throughout the world and it produces results that agree reasonably well with measurements [C5]. However, as implemented in the methodology, the model makes no allowance for local topographical features (such as hills, buildings or the site being on the coast) which can strongly influence dispersion, particularly close to the discharge point. The height of the discharge, which is related to both the physical height of the discharge stack and any buoyancy of the discharge caused, for example, by heat (referred to as plume rise), also has a significant effect on the subsequent dispersion of the radionuclides. However, this effect reduces with distance from the discharge point (see electronic attachment 4), and so the Committee agreed to adopt a single value for stack height of 30 m for its generic methodology.

135. A simplified approach has also been retained to account for the deposition of radionuclides in the plume on the ground. An effective deposition velocity of 0.002 m/s is used to represent both dry and wet deposition for all radionuclides (apart from noble gases, tritium and carbon-14, for which, a value of zero is used because noble gases do not deposit, and because deposition is not explicitly modelled for tritium and carbon-14, as they exchange quickly between the atmosphere and ground and a specific activity approach is used instead and). If, for example, a higher deposition velocity were used, it would clearly lead to higher deposition close to the discharge point but lower deposition at greater distances because of depletion of radionuclides in the plume. Thus, overall, for the estimation of collective doses, the effects tend to counteract each other (except for very short-lived radionuclides). However, the estimation of characteristic individual doses is more sensitive to the assumed deposition velocity. Nevertheless, because this methodology is intended for comparative purposes, the Committee considered that the simplified approach was justified.

136. The approach used to estimate the transfer of radionuclides through the terrestrial environment to food is again a standard one. Although the model used, FARMLAND [B6], was developed in the

United Kingdom, it has been validated against measured data [S8] and is in reasonable agreement with models used elsewhere in the world [I6]. Also, to some extent, parameter values that are considered to be widely applicable are used, as discussed in section III. The FARMLAND model was also used in a modified form for the Committee's 2013 assessment of the levels and effects of the nuclear accident following the 2011 great east-Japan earthquake and tsunami [U12]—agricultural practices and parameter values specific to Japan were used. A comparison of the results of the use of two versions of FARMLAND—the one using parameter values that are considered to be widely applicable and the other parameter values that are specific to Japan—are compared in electronic attachment 4. Although there are some differences, these are not significant for the purposes of the methodology.

137. The methodology makes use of consumption rates of terrestrial foods that differ by geographical region (see table 7). This is a compromise between the use of a single diet for the world and more country-specific consumption rates. From table 7, it is clear that there are differences in the total amount of food that is eaten annually, which will have a direct influence on both collective and characteristic individual doses but these are generally less than a factor of two (differences of up to a factor of 5 are seen for individual food types). There are also differences in the composition of the diet, and it is less clear what impact this will have on estimated doses. For discharges from nuclear sites, one of the most important radionuclides in terms of both collective and individual doses is carbon-14 [U8]. A specific-activity model is included in the methodology, so that the intake of carbon-14 is related to the intake of stable carbon in the diet. As carbon is an essential component of the diet and is found in all foods, it is likely that the intake of carbon-14 is insensitive to changes in the dietary composition. This was investigated in a sensitivity study (described in electronic attachment 4) that considered the intakes of carbon for diets typical of Japan and the United Kingdom. This study showed that the total amount of carbon ingested was similar and therefore the dose estimates would be similar even though the foods from which the carbon was derived were different.

138. The estimation of doses due to external exposure from both radionuclides in the plume and those deposited on the ground takes account of the shielding effects of buildings when people are indoors. The methodology uses a single indoor occupancy factor and single shielding/location factors for radionuclides in the plume and those on the ground. The indoor occupancy factor is 0.8 and any variations in this for much of the world are likely to be less than a factor of two and so the effect would be relatively minor. The shielding factors, 0.1 and 0.2 for radionuclides deposited on the ground and in the plume, respectively, are typical of those for standard single-storey buildings. As discussed in section III.A, there are differences between the shielding factors for different building types (shielding factors might be a factor of 5 or 6 higher than used here for wooden buildings and a factor of up to 10 times lower for multi-storey buildings). There is also evidence for location factors changing as a function of time. The empirical models used are based on measurements and there can be good agreement between the results of such models and personal dosimeter measurements where local factors are taken into account. The factors used here are considered to be appropriate for use in the Committee's assessments, recognizing the variations that occur globally

## B. Discharges to freshwater and marine environments

139. The methodology includes consideration of two generic freshwater environments for aquatic discharges: (a) a small river and (b) a large river; the results for a large river are also considered to apply to a large lake. In all cases, instantaneous mixing is assumed within a single body of water, which is obviously a significant simplification. In reality, lakes and rivers are complex environments and rivers have many tributaries and sections with different flow rates, volumes and behaviours. Similarly,

the methodology uses a generic approach for discharges to a marine environment with a simple compartmental model consisting of two compartments representing local and regional marine waters. Again in reality, there are significant differences between marine environments depending on local and regional currents, and the nature of the coastline and local environment. Although there have been validation studies showing good agreement between models and predictions, these are for specific sites and situations and are not necessarily applicable to the simplified generic approach adopted here. However, the Committee considers that its generic approach is adequate for the purpose of assessing worldwide exposures from radioactive discharges and for comparative studies, but notes the limitations of the approach for other purposes.

140. Similar to terrestrial foods, the values for consumption rates of freshwater and marine fish are based on data by geographical region and are suitable for estimating the characteristic individual dose. There are differences in the values of consumption rates for freshwater fish and some marine fish. Table 13 for freshwater fish shows differences of up to a factor of 6 between regions, and table 20 shows differences of a factor of 10 or more for the consumption of crustaceans and even greater differences for consumption rates of molluscs. These differences would be directly reflected in the values of the calculated individual doses.

141. The methodology now considers the transfer of radionuclides from freshwater to terrestrial foods by means of irrigation. There are many different types of irrigation systems and significant variations across the world in their usage, the source of water (surface or groundwater), and the type of crops that are irrigated. The estimation of the transfer of radionuclides to terrestrial foods through irrigation is therefore particularly uncertain. The simplifying assumptions in the methodology however are only intended to be suitable for generic assessments and the Committee considers that its adopted approach is robust enough and suitable for this purpose. Nevertheless, the limitations should be recognized; the importance of these limitations will depend on the relative importance of the irrigation exposure pathway compared to exposures from intakes of drinking water and freshwater fish.

142. The estimation of collective dose from discharges of radionuclides to rivers, lakes and the sea is not based on the sum of individual doses as is the case for discharges to atmosphere. Instead, the collective dose is based on estimates of the total amount of fish caught in the part of the environment of interest, and the amount of water that is abstracted for drinking water and for irrigation. As such, the methodology assumes that the fish, drinking water and irrigated foods are consumed but no account is taken of who consumes them. The Committee considers that this approach is adequate for estimating collective doses for its purposes, but notes that it is not possible with its methodology to break down the collective dose into individual doses or to distinguish between local and regional components of collective dose for any aquatic discharges.

## C. Global modelling

143. The approach used to estimate collective doses from the four most important radionuclides that can be globally dispersed ( $^3\text{H}$ ,  $^{14}\text{C}$ ,  $^{85}\text{Kr}$  and  $^{129}\text{I}$ ) is one that is well accepted and has been used by the Committee for a number of years. The globally dispersed radionuclides, particularly  $^{14}\text{C}$ , are the biggest contributors to the overall collective doses due to discharges from the nuclear industry when these doses are integrated over 500 years or more. One of the factors that influences the estimated collective doses is the size of the global population that is assumed, because the global collective dose is proportional to the size of the global population. A rounded value of 10 billion people is included in the methodology; the uncertainty associated with this value increases with time. The global models are

based on movements of water, carbon and other natural elements through the environment. Such movements are likely to be affected by changes in the climate, sea level, ocean currents and atmospheric conditions. The model for carbon is a specific activity approach based on the global carbon cycle and the amounts of stable carbon in different parts of the environment. Increases in stable carbon due to the burning of fossil fuels will influence the transfers in the future. These possible future changes are not taken into account in the methodology, which leads to increasing uncertainties in estimation of doses in the longer term. It is also not possible to validate this type of model whose scope covers wide areas and time frames.

## D. Comparison of the current and previous methodologies

144. The methodology described in this annex has been developed from that used previously by the Committee [U6, U7, U10]. The main changes that have been made are discussed in electronic attachment 1, with further information given in electronic attachment 2.

145. The main changes that have been introduced are:

- (a) The results of the methodology are now given in terms of the dose per unit discharge rather than being normalized to the amount of electricity generated (dose factors normalized to electricity generated can be calculated subsequently as required);
- (b) The methodology has been extended for application to the estimation of exposures from discharges of radionuclides from non-nuclear electrical energy production;
- (c) The inclusion of factors that depend on geographical region, notably for population distributions, consumption rates and fish-catch data;
- (d) The inclusion of a more detailed approach for modelling the transfer of radionuclides from fresh water to irrigated crops;
- (e) The results are provided for a range of integration times;
- (f) Some updates have been made to the various models included in the methodology.

As noted in electronic attachment 1, many parts of the methodology remain unchanged, because the Committee considered, following review, that they were still appropriate for its purposes.

146. The results of the various workbooks implementing the methodology were compared with data derived from the previous methodology [U6, U7]. The estimates of the annual collective effective doses from the following pathways were compared:

- (a) External exposure due to deposited radionuclides from discharges to atmosphere;
- (b) Inhalation of radionuclides discharged to atmosphere;
- (c) Ingestion of radionuclides discharged to atmosphere;
- (d) All pathways from radionuclides discharged to both freshwater and marine environments.

In general, the results are within about an order of magnitude, despite the changes that have been introduced to parts of the methodology (see electronic attachment 1, tables 2–6).

## VI. APPLICATION OF THE METHODOLOGY

147. The Committee decided that its calculations should be transparent and that the methodology should be able to be relatively easily applied and updated in the future. It agreed that the methodology be implemented in a series of Excel<sup>®</sup> workbooks. The appendix describes the end points considered, the workbook design, the mathematical equations to implement the methodology in the workbooks, the treatment of progeny, the quality assurance carried out to ensure that the workbooks were implemented correctly, and details of how the workbooks could be used for assessing the exposures from different source terms.

148. The results of the methodology, as given by the workbooks, are for specific discharges to different environments. The results are in the form of dose calculation factors for individual radionuclides; for radionuclides that are in secular equilibrium with their short-lived progeny, the factors represent the sums of the contributions from the parent and progeny (see appendix). The factors are for characteristic individual doses (in units of sieverts) in the 100th year of a continuous discharge of a radionuclide at a rate of 1 Bq/s, and collective doses (in units of man-sieverts) integrated to 100, 500 and 10,000 years for a continuous discharge of a radionuclide at a rate of 1 Bq/s for 1 year (see section II.C). For most radionuclides the collective doses to 100 years only are provided because this was deemed to be sufficient. However collective doses integrated to other times are given for <sup>3</sup>H, <sup>14</sup>C, <sup>85</sup>Kr and <sup>129</sup>I.

149. The resulting characteristic individual and collective dose calculation factors for unit discharge of radionuclides to atmosphere, to the different freshwater environments (the results for a large river also apply to a lake) and to a marine environment—derived using the methodology implemented in the workbooks—are presented in tables 23–31. The doses can then be scaled by the actual rates of discharge of each radionuclide from a particular site and then summed over all relevant radionuclides to give the overall characteristic individual and collective doses. Results are given for sites located in different regions of the world, with additional results for coastal and inland nuclear sites and for sites situated in areas of low population density.

150. For future assessments, where discharges are reported to the Committee for broad groups of radionuclides (e.g. gross alpha, noble gases, radioiodines or particulates), some assumptions would need to be made about the proportion of the different radionuclides constituting the group (see section II.D.2).

Table 23. Estimated characteristic individual doses in the 100th year from a continuous discharge of a radionuclide to atmosphere

The characteristic individual dose is to a person living 5 km from the discharge point obtaining 25% of their food locally. The regions are as shown in figure II

Radionuclide	Individual effective dose in the 100th year of a continuous discharge at a rate of 1 Bq/s (Sv)					
	Africa	Asia & Pacific	Europe	Latin America	North America	West Asia
<sup>3</sup> H <sup>a</sup>	$4.2 \times 10^{-14}$	$4.4 \times 10^{-14}$	$4.8 \times 10^{-14}$	$4.3 \times 10^{-14}$	$4.7 \times 10^{-14}$	$4.1 \times 10^{-14}$
<sup>14</sup> C	$3.3 \times 10^{-12}$	$3.7 \times 10^{-12}$	$3.7 \times 10^{-12}$	$3.4 \times 10^{-12}$	$3.6 \times 10^{-12}$	$3.6 \times 10^{-12}$
<sup>35</sup> S	$5.1 \times 10^{-12}$	$7.2 \times 10^{-12}$	$1.4 \times 10^{-11}$	$1.2 \times 10^{-11}$	$1.8 \times 10^{-11}$	$7.6 \times 10^{-12}$
<sup>41</sup> Ar	$4.2 \times 10^{-14}$	$4.2 \times 10^{-14}$	$4.2 \times 10^{-14}$	$4.2 \times 10^{-14}$	$4.2 \times 10^{-14}$	$4.2 \times 10^{-14}$
<sup>54</sup> Mn	$1.5 \times 10^{-12}$	$1.6 \times 10^{-12}$	$1.9 \times 10^{-12}$	$1.7 \times 10^{-12}$	$2.0 \times 10^{-12}$	$1.5 \times 10^{-12}$
<sup>58</sup> Co	$6.4 \times 10^{-12}$	$6.8 \times 10^{-12}$	$7.9 \times 10^{-12}$	$7.4 \times 10^{-12}$	$8.4 \times 10^{-12}$	$6.7 \times 10^{-12}$
<sup>60</sup> Co	$2.3 \times 10^{-10}$	$2.5 \times 10^{-10}$	$3.0 \times 10^{-10}$	$2.9 \times 10^{-10}$	$3.5 \times 10^{-10}$	$2.5 \times 10^{-10}$
<sup>65</sup> Zn	$3.0 \times 10^{-11}$	$3.9 \times 10^{-11}$	$6.7 \times 10^{-11}$	$6.1 \times 10^{-11}$	$8.8 \times 10^{-11}$	$4.0 \times 10^{-11}$
<sup>85</sup> Kr	$8.7 \times 10^{-17}$	$8.7 \times 10^{-17}$	$8.7 \times 10^{-17}$	$8.7 \times 10^{-17}$	$8.7 \times 10^{-17}$	$8.7 \times 10^{-17}$
<sup>90</sup> Sr <sup>b</sup>	$2.4 \times 10^{-10}$	$2.8 \times 10^{-10}$	$3.8 \times 10^{-10}$	$2.9 \times 10^{-10}$	$3.7 \times 10^{-10}$	$2.5 \times 10^{-10}$
<sup>106</sup> Ru <sup>b</sup>	$1.9 \times 10^{-11}$	$2.1 \times 10^{-11}$	$2.9 \times 10^{-11}$	$2.7 \times 10^{-11}$	$3.5 \times 10^{-11}$	$2.1 \times 10^{-11}$
<sup>129</sup> I	$4.3 \times 10^{-10}$	$4.9 \times 10^{-10}$	$5.6 \times 10^{-10}$	$4.6 \times 10^{-10}$	$5.3 \times 10^{-10}$	$4.5 \times 10^{-10}$
<sup>131</sup> I	$1.3 \times 10^{-11}$	$1.5 \times 10^{-11}$	$1.8 \times 10^{-11}$	$1.4 \times 10^{-11}$	$1.7 \times 10^{-11}$	$1.3 \times 10^{-11}$
<sup>133</sup> Xe <sup>b</sup>	$1.0 \times 10^{-15}$	$1.0 \times 10^{-15}$	$1.0 \times 10^{-15}$	$1.0 \times 10^{-15}$	$1.0 \times 10^{-15}$	$1.0 \times 10^{-15}$
<sup>135</sup> Xe	$8.6 \times 10^{-15}$	$8.6 \times 10^{-15}$	$8.6 \times 10^{-15}$	$8.6 \times 10^{-15}$	$8.6 \times 10^{-15}$	$8.6 \times 10^{-15}$
<sup>138</sup> Xe <sup>b</sup>	$3.2 \times 10^{-14}$	$3.2 \times 10^{-14}$	$3.2 \times 10^{-14}$	$3.2 \times 10^{-14}$	$3.2 \times 10^{-14}$	$3.2 \times 10^{-14}$
<sup>134</sup> Cs	$1.2 \times 10^{-10}$	$1.4 \times 10^{-10}$	$1.7 \times 10^{-10}$	$1.5 \times 10^{-10}$	$1.8 \times 10^{-10}$	$1.4 \times 10^{-10}$
<sup>137</sup> Cs <sup>b</sup>	$2.1 \times 10^{-10}$	$2.2 \times 10^{-10}$	$2.4 \times 10^{-10}$	$2.3 \times 10^{-10}$	$2.6 \times 10^{-10}$	$2.2 \times 10^{-10}$
<sup>210</sup> Pb	$1.1 \times 10^{-9}$	$1.2 \times 10^{-9}$	$1.3 \times 10^{-9}$	$1.1 \times 10^{-9}$	$1.2 \times 10^{-9}$	$1.0 \times 10^{-9}$
<sup>210</sup> Po	$2.1 \times 10^{-9}$	$2.3 \times 10^{-9}$	$2.7 \times 10^{-9}$	$2.4 \times 10^{-9}$	$2.8 \times 10^{-9}$	$2.1 \times 10^{-9}$
<sup>222</sup> Rn <sup>b</sup>	$2.7 \times 10^{-12}$	$2.7 \times 10^{-12}$	$2.7 \times 10^{-12}$	$2.7 \times 10^{-12}$	$2.7 \times 10^{-12}$	$2.7 \times 10^{-12}$
<sup>226</sup> Ra	$2.2 \times 10^{-9}$	$2.3 \times 10^{-9}$	$2.4 \times 10^{-9}$	$2.2 \times 10^{-9}$	$2.3 \times 10^{-9}$	$2.1 \times 10^{-9}$
<sup>230</sup> Th	$5.7 \times 10^{-9}$	$5.7 \times 10^{-9}$	$5.7 \times 10^{-9}$	$5.6 \times 10^{-9}$	$5.7 \times 10^{-9}$	$5.6 \times 10^{-9}$
<sup>232</sup> Th <sup>b</sup>	$2.8 \times 10^{-8}$	$2.8 \times 10^{-8}$	$2.8 \times 10^{-8}$	$2.8 \times 10^{-8}$	$2.8 \times 10^{-8}$	$2.8 \times 10^{-8}$
<sup>234</sup> U	$1.4 \times 10^{-9}$	$1.5 \times 10^{-9}$	$1.5 \times 10^{-9}$	$1.5 \times 10^{-9}$	$1.5 \times 10^{-9}$	$1.4 \times 10^{-9}$
<sup>238</sup> U <sup>b</sup>	$1.2 \times 10^{-9}$	$1.2 \times 10^{-9}$	$1.2 \times 10^{-9}$	$1.2 \times 10^{-9}$	$1.2 \times 10^{-9}$	$1.2 \times 10^{-9}$
<sup>239</sup> Pu	$2.0 \times 10^{-8}$	$2.0 \times 10^{-8}$	$2.0 \times 10^{-8}$	$2.0 \times 10^{-8}$	$2.0 \times 10^{-8}$	$2.0 \times 10^{-8}$
<sup>240</sup> Pu	$2.0 \times 10^{-8}$	$2.0 \times 10^{-8}$	$2.0 \times 10^{-8}$	$2.0 \times 10^{-8}$	$2.0 \times 10^{-8}$	$2.0 \times 10^{-8}$
<sup>241</sup> Am	$1.7 \times 10^{-8}$	$1.7 \times 10^{-8}$	$1.7 \times 10^{-8}$	$1.7 \times 10^{-8}$	$1.7 \times 10^{-8}$	$1.7 \times 10^{-8}$

<sup>a</sup> For <sup>3</sup>H the calculated doses include a contribution from HTO and OBT as discussed in section III.A.3.

<sup>b</sup> For these radionuclides the calculated doses include a contribution from the ingrowth of progeny (see appendix for details).

Table 24. Estimated characteristic individual dose in the 100th year of a continuous discharge of a radionuclide to rivers

Characteristic individual doses are to people living 5 km downstream of the discharge point obtaining 25% of their food locally. The regions are as shown in figure II

Radionuclide	Individual effective dose in the 100th year of a continuous discharge at a rate of 1 Bq/s (Sv)											
	Africa		Asia & Pacific		Europe		Latin America		North America		West Asia	
	Small	Large <sup>a</sup>	Small	Large <sup>a</sup>	Small	Large <sup>a</sup>	Small	Large <sup>a</sup>	Small	Large <sup>a</sup>	Small	Large <sup>a</sup>
<sup>3</sup> H <sup>b</sup>	$3.0 \times 10^{-12}$	$3.0 \times 10^{-14}$	$3.0 \times 10^{-12}$	$3.0 \times 10^{-14}$	$3.0 \times 10^{-12}$	$3.0 \times 10^{-14}$	$3.0 \times 10^{-12}$	$3.0 \times 10^{-14}$	$3.0 \times 10^{-12}$	$3.0 \times 10^{-14}$	$3.0 \times 10^{-12}$	$3.0 \times 10^{-14}$
<sup>14</sup> C	$1.6 \times 10^{-8}$	$1.6 \times 10^{-10}$	$4.5 \times 10^{-8}$	$4.5 \times 10^{-10}$	$2.0 \times 10^{-8}$	$2.0 \times 10^{-10}$	$9.3 \times 10^{-9}$	$9.4 \times 10^{-11}$	$2.6 \times 10^{-8}$	$2.6 \times 10^{-10}$	$7.6 \times 10^{-9}$	$7.8 \times 10^{-11}$
<sup>35</sup> S	$6.2 \times 10^{-11}$	$6.5 \times 10^{-13}$	$1.4 \times 10^{-10}$	$1.3 \times 10^{-12}$	$7.3 \times 10^{-11}$	$8.0 \times 10^{-13}$	$4.5 \times 10^{-11}$	$4.9 \times 10^{-13}$	$9.0 \times 10^{-11}$	$9.6 \times 10^{-13}$	$4.1 \times 10^{-11}$	$4.7 \times 10^{-13}$
<sup>54</sup> Mn	$5.2 \times 10^{-9}$	$3.5 \times 10^{-12}$	$5.3 \times 10^{-9}$	$3.5 \times 10^{-12}$	$5.2 \times 10^{-9}$	$3.5 \times 10^{-12}$	$5.2 \times 10^{-9}$	$3.5 \times 10^{-12}$	$5.2 \times 10^{-9}$	$3.5 \times 10^{-12}$	$5.2 \times 10^{-9}$	$3.5 \times 10^{-12}$
<sup>58</sup> Co	$4.7 \times 10^{-9}$	$4.0 \times 10^{-12}$	$4.7 \times 10^{-9}$	$4.0 \times 10^{-12}$	$4.7 \times 10^{-9}$	$4.1 \times 10^{-12}$	$4.7 \times 10^{-9}$	$4.0 \times 10^{-12}$	$4.7 \times 10^{-9}$	$4.1 \times 10^{-12}$	$4.7 \times 10^{-9}$	$4.0 \times 10^{-12}$
<sup>60</sup> Co	$1.2 \times 10^{-8}$	$1.1 \times 10^{-11}$	$1.2 \times 10^{-8}$	$1.1 \times 10^{-11}$	$1.2 \times 10^{-8}$	$1.1 \times 10^{-11}$	$1.2 \times 10^{-8}$	$1.1 \times 10^{-11}$	$1.2 \times 10^{-8}$	$1.1 \times 10^{-11}$	$1.2 \times 10^{-8}$	$1.1 \times 10^{-11}$
<sup>65</sup> Zn	$1.0 \times 10^{-9}$	$9.0 \times 10^{-12}$	$2.7 \times 10^{-9}$	$2.2 \times 10^{-11}$	$1.3 \times 10^{-9}$	$1.1 \times 10^{-11}$	$6.9 \times 10^{-10}$	$6.1 \times 10^{-12}$	$1.6 \times 10^{-9}$	$1.4 \times 10^{-11}$	$5.9 \times 10^{-10}$	$5.3 \times 10^{-12}$
<sup>90</sup> Sr <sup>c</sup>	$1.2 \times 10^{-9}$	$1.9 \times 10^{-11}$	$1.2 \times 10^{-9}$	$1.5 \times 10^{-11}$	$1.2 \times 10^{-9}$	$2.7 \times 10^{-11}$	$1.2 \times 10^{-9}$	$1.9 \times 10^{-11}$	$1.2 \times 10^{-9}$	$2.8 \times 10^{-11}$	$1.2 \times 10^{-9}$	$2.0 \times 10^{-11}$
<sup>106</sup> Ru <sup>c</sup>	$1.7 \times 10^{-9}$	$3.5 \times 10^{-12}$	$1.7 \times 10^{-9}$	$3.4 \times 10^{-12}$	$1.7 \times 10^{-9}$	$3.7 \times 10^{-12}$	$1.7 \times 10^{-9}$	$3.5 \times 10^{-12}$	$1.7 \times 10^{-9}$	$3.8 \times 10^{-12}$	$1.6 \times 10^{-9}$	$3.5 \times 10^{-12}$
<sup>129</sup> I	$4.7 \times 10^{-9}$	$6.1 \times 10^{-11}$	$5.1 \times 10^{-9}$	$5.3 \times 10^{-11}$	$4.7 \times 10^{-9}$	$7.4 \times 10^{-11}$	$4.6 \times 10^{-9}$	$5.9 \times 10^{-11}$	$4.8 \times 10^{-9}$	$7.6 \times 10^{-11}$	$4.6 \times 10^{-9}$	$6.3 \times 10^{-11}$
<sup>131</sup> I	$4.0 \times 10^{-10}$	$1.9 \times 10^{-12}$	$4.0 \times 10^{-10}$	$1.9 \times 10^{-12}$	$4.0 \times 10^{-10}$	$2.0 \times 10^{-12}$	$4.0 \times 10^{-10}$	$1.9 \times 10^{-12}$	$4.0 \times 10^{-10}$	$2.0 \times 10^{-12}$	$4.0 \times 10^{-10}$	$1.9 \times 10^{-12}$
<sup>134</sup> Cs	$8.6 \times 10^{-9}$	$1.8 \times 10^{-11}$	$1.2 \times 10^{-8}$	$2.1 \times 10^{-11}$	$9.2 \times 10^{-9}$	$2.0 \times 10^{-11}$	$7.8 \times 10^{-9}$	$1.7 \times 10^{-11}$	$1.0 \times 10^{-8}$	$2.1 \times 10^{-11}$	$7.6 \times 10^{-9}$	$1.7 \times 10^{-11}$
<sup>137</sup> Cs <sup>c</sup>	$4.1 \times 10^{-9}$	$1.1 \times 10^{-11}$	$6.7 \times 10^{-9}$	$1.2 \times 10^{-11}$	$4.5 \times 10^{-9}$	$1.2 \times 10^{-11}$	$3.5 \times 10^{-9}$	$9.9 \times 10^{-12}$	$5.0 \times 10^{-9}$	$1.3 \times 10^{-11}$	$3.4 \times 10^{-9}$	$1.0 \times 10^{-11}$
<sup>210</sup> Pb	$2.0 \times 10^{-8}$	$2.2 \times 10^{-10}$	$2.1 \times 10^{-8}$	$2.0 \times 10^{-10}$	$2.0 \times 10^{-8}$	$2.5 \times 10^{-10}$	$1.9 \times 10^{-8}$	$2.1 \times 10^{-10}$	$2.0 \times 10^{-8}$	$2.6 \times 10^{-10}$	$1.9 \times 10^{-8}$	$2.2 \times 10^{-10}$
<sup>210</sup> Po	$3.4 \times 10^{-8}$	$3.5 \times 10^{-10}$	$3.7 \times 10^{-8}$	$3.4 \times 10^{-10}$	$3.4 \times 10^{-8}$	$3.9 \times 10^{-10}$	$3.3 \times 10^{-8}$	$3.5 \times 10^{-10}$	$3.5 \times 10^{-8}$	$4.0 \times 10^{-10}$	$3.3 \times 10^{-8}$	$3.5 \times 10^{-10}$
<sup>226</sup> Ra	$7.6 \times 10^{-9}$	$1.1 \times 10^{-10}$	$7.8 \times 10^{-9}$	$9.0 \times 10^{-11}$	$7.7 \times 10^{-9}$	$1.4 \times 10^{-10}$	$7.6 \times 10^{-9}$	$1.0 \times 10^{-10}$	$7.7 \times 10^{-9}$	$1.4 \times 10^{-10}$	$7.6 \times 10^{-9}$	$1.1 \times 10^{-10}$
<sup>230</sup> Th	$3.2 \times 10^{-9}$	$3.7 \times 10^{-11}$	$3.2 \times 10^{-9}$	$3.4 \times 10^{-11}$	$3.2 \times 10^{-9}$	$4.4 \times 10^{-11}$	$3.2 \times 10^{-9}$	$3.7 \times 10^{-11}$	$3.2 \times 10^{-9}$	$4.6 \times 10^{-11}$	$3.2 \times 10^{-9}$	$3.7 \times 10^{-11}$
<sup>232</sup> Th <sup>c</sup>	$3.3 \times 10^{-8}$	$2.8 \times 10^{-10}$	$3.3 \times 10^{-8}$	$2.5 \times 10^{-10}$	$3.3 \times 10^{-8}$	$3.2 \times 10^{-10}$	$3.3 \times 10^{-8}$	$2.7 \times 10^{-10}$	$3.3 \times 10^{-8}$	$3.3 \times 10^{-10}$	$3.3 \times 10^{-8}$	$2.8 \times 10^{-10}$
<sup>234</sup> U	$7.4 \times 10^{-10}$	$9.6 \times 10^{-12}$	$7.4 \times 10^{-10}$	$8.4 \times 10^{-12}$	$7.4 \times 10^{-10}$	$1.2 \times 10^{-11}$	$7.4 \times 10^{-10}$	$9.5 \times 10^{-12}$	$7.4 \times 10^{-10}$	$1.3 \times 10^{-11}$	$7.4 \times 10^{-10}$	$9.7 \times 10^{-12}$
<sup>238</sup> U <sup>c</sup>	$7.3 \times 10^{-10}$	$9.4 \times 10^{-12}$	$7.4 \times 10^{-10}$	$8.3 \times 10^{-12}$	$7.3 \times 10^{-10}$	$1.2 \times 10^{-11}$	$7.3 \times 10^{-10}$	$9.3 \times 10^{-12}$	$7.3 \times 10^{-10}$	$1.2 \times 10^{-11}$	$7.3 \times 10^{-10}$	$9.5 \times 10^{-12}$
<sup>239</sup> Pu	$3.5 \times 10^{-9}$	$4.1 \times 10^{-11}$	$3.6 \times 10^{-9}$	$3.7 \times 10^{-11}$	$3.5 \times 10^{-9}$	$4.9 \times 10^{-11}$	$3.4 \times 10^{-9}$	$4.1 \times 10^{-11}$	$3.5 \times 10^{-9}$	$5.1 \times 10^{-11}$	$3.4 \times 10^{-9}$	$4.1 \times 10^{-11}$
<sup>240</sup> Pu	$3.5 \times 10^{-9}$	$4.1 \times 10^{-11}$	$3.6 \times 10^{-9}$	$3.7 \times 10^{-11}$	$3.5 \times 10^{-9}$	$4.9 \times 10^{-11}$	$3.4 \times 10^{-9}$	$4.1 \times 10^{-11}$	$3.5 \times 10^{-9}$	$5.1 \times 10^{-11}$	$3.4 \times 10^{-9}$	$4.1 \times 10^{-11}$
<sup>241</sup> Am	$3.8 \times 10^{-9}$	$3.4 \times 10^{-11}$	$5.6 \times 10^{-9}$	$3.1 \times 10^{-11}$	$4.1 \times 10^{-9}$	$4.1 \times 10^{-11}$	$3.4 \times 10^{-9}$	$3.3 \times 10^{-11}$	$4.5 \times 10^{-9}$	$4.3 \times 10^{-11}$	$3.3 \times 10^{-9}$	$3.3 \times 10^{-11}$

<sup>a</sup> The dose estimates for large rivers are also assumed to apply to lakes.

<sup>b</sup> For <sup>3</sup>H the calculated doses include a contribution from HTO and OBT as discussed in section III.A.3.

<sup>c</sup> For these radionuclides the calculated doses include a contribution from the ingrowth of progeny (see appendix for details).



Table 25. Estimated characteristic individual dose in the 100th year of a continuous discharge of a radionuclide to a marine environment

The characteristic individual dose is for people ingesting crustaceans and molluscs from the local marine compartment plus 25% of their marine fish consumption from the local compartment and 75% from the regional compartment. The regions are as shown in figure II

Radionuclide	Individual effective dose in the 100th year of a continuous discharge at a rate of 1 Bq/s (Sv)					
	Africa	Asia and Pacific	Europe	Latin America	North America	West Asia
<sup>3</sup> H	$5.0 \times 10^{-17}$	$1.6 \times 10^{-16}$	$1.5 \times 10^{-16}$	$7.0 \times 10^{-17}$	$1.7 \times 10^{-16}$	$4.0 \times 10^{-17}$
<sup>14</sup> C	$3.2 \times 10^{-11}$	$1.0 \times 10^{-10}$	$9.4 \times 10^{-11}$	$4.5 \times 10^{-11}$	$1.1 \times 10^{-10}$	$2.6 \times 10^{-11}$
<sup>35</sup> S	$1.9 \times 10^{-15}$	$1.1 \times 10^{-14}$	$7.6 \times 10^{-15}$	$3.5 \times 10^{-15}$	$9.5 \times 10^{-15}$	$1.5 \times 10^{-15}$
<sup>54</sup> Mn	$2.6 \times 10^{-9}$	$5.3 \times 10^{-9}$	$5.2 \times 10^{-9}$	$5.2 \times 10^{-9}$	$5.3 \times 10^{-9}$	$5.2 \times 10^{-9}$
<sup>58</sup> Co	$4.0 \times 10^{-10}$	$8.6 \times 10^{-10}$	$8.3 \times 10^{-10}$	$8.1 \times 10^{-10}$	$8.5 \times 10^{-10}$	$8.0 \times 10^{-10}$
<sup>60</sup> Co	$1.2 \times 10^{-9}$	$2.6 \times 10^{-9}$	$2.5 \times 10^{-9}$	$2.4 \times 10^{-9}$	$2.6 \times 10^{-9}$	$2.3 \times 10^{-9}$
<sup>65</sup> Zn	$2.8 \times 10^{-10}$	$3.7 \times 10^{-9}$	$2.1 \times 10^{-9}$	$1.4 \times 10^{-9}$	$5.6 \times 10^{-9}$	$5.9 \times 10^{-10}$
<sup>90</sup> Sr <sup>a</sup>	$2.5 \times 10^{-13}$	$1.6 \times 10^{-12}$	$1.1 \times 10^{-12}$	$5.1 \times 10^{-13}$	$1.5 \times 10^{-12}$	$2.2 \times 10^{-13}$
<sup>106</sup> Ru <sup>a</sup>	$2.3 \times 10^{-11}$	$6.0 \times 10^{-11}$	$5.2 \times 10^{-11}$	$4.8 \times 10^{-11}$	$5.6 \times 10^{-11}$	$4.6 \times 10^{-11}$
<sup>129</sup> I	$2.7 \times 10^{-12}$	$7.6 \times 10^{-12}$	$7.3 \times 10^{-12}$	$3.3 \times 10^{-12}$	$7.0 \times 10^{-12}$	$1.9 \times 10^{-12}$
<sup>131</sup> I	$3.6 \times 10^{-14}$	$8.8 \times 10^{-14}$	$8.5 \times 10^{-14}$	$5.7 \times 10^{-14}$	$8.3 \times 10^{-14}$	$4.7 \times 10^{-14}$
<sup>134</sup> Cs	$1.5 \times 10^{-11}$	$3.1 \times 10^{-11}$	$3.2 \times 10^{-11}$	$2.6 \times 10^{-11}$	$3.2 \times 10^{-11}$	$2.4 \times 10^{-11}$
<sup>137</sup> Cs <sup>a</sup>	$7.2 \times 10^{-12}$	$1.5 \times 10^{-11}$	$1.6 \times 10^{-11}$	$1.2 \times 10^{-11}$	$1.6 \times 10^{-11}$	$1.0 \times 10^{-11}$
<sup>210</sup> Pb <sup>a</sup>	$2.3 \times 10^{-8}$	$4.2 \times 10^{-7}$	$2.2 \times 10^{-7}$	$1.2 \times 10^{-7}$	$5.1 \times 10^{-7}$	$4.1 \times 10^{-8}$
<sup>210</sup> Po	$1.0 \times 10^{-8}$	$1.4 \times 10^{-7}$	$7.5 \times 10^{-8}$	$4.0 \times 10^{-8}$	$1.5 \times 10^{-7}$	$1.3 \times 10^{-8}$
<sup>226</sup> Ra <sup>a</sup>	$2.4 \times 10^{-8}$	$4.2 \times 10^{-7}$	$2.2 \times 10^{-7}$	$1.3 \times 10^{-7}$	$5.1 \times 10^{-7}$	$4.1 \times 10^{-8}$
<sup>230</sup> Th	$3.7 \times 10^{-10}$	$1.6 \times 10^{-9}$	$1.3 \times 10^{-9}$	$6.3 \times 10^{-10}$	$1.8 \times 10^{-9}$	$3.2 \times 10^{-10}$
<sup>232</sup> Th <sup>a</sup>	$6.3 \times 10^{-9}$	$1.6 \times 10^{-8}$	$1.5 \times 10^{-8}$	$1.3 \times 10^{-8}$	$1.7 \times 10^{-8}$	$1.2 \times 10^{-8}$
<sup>234</sup> U	$2.5 \times 10^{-13}$	$6.8 \times 10^{-12}$	$3.2 \times 10^{-12}$	$1.5 \times 10^{-12}$	$5.5 \times 10^{-12}$	$3.3 \times 10^{-13}$
<sup>238</sup> U <sup>a</sup>	$6.4 \times 10^{-12}$	$3.3 \times 10^{-11}$	$2.4 \times 10^{-11}$	$1.2 \times 10^{-11}$	$3.4 \times 10^{-11}$	$5.8 \times 10^{-12}$
<sup>239</sup> Pu	$9.1 \times 10^{-11}$	$3.0 \times 10^{-9}$	$1.4 \times 10^{-9}$	$5.7 \times 10^{-10}$	$1.9 \times 10^{-9}$	$8.5 \times 10^{-11}$
<sup>240</sup> Pu	$9.1 \times 10^{-11}$	$3.0 \times 10^{-9}$	$1.4 \times 10^{-9}$	$5.7 \times 10^{-10}$	$1.9 \times 10^{-9}$	$8.5 \times 10^{-11}$
<sup>241</sup> Am	$1.5 \times 10^{-10}$	$1.2 \times 10^{-9}$	$6.8 \times 10^{-10}$	$4.0 \times 10^{-10}$	$1.0 \times 10^{-9}$	$2.3 \times 10^{-10}$

<sup>a</sup> For these radionuclides the calculated doses include a contribution from the ingrowth of progeny (see appendix for details).

Table 26. Local and regional components of collective dose for discharges to atmosphere from sites in different regions of the world

The collective doses are out to 1,500 km based on the population distributions given in table 3 for different regions of the world as shown in figure II. They can be used for discharges from any type of source for comparative purposes and are the only values appropriate for non-nuclear sites

Radio-nuclide	Collective doses integrated to 100 years from a year's continuous discharge at a rate of 1 Bq/s (man Sv)													
	Africa		Asia and Pacific		Europe		Latin America		North America		West Asia		World average <sup>a</sup>	
	Local	Regional	Local	Regional	Local	Regional	Local	Regional	Local	Regional	Local	Regional	Local	Regional
<sup>3</sup> H <sup>b</sup>	$1.4 \times 10^{-8}$	$1.2 \times 10^{-7}$	$5.6 \times 10^{-8}$	$4.7 \times 10^{-7}$	$3.0 \times 10^{-8}$	$2.5 \times 10^{-7}$	$2.6 \times 10^{-8}$	$2.2 \times 10^{-7}$	$7.3 \times 10^{-9}$	$6.0 \times 10^{-8}$	$1.8 \times 10^{-8}$	$1.5 \times 10^{-7}$	$3.2 \times 10^{-8}$	$2.7 \times 10^{-7}$
<sup>14</sup> C	$1.1 \times 10^{-6}$	$5.3 \times 10^{-6}$	$4.3 \times 10^{-6}$	$2.2 \times 10^{-5}$	$2.0 \times 10^{-6}$	$1.0 \times 10^{-5}$	$1.9 \times 10^{-6}$	$9.7 \times 10^{-6}$	$4.9 \times 10^{-7}$	$2.5 \times 10^{-6}$	$1.5 \times 10^{-6}$	$7.8 \times 10^{-6}$	$2.4 \times 10^{-6}$	$1.2 \times 10^{-5}$
<sup>35</sup> S	$1.8 \times 10^{-6}$	$8.2 \times 10^{-6}$	$9.1 \times 10^{-6}$	$4.2 \times 10^{-5}$	$8.2 \times 10^{-6}$	$3.8 \times 10^{-5}$	$7.5 \times 10^{-6}$	$3.5 \times 10^{-5}$	$2.7 \times 10^{-6}$	$1.3 \times 10^{-5}$	$3.5 \times 10^{-6}$	$1.6 \times 10^{-5}$	$6.9 \times 10^{-6}$	$3.2 \times 10^{-5}$
<sup>41</sup> Ar	$6.1 \times 10^{-10}$	$3.2 \times 10^{-15}$	$2.2 \times 10^{-9}$	$1.1 \times 10^{-14}$	$9.8 \times 10^{-10}$	$5.2 \times 10^{-15}$	$1.0 \times 10^{-9}$	$5.5 \times 10^{-15}$	$2.5 \times 10^{-10}$	$1.3 \times 10^{-15}$	$7.9 \times 10^{-10}$	$4.2 \times 10^{-15}$	$1.2 \times 10^{-9}$	$6.5 \times 10^{-15}$
<sup>54</sup> Mn	$3.8 \times 10^{-7}$	$1.8 \times 10^{-6}$	$1.6 \times 10^{-6}$	$7.4 \times 10^{-6}$	$9.0 \times 10^{-7}$	$4.3 \times 10^{-6}$	$7.8 \times 10^{-7}$	$3.7 \times 10^{-6}$	$2.3 \times 10^{-7}$	$1.1 \times 10^{-6}$	$5.0 \times 10^{-7}$	$2.4 \times 10^{-6}$	$9.2 \times 10^{-7}$	$4.4 \times 10^{-6}$
<sup>58</sup> Co	$8.9 \times 10^{-7}$	$4.1 \times 10^{-6}$	$3.6 \times 10^{-6}$	$1.7 \times 10^{-5}$	$2.4 \times 10^{-6}$	$1.1 \times 10^{-5}$	$2.2 \times 10^{-6}$	$1.0 \times 10^{-5}$	$6.7 \times 10^{-7}$	$3.1 \times 10^{-6}$	$1.3 \times 10^{-6}$	$6.0 \times 10^{-6}$	$2.3 \times 10^{-6}$	$1.1 \times 10^{-5}$
<sup>60</sup> Co	$3.0 \times 10^{-5}$	$1.4 \times 10^{-4}$	$1.3 \times 10^{-4}$	$6.3 \times 10^{-4}$	$9.6 \times 10^{-5}$	$4.6 \times 10^{-4}$	$9.4 \times 10^{-5}$	$4.5 \times 10^{-4}$	$3.1 \times 10^{-5}$	$1.5 \times 10^{-4}$	$5.0 \times 10^{-5}$	$2.4 \times 10^{-4}$	$9.1 \times 10^{-5}$	$4.3 \times 10^{-4}$
<sup>65</sup> Zn	$8.5 \times 10^{-6}$	$4.0 \times 10^{-5}$	$4.3 \times 10^{-5}$	$2.0 \times 10^{-4}$	$3.7 \times 10^{-5}$	$1.7 \times 10^{-4}$	$3.5 \times 10^{-5}$	$1.6 \times 10^{-4}$	$1.2 \times 10^{-5}$	$5.9 \times 10^{-5}$	$1.6 \times 10^{-5}$	$7.6 \times 10^{-5}$	$3.2 \times 10^{-5}$	$1.5 \times 10^{-4}$
<sup>85</sup> Kr	$1.4 \times 10^{-11}$	$1.1 \times 10^{-10}$	$4.8 \times 10^{-11}$	$4.0 \times 10^{-10}$	$2.2 \times 10^{-11}$	$1.8 \times 10^{-10}$	$2.3 \times 10^{-11}$	$1.9 \times 10^{-10}$	$5.5 \times 10^{-12}$	$4.6 \times 10^{-11}$	$1.8 \times 10^{-11}$	$1.5 \times 10^{-10}$	$2.7 \times 10^{-11}$	$2.3 \times 10^{-10}$
<sup>90</sup> Sr <sup>c</sup>	$8.7 \times 10^{-5}$	$4.2 \times 10^{-4}$	$3.6 \times 10^{-4}$	$1.7 \times 10^{-3}$	$2.3 \times 10^{-4}$	$1.1 \times 10^{-3}$	$1.8 \times 10^{-4}$	$8.6 \times 10^{-4}$	$5.5 \times 10^{-5}$	$2.6 \times 10^{-4}$	$1.2 \times 10^{-4}$	$5.5 \times 10^{-4}$	$2.2 \times 10^{-4}$	$1.0 \times 10^{-3}$
<sup>106</sup> Ru <sup>c</sup>	$3.9 \times 10^{-6}$	$1.9 \times 10^{-5}$	$1.8 \times 10^{-5}$	$8.4 \times 10^{-5}$	$1.3 \times 10^{-5}$	$5.9 \times 10^{-5}$	$1.2 \times 10^{-5}$	$5.7 \times 10^{-5}$	$4.1 \times 10^{-6}$	$1.9 \times 10^{-5}$	$6.2 \times 10^{-6}$	$3.0 \times 10^{-5}$	$1.2 \times 10^{-5}$	$5.6 \times 10^{-5}$
<sup>129</sup> I	$1.6 \times 10^{-4}$	$7.6 \times 10^{-4}$	$6.4 \times 10^{-4}$	$3.1 \times 10^{-3}$	$3.3 \times 10^{-4}$	$1.6 \times 10^{-3}$	$2.9 \times 10^{-4}$	$1.4 \times 10^{-3}$	$7.9 \times 10^{-5}$	$3.8 \times 10^{-4}$	$2.1 \times 10^{-4}$	$1.0 \times 10^{-3}$	$3.6 \times 10^{-4}$	$1.7 \times 10^{-3}$
<sup>131</sup> I	$3.9 \times 10^{-6}$	$1.4 \times 10^{-5}$	$1.6 \times 10^{-5}$	$5.6 \times 10^{-5}$	$9.3 \times 10^{-6}$	$3.2 \times 10^{-5}$	$7.6 \times 10^{-6}$	$2.7 \times 10^{-5}$	$2.2 \times 10^{-6}$	$7.9 \times 10^{-6}$	$5.1 \times 10^{-6}$	$1.8 \times 10^{-5}$	$9.3 \times 10^{-6}$	$3.2 \times 10^{-5}$
<sup>133</sup> Xe <sup>c</sup>	$1.6 \times 10^{-10}$	$8.0 \times 10^{-10}$	$5.6 \times 10^{-10}$	$2.9 \times 10^{-9}$	$2.6 \times 10^{-10}$	$1.3 \times 10^{-9}$	$2.7 \times 10^{-10}$	$1.4 \times 10^{-9}$	$6.5 \times 10^{-11}$	$3.3 \times 10^{-10}$	$2.1 \times 10^{-10}$	$1.0 \times 10^{-9}$	$3.2 \times 10^{-10}$	$1.6 \times 10^{-9}$
<sup>135</sup> Xe	$8.3 \times 10^{-10}$	$1.7 \times 10^{-10}$	$3.0 \times 10^{-9}$	$5.9 \times 10^{-10}$	$1.4 \times 10^{-9}$	$2.7 \times 10^{-10}$	$1.4 \times 10^{-9}$	$2.9 \times 10^{-10}$	$3.4 \times 10^{-10}$	$6.8 \times 10^{-11}$	$1.1 \times 10^{-9}$	$2.2 \times 10^{-10}$	$1.7 \times 10^{-9}$	$3.4 \times 10^{-10}$
<sup>138</sup> Xe <sup>c</sup>	$1.9 \times 10^{-12}$	$1.7 \times 10^{-31}$	$6.7 \times 10^{-12}$	$6.2 \times 10^{-31}$	$3.0 \times 10^{-12}$	$2.8 \times 10^{-31}$	$3.2 \times 10^{-12}$	$3.0 \times 10^{-31}$	$7.7 \times 10^{-13}$	$7.1 \times 10^{-32}$	$2.4 \times 10^{-12}$	$2.3 \times 10^{-31}$	$3.8 \times 10^{-12}$	$3.5 \times 10^{-31}$
<sup>134</sup> Cs	$2.9 \times 10^{-5}$	$1.4 \times 10^{-4}$	$1.2 \times 10^{-4}$	$5.9 \times 10^{-4}$	$7.3 \times 10^{-5}$	$3.5 \times 10^{-4}$	$6.9 \times 10^{-5}$	$3.3 \times 10^{-4}$	$2.1 \times 10^{-5}$	$9.9 \times 10^{-5}$	$4.4 \times 10^{-5}$	$2.1 \times 10^{-4}$	$7.5 \times 10^{-5}$	$3.6 \times 10^{-4}$
<sup>137</sup> Cs <sup>c</sup>	$3.5 \times 10^{-5}$	$1.7 \times 10^{-4}$	$1.4 \times 10^{-4}$	$6.8 \times 10^{-4}$	$7.9 \times 10^{-5}$	$3.8 \times 10^{-4}$	$7.6 \times 10^{-5}$	$3.6 \times 10^{-4}$	$2.2 \times 10^{-5}$	$1.0 \times 10^{-4}$	$5.0 \times 10^{-5}$	$2.4 \times 10^{-4}$	$8.5 \times 10^{-5}$	$4.1 \times 10^{-4}$
<sup>210</sup> Pb	$3.0 \times 10^{-4}$	$1.4 \times 10^{-3}$	$1.2 \times 10^{-3}$	$5.5 \times 10^{-3}$	$6.0 \times 10^{-4}$	$2.9 \times 10^{-3}$	$5.0 \times 10^{-4}$	$2.4 \times 10^{-3}$	$1.4 \times 10^{-4}$	$6.7 \times 10^{-4}$	$3.5 \times 10^{-4}$	$1.7 \times 10^{-3}$	$6.4 \times 10^{-4}$	$3.1 \times 10^{-3}$
<sup>210</sup> Po	$4.4 \times 10^{-4}$	$2.1 \times 10^{-3}$	$1.7 \times 10^{-3}$	$8.2 \times 10^{-3}$	$1.1 \times 10^{-3}$	$5.0 \times 10^{-3}$	$9.0 \times 10^{-4}$	$4.2 \times 10^{-3}$	$2.8 \times 10^{-4}$	$1.3 \times 10^{-3}$	$5.5 \times 10^{-4}$	$2.6 \times 10^{-3}$	$1.0 \times 10^{-3}$	$4.9 \times 10^{-3}$
<sup>222</sup> Rn <sup>c</sup>	$4.0 \times 10^{-7}$	$1.7 \times 10^{-6}$	$1.4 \times 10^{-6}$	$6.0 \times 10^{-6}$	$6.4 \times 10^{-7}$	$2.8 \times 10^{-6}$	$6.8 \times 10^{-7}$	$2.9 \times 10^{-6}$	$1.6 \times 10^{-7}$	$6.9 \times 10^{-7}$	$5.1 \times 10^{-7}$	$2.2 \times 10^{-6}$	$8.0 \times 10^{-7}$	$3.4 \times 10^{-6}$
<sup>226</sup> Ra	$4.3 \times 10^{-4}$	$2.1 \times 10^{-3}$	$1.7 \times 10^{-3}$	$8.0 \times 10^{-3}$	$8.4 \times 10^{-4}$	$4.0 \times 10^{-3}$	$7.4 \times 10^{-4}$	$3.5 \times 10^{-3}$	$2.0 \times 10^{-4}$	$9.5 \times 10^{-4}$	$5.4 \times 10^{-4}$	$2.6 \times 10^{-3}$	$9.3 \times 10^{-4}$	$4.4 \times 10^{-3}$

Radio-nuclide	Collective doses integrated to 100 years from a year's continuous discharge at a rate of 1 Bq/s (man Sv)													
	Africa		Asia and Pacific		Europe		Latin America		North America		West Asia		World average <sup>a</sup>	
	Local	Regional	Local	Regional	Local	Regional	Local	Regional	Local	Regional	Local	Regional	Local	Regional
<sup>230</sup> Th	$5.7 \times 10^{-4}$	$2.7 \times 10^{-3}$	$2.0 \times 10^{-3}$	$9.8 \times 10^{-3}$	$9.5 \times 10^{-4}$	$4.5 \times 10^{-3}$	$9.8 \times 10^{-4}$	$4.7 \times 10^{-3}$	$2.4 \times 10^{-4}$	$1.1 \times 10^{-3}$	$7.3 \times 10^{-4}$	$3.5 \times 10^{-3}$	$1.2 \times 10^{-3}$	$5.5 \times 10^{-3}$
<sup>232</sup> Th <sup>c</sup>	$2.9 \times 10^{-3}$	$1.4 \times 10^{-2}$	$1.0 \times 10^{-2}$	$5.0 \times 10^{-2}$	$4.9 \times 10^{-3}$	$2.3 \times 10^{-2}$	$5.0 \times 10^{-3}$	$2.4 \times 10^{-2}$	$1.2 \times 10^{-3}$	$5.8 \times 10^{-3}$	$3.7 \times 10^{-3}$	$1.8 \times 10^{-2}$	$5.9 \times 10^{-3}$	$2.8 \times 10^{-2}$
<sup>234</sup> U	$1.5 \times 10^{-4}$	$7.3 \times 10^{-4}$	$5.6 \times 10^{-4}$	$2.7 \times 10^{-3}$	$2.7 \times 10^{-4}$	$1.3 \times 10^{-3}$	$2.7 \times 10^{-4}$	$1.3 \times 10^{-3}$	$6.9 \times 10^{-5}$	$3.3 \times 10^{-4}$	$2.0 \times 10^{-4}$	$9.5 \times 10^{-4}$	$3.2 \times 10^{-4}$	$1.5 \times 10^{-3}$
<sup>238</sup> U <sup>c</sup>	$1.3 \times 10^{-4}$	$6.2 \times 10^{-4}$	$4.8 \times 10^{-4}$	$2.3 \times 10^{-3}$	$2.3 \times 10^{-4}$	$1.1 \times 10^{-3}$	$2.3 \times 10^{-4}$	$1.1 \times 10^{-3}$	$5.9 \times 10^{-5}$	$2.8 \times 10^{-4}$	$1.7 \times 10^{-4}$	$8.1 \times 10^{-4}$	$2.7 \times 10^{-4}$	$1.3 \times 10^{-3}$
<sup>239</sup> Pu	$1.9 \times 10^{-3}$	$9.2 \times 10^{-3}$	$6.8 \times 10^{-3}$	$3.3 \times 10^{-2}$	$3.1 \times 10^{-3}$	$1.5 \times 10^{-2}$	$3.3 \times 10^{-3}$	$1.6 \times 10^{-2}$	$7.9 \times 10^{-4}$	$3.8 \times 10^{-3}$	$2.5 \times 10^{-3}$	$1.2 \times 10^{-2}$	$3.9 \times 10^{-3}$	$1.9 \times 10^{-2}$
<sup>240</sup> Pu	$1.9 \times 10^{-3}$	$9.2 \times 10^{-3}$	$6.8 \times 10^{-3}$	$3.3 \times 10^{-2}$	$3.1 \times 10^{-3}$	$1.5 \times 10^{-2}$	$3.3 \times 10^{-3}$	$1.6 \times 10^{-2}$	$7.9 \times 10^{-4}$	$3.8 \times 10^{-3}$	$2.5 \times 10^{-3}$	$1.2 \times 10^{-2}$	$3.9 \times 10^{-3}$	$1.9 \times 10^{-2}$
<sup>241</sup> Am	$1.6 \times 10^{-3}$	$7.7 \times 10^{-3}$	$5.7 \times 10^{-3}$	$2.7 \times 10^{-2}$	$2.6 \times 10^{-3}$	$1.3 \times 10^{-2}$	$2.8 \times 10^{-3}$	$1.3 \times 10^{-2}$	$6.6 \times 10^{-4}$	$3.2 \times 10^{-3}$	$2.1 \times 10^{-3}$	$1.0 \times 10^{-2}$	$3.3 \times 10^{-3}$	$1.6 \times 10^{-2}$

<sup>a</sup> The world-average value is based on a world-average population density given in table 3 together with a world-average consumption rate for terrestrial foods (table 7).

<sup>b</sup> For <sup>3</sup>H the calculated doses include a contribution from HTO and OBT as discussed in section III.A.3.

<sup>c</sup> For these radionuclides the calculated doses include a contribution from the ingrowth of progeny (see appendix for details of the progeny included).

Table 27. Local and regional components of collective dose for discharges to atmosphere for inland nuclear sites

These collective doses are based on the population distributions out to 1,500 km for inland nuclear sites given in table 4 for the regions shown in figure II. They apply to inland nuclear sites only. Because there were no inland operating nuclear power plants in Africa or West Asia at the time of analysis, results are not given for these regions

Radionuclide	Collective doses integrated to 100 years from a year's continuous discharge at a rate of 1 Bq/s (manSv)									
	Asia and Pacific		Europe		Latin America		North America		World average <sup>a</sup>	
	Local	Regional	Local	Regional	Local	Regional	Local	Regional	Local	Regional
<sup>3</sup> H <sup>b</sup>	$1.2 \times 10^{-7}$	$3.3 \times 10^{-7}$	$3.4 \times 10^{-8}$	$1.6 \times 10^{-7}$	$2.8 \times 10^{-8}$	$2.4 \times 10^{-8}$	$2.2 \times 10^{-8}$	$6.7 \times 10^{-8}$	$2.9 \times 10^{-8}$	$1.1 \times 10^{-7}$
<sup>14</sup> C	$9.2 \times 10^{-6}$	$1.6 \times 10^{-5}$	$2.3 \times 10^{-6}$	$6.7 \times 10^{-6}$	$2.1 \times 10^{-6}$	$1.1 \times 10^{-6}$	$1.5 \times 10^{-6}$	$2.8 \times 10^{-6}$	$2.2 \times 10^{-6}$	$5.2 \times 10^{-6}$
<sup>35</sup> S	$2.0 \times 10^{-5}$	$3.1 \times 10^{-5}$	$9.4 \times 10^{-6}$	$2.5 \times 10^{-5}$	$8.1 \times 10^{-6}$	$4.0 \times 10^{-6}$	$8.1 \times 10^{-6}$	$1.5 \times 10^{-5}$	$6.3 \times 10^{-6}$	$1.4 \times 10^{-5}$
<sup>41</sup> Ar	$4.6 \times 10^{-9}$	$1.1 \times 10^{-14}$	$1.1 \times 10^{-9}$	$4.8 \times 10^{-15}$	$1.1 \times 10^{-9}$	$8.3 \times 10^{-16}$	$7.4 \times 10^{-10}$	$2.1 \times 10^{-15}$	$1.1 \times 10^{-9}$	$3.9 \times 10^{-15}$
<sup>54</sup> Mn	$3.3 \times 10^{-6}$	$5.4 \times 10^{-6}$	$1.0 \times 10^{-6}$	$2.9 \times 10^{-6}$	$8.4 \times 10^{-7}$	$4.3 \times 10^{-7}$	$7.0 \times 10^{-7}$	$1.3 \times 10^{-6}$	$8.4 \times 10^{-7}$	$1.9 \times 10^{-6}$
<sup>58</sup> Co	$7.8 \times 10^{-6}$	$1.2 \times 10^{-5}$	$2.7 \times 10^{-6}$	$7.3 \times 10^{-6}$	$2.3 \times 10^{-6}$	$1.2 \times 10^{-6}$	$2.0 \times 10^{-6}$	$3.6 \times 10^{-6}$	$2.1 \times 10^{-6}$	$4.7 \times 10^{-6}$
<sup>60</sup> Co	$2.8 \times 10^{-4}$	$4.6 \times 10^{-4}$	$1.1 \times 10^{-4}$	$3.1 \times 10^{-4}$	$1.0 \times 10^{-4}$	$5.2 \times 10^{-5}$	$9.2 \times 10^{-5}$	$1.7 \times 10^{-4}$	$8.4 \times 10^{-5}$	$1.9 \times 10^{-4}$
<sup>65</sup> Zn	$9.2 \times 10^{-5}$	$1.5 \times 10^{-4}$	$4.2 \times 10^{-5}$	$1.2 \times 10^{-4}$	$3.7 \times 10^{-5}$	$1.9 \times 10^{-5}$	$3.7 \times 10^{-5}$	$6.8 \times 10^{-5}$	$2.9 \times 10^{-5}$	$6.5 \times 10^{-5}$

Radionuclide	Collective doses integrated to 100 years from a year's continuous discharge at a rate of 1 Bq/s (manSv)									
	Asia and Pacific		Europe		Latin America		North America		World average <sup>a</sup>	
	Local	Regional	Local	Regional	Local	Regional	Local	Regional	Local	Regional
<sup>85</sup> Kr	$1.0 \times 10^{-10}$	$2.8 \times 10^{-10}$	$2.5 \times 10^{-11}$	$1.2 \times 10^{-10}$	$2.5 \times 10^{-11}$	$2.2 \times 10^{-11}$	$1.7 \times 10^{-11}$	$5.1 \times 10^{-11}$	$2.5 \times 10^{-11}$	$9.4 \times 10^{-11}$
<sup>90</sup> Sr <sup>c</sup>	$7.7 \times 10^{-4}$	$1.3 \times 10^{-3}$	$2.6 \times 10^{-4}$	$7.2 \times 10^{-4}$	$1.9 \times 10^{-4}$	$9.9 \times 10^{-5}$	$1.7 \times 10^{-4}$	$3.0 \times 10^{-4}$	$2.0 \times 10^{-4}$	$4.5 \times 10^{-4}$
<sup>106</sup> Ru <sup>c</sup>	$3.8 \times 10^{-5}$	$6.1 \times 10^{-5}$	$1.4 \times 10^{-5}$	$4.0 \times 10^{-5}$	$1.3 \times 10^{-5}$	$6.6 \times 10^{-6}$	$1.2 \times 10^{-5}$	$2.2 \times 10^{-5}$	$1.1 \times 10^{-5}$	$2.4 \times 10^{-5}$
<sup>129</sup> I	$1.4 \times 10^{-3}$	$2.2 \times 10^{-3}$	$3.8 \times 10^{-4}$	$1.1 \times 10^{-3}$	$3.1 \times 10^{-4}$	$1.6 \times 10^{-4}$	$2.4 \times 10^{-4}$	$4.3 \times 10^{-4}$	$3.3 \times 10^{-4}$	$7.5 \times 10^{-4}$
<sup>131</sup> I	$3.4 \times 10^{-5}$	$4.3 \times 10^{-5}$	$1.1 \times 10^{-5}$	$2.3 \times 10^{-5}$	$8.2 \times 10^{-6}$	$3.2 \times 10^{-6}$	$6.7 \times 10^{-6}$	$9.6 \times 10^{-6}$	$8.5 \times 10^{-6}$	$1.5 \times 10^{-5}$
<sup>133</sup> Xe	$1.2 \times 10^{-9}$	$2.2 \times 10^{-9}$	$3.0 \times 10^{-10}$	$9.1 \times 10^{-10}$	$2.9 \times 10^{-10}$	$1.7 \times 10^{-10}$	$1.9 \times 10^{-10}$	$4.0 \times 10^{-10}$	$2.9 \times 10^{-10}$	$7.4 \times 10^{-10}$
<sup>135</sup> Xe	$6.3 \times 10^{-9}$	$5.5 \times 10^{-10}$	$1.6 \times 10^{-9}$	$2.5 \times 10^{-10}$	$1.5 \times 10^{-9}$	$4.3 \times 10^{-11}$	$1.0 \times 10^{-9}$	$1.1 \times 10^{-10}$	$1.5 \times 10^{-9}$	$2.0 \times 10^{-10}$
<sup>138</sup> Xe <sup>c</sup>	$1.4 \times 10^{-11}$	$5.8 \times 10^{-31}$	$3.5 \times 10^{-12}$	$2.6 \times 10^{-31}$	$3.5 \times 10^{-12}$	$4.5 \times 10^{-32}$	$2.3 \times 10^{-12}$	$1.1 \times 10^{-31}$	$3.5 \times 10^{-12}$	$2.1 \times 10^{-31}$
<sup>134</sup> Cs	$2.6 \times 10^{-4}$	$4.3 \times 10^{-4}$	$8.4 \times 10^{-5}$	$2.3 \times 10^{-4}$	$7.4 \times 10^{-5}$	$3.8 \times 10^{-5}$	$6.2 \times 10^{-5}$	$1.1 \times 10^{-4}$	$6.9 \times 10^{-5}$	$1.6 \times 10^{-4}$
<sup>137</sup> Cs <sup>c</sup>	$3.0 \times 10^{-4}$	$4.9 \times 10^{-4}$	$9.1 \times 10^{-5}$	$2.5 \times 10^{-4}$	$8.2 \times 10^{-5}$	$4.2 \times 10^{-5}$	$6.5 \times 10^{-5}$	$1.2 \times 10^{-4}$	$7.8 \times 10^{-5}$	$1.8 \times 10^{-4}$
<sup>210</sup> Pb	$2.5 \times 10^{-3}$	$4.0 \times 10^{-3}$	$6.9 \times 10^{-4}$	$1.9 \times 10^{-3}$	$5.4 \times 10^{-4}$	$2.8 \times 10^{-4}$	$4.2 \times 10^{-4}$	$7.7 \times 10^{-4}$	$5.9 \times 10^{-4}$	$1.3 \times 10^{-3}$
<sup>210</sup> Po	$3.7 \times 10^{-3}$	$6.0 \times 10^{-3}$	$1.2 \times 10^{-3}$	$3.3 \times 10^{-3}$	$9.7 \times 10^{-4}$	$4.9 \times 10^{-4}$	$8.2 \times 10^{-4}$	$1.5 \times 10^{-3}$	$9.6 \times 10^{-4}$	$2.1 \times 10^{-3}$
<sup>222</sup> Rn <sup>c</sup>	$3.0 \times 10^{-6}$	$4.7 \times 10^{-6}$	$7.4 \times 10^{-7}$	$2.0 \times 10^{-6}$	$7.3 \times 10^{-7}$	$3.6 \times 10^{-7}$	$4.8 \times 10^{-7}$	$8.7 \times 10^{-7}$	$7.3 \times 10^{-7}$	$1.6 \times 10^{-6}$
<sup>226</sup> Ra	$3.6 \times 10^{-3}$	$5.8 \times 10^{-3}$	$9.7 \times 10^{-4}$	$2.7 \times 10^{-3}$	$7.9 \times 10^{-4}$	$4.1 \times 10^{-4}$	$5.9 \times 10^{-4}$	$1.1 \times 10^{-3}$	$8.5 \times 10^{-4}$	$1.9 \times 10^{-3}$
<sup>230</sup> Th	$4.4 \times 10^{-3}$	$7.1 \times 10^{-3}$	$1.1 \times 10^{-3}$	$3.0 \times 10^{-3}$	$1.0 \times 10^{-3}$	$5.4 \times 10^{-4}$	$7.1 \times 10^{-4}$	$1.3 \times 10^{-3}$	$1.1 \times 10^{-3}$	$2.4 \times 10^{-3}$
<sup>232</sup> Th <sup>c</sup>	$2.2 \times 10^{-2}$	$3.6 \times 10^{-2}$	$5.6 \times 10^{-3}$	$1.6 \times 10^{-2}$	$5.3 \times 10^{-3}$	$2.7 \times 10^{-3}$	$3.6 \times 10^{-3}$	$6.7 \times 10^{-3}$	$5.4 \times 10^{-3}$	$1.2 \times 10^{-2}$
<sup>234</sup> U	$1.2 \times 10^{-3}$	$1.9 \times 10^{-3}$	$3.1 \times 10^{-4}$	$8.6 \times 10^{-4}$	$2.9 \times 10^{-4}$	$1.5 \times 10^{-4}$	$2.1 \times 10^{-4}$	$3.8 \times 10^{-4}$	$3.0 \times 10^{-4}$	$6.7 \times 10^{-4}$
<sup>238</sup> U <sup>c</sup>	$1.0 \times 10^{-3}$	$1.7 \times 10^{-3}$	$2.7 \times 10^{-4}$	$7.4 \times 10^{-4}$	$2.5 \times 10^{-4}$	$1.3 \times 10^{-4}$	$1.8 \times 10^{-4}$	$3.3 \times 10^{-4}$	$2.5 \times 10^{-4}$	$5.7 \times 10^{-4}$
<sup>239</sup> Pu	$1.5 \times 10^{-2}$	$2.4 \times 10^{-2}$	$3.6 \times 10^{-3}$	$1.0 \times 10^{-2}$	$3.5 \times 10^{-3}$	$1.8 \times 10^{-3}$	$2.4 \times 10^{-3}$	$4.3 \times 10^{-3}$	$3.6 \times 10^{-3}$	$8.0 \times 10^{-3}$
<sup>240</sup> Pu	$1.5 \times 10^{-2}$	$2.4 \times 10^{-2}$	$3.6 \times 10^{-3}$	$1.0 \times 10^{-2}$	$3.5 \times 10^{-3}$	$1.8 \times 10^{-3}$	$2.4 \times 10^{-3}$	$4.3 \times 10^{-3}$	$3.6 \times 10^{-3}$	$8.0 \times 10^{-3}$
<sup>241</sup> Am	$1.2 \times 10^{-2}$	$2.0 \times 10^{-2}$	$3.0 \times 10^{-3}$	$8.4 \times 10^{-3}$	$3.0 \times 10^{-3}$	$1.5 \times 10^{-3}$	$2.0 \times 10^{-3}$	$3.6 \times 10^{-3}$	$3.0 \times 10^{-3}$	$6.8 \times 10^{-3}$

<sup>a</sup> The world-average value is based on a world average population density given in table 4 together with a world-average consumption rate for terrestrial foods (table 7).

<sup>b</sup> For <sup>3</sup>H the calculated doses include a contribution from HTO and OBT as discussed in section III.A.3.

<sup>c</sup> For these radionuclides the calculated doses include a contribution from the ingrowth of progeny (see appendix for details).

Table 28. Local and regional components of collective dose for discharges to atmosphere for coastal nuclear sites

These collective doses are based on the population distributions out to 1 500 km for coastal nuclear sites given in table 4 for the regions shown in figure II. They apply to coastal nuclear sites only. Because there were no coastal operating nuclear power plants in West Asia at the time of analysis, results are not given for this region

Radionuclide	Collective doses integrated to 100 years from a year's continuous discharge at a rate of 1 Bq/s (manSv)											
	Africa		Asia and Pacific		Europe		Latin America		North America		World average <sup>a</sup>	
	Local	Regional	Local	Regional	Local	Regional	Local	Regional	Local	Regional	Local	Regional
<sup>3</sup> H <sup>b</sup>	2.3 × 10 <sup>-8</sup>	6.9 × 10 <sup>-9</sup>	5.3 × 10 <sup>-8</sup>	1.6 × 10 <sup>-7</sup>	2.5 × 10 <sup>-8</sup>	1.2 × 10 <sup>-7</sup>	2.2 × 10 <sup>-8</sup>	6.1 × 10 <sup>-8</sup>	3.4 × 10 <sup>-8</sup>	6.3 × 10 <sup>-8</sup>	3.6 × 10 <sup>-8</sup>	1.1 × 10 <sup>-7</sup>
<sup>14</sup> C	1.7 × 10 <sup>-6</sup>	2.8 × 10 <sup>-7</sup>	4.1 × 10 <sup>-6</sup>	7.7 × 10 <sup>-6</sup>	1.6 × 10 <sup>-6</sup>	4.8 × 10 <sup>-6</sup>	1.6 × 10 <sup>-6</sup>	3.0 × 10 <sup>-6</sup>	2.3 × 10 <sup>-6</sup>	2.7 × 10 <sup>-6</sup>	2.7 × 10 <sup>-6</sup>	5.0 × 10 <sup>-6</sup>
<sup>35</sup> S	2.8 × 10 <sup>-6</sup>	4.3 × 10 <sup>-7</sup>	8.6 × 10 <sup>-6</sup>	1.5 × 10 <sup>-5</sup>	6.7 × 10 <sup>-6</sup>	1.8 × 10 <sup>-5</sup>	6.3 × 10 <sup>-6</sup>	1.1 × 10 <sup>-5</sup>	1.3 × 10 <sup>-5</sup>	1.4 × 10 <sup>-5</sup>	7.7 × 10 <sup>-6</sup>	1.4 × 10 <sup>-5</sup>
<sup>41</sup> Ar	9.6 × 10 <sup>-10</sup>	6.1 × 10 <sup>-17</sup>	2.0 × 10 <sup>-9</sup>	4.8 × 10 <sup>-15</sup>	8.1 × 10 <sup>-10</sup>	3.5 × 10 <sup>-15</sup>	8.7 × 10 <sup>-10</sup>	3.4 × 10 <sup>-15</sup>	1.2 × 10 <sup>-9</sup>	2.2 × 10 <sup>-15</sup>	1.4 × 10 <sup>-9</sup>	3.6 × 10 <sup>-15</sup>
<sup>54</sup> Mn	6.1 × 10 <sup>-7</sup>	9.7 × 10 <sup>-8</sup>	1.5 × 10 <sup>-6</sup>	2.6 × 10 <sup>-6</sup>	7.4 × 10 <sup>-7</sup>	2.1 × 10 <sup>-6</sup>	6.6 × 10 <sup>-7</sup>	1.2 × 10 <sup>-6</sup>	1.1 × 10 <sup>-6</sup>	1.2 × 10 <sup>-6</sup>	1.0 × 10 <sup>-6</sup>	1.8 × 10 <sup>-6</sup>
<sup>58</sup> Co	1.4 × 10 <sup>-6</sup>	2.2 × 10 <sup>-7</sup>	3.4 × 10 <sup>-6</sup>	5.9 × 10 <sup>-6</sup>	1.9 × 10 <sup>-6</sup>	5.3 × 10 <sup>-6</sup>	1.8 × 10 <sup>-6</sup>	3.2 × 10 <sup>-6</sup>	3.1 × 10 <sup>-6</sup>	3.4 × 10 <sup>-6</sup>	2.6 × 10 <sup>-6</sup>	4.5 × 10 <sup>-6</sup>
<sup>60</sup> Co	4.8 × 10 <sup>-5</sup>	7.7 × 10 <sup>-6</sup>	1.2 × 10 <sup>-4</sup>	2.2 × 10 <sup>-4</sup>	7.9 × 10 <sup>-5</sup>	2.2 × 10 <sup>-4</sup>	7.9 × 10 <sup>-5</sup>	1.4 × 10 <sup>-4</sup>	1.4 × 10 <sup>-4</sup>	1.6 × 10 <sup>-4</sup>	1.0 × 10 <sup>-4</sup>	1.8 × 10 <sup>-4</sup>
<sup>65</sup> Zn	1.3 × 10 <sup>-5</sup>	2.1 × 10 <sup>-6</sup>	4.0 × 10 <sup>-5</sup>	7.2 × 10 <sup>-5</sup>	3.0 × 10 <sup>-5</sup>	8.4 × 10 <sup>-5</sup>	2.9 × 10 <sup>-5</sup>	5.1 × 10 <sup>-5</sup>	5.8 × 10 <sup>-5</sup>	6.5 × 10 <sup>-5</sup>	3.6 × 10 <sup>-5</sup>	6.4 × 10 <sup>-5</sup>
<sup>85</sup> Kr	2.1 × 10 <sup>-11</sup>	6.5 × 10 <sup>-12</sup>	4.5 × 10 <sup>-11</sup>	1.4 × 10 <sup>-10</sup>	1.8 × 10 <sup>-11</sup>	8.5 × 10 <sup>-11</sup>	2.0 × 10 <sup>-11</sup>	5.5 × 10 <sup>-11</sup>	2.6 × 10 <sup>-11</sup>	4.8 × 10 <sup>-11</sup>	3.1 × 10 <sup>-11</sup>	9.3 × 10 <sup>-11</sup>
<sup>90</sup> Sr <sup>c</sup>	1.4 × 10 <sup>-4</sup>	2.2 × 10 <sup>-5</sup>	3.4 × 10 <sup>-4</sup>	6.1 × 10 <sup>-4</sup>	1.9 × 10 <sup>-4</sup>	5.2 × 10 <sup>-4</sup>	1.5 × 10 <sup>-4</sup>	2.7 × 10 <sup>-4</sup>	2.6 × 10 <sup>-4</sup>	2.9 × 10 <sup>-4</sup>	2.4 × 10 <sup>-4</sup>	4.4 × 10 <sup>-4</sup>
<sup>106</sup> Ru <sup>c</sup>	6.2 × 10 <sup>-6</sup>	9.9 × 10 <sup>-7</sup>	1.7 × 10 <sup>-5</sup>	3.0 × 10 <sup>-5</sup>	1.0 × 10 <sup>-5</sup>	2.9 × 10 <sup>-5</sup>	1.0 × 10 <sup>-5</sup>	1.8 × 10 <sup>-5</sup>	1.9 × 10 <sup>-5</sup>	2.1 × 10 <sup>-5</sup>	1.3 × 10 <sup>-5</sup>	2.4 × 10 <sup>-5</sup>
<sup>129</sup> I	2.5 × 10 <sup>-4</sup>	4.0 × 10 <sup>-5</sup>	6.1 × 10 <sup>-4</sup>	1.1 × 10 <sup>-3</sup>	2.7 × 10 <sup>-4</sup>	7.7 × 10 <sup>-4</sup>	2.4 × 10 <sup>-4</sup>	4.3 × 10 <sup>-4</sup>	3.7 × 10 <sup>-4</sup>	4.2 × 10 <sup>-4</sup>	4.0 × 10 <sup>-4</sup>	7.3 × 10 <sup>-4</sup>
<sup>131</sup> I	6.2 × 10 <sup>-6</sup>	6.4 × 10 <sup>-7</sup>	1.5 × 10 <sup>-5</sup>	2.0 × 10 <sup>-5</sup>	7.6 × 10 <sup>-6</sup>	1.7 × 10 <sup>-5</sup>	6.4 × 10 <sup>-6</sup>	9.4 × 10 <sup>-6</sup>	1.1 × 10 <sup>-5</sup>	9.4 × 10 <sup>-6</sup>	1.0 × 10 <sup>-5</sup>	1.4 × 10 <sup>-5</sup>
<sup>133</sup> Xe <sup>c</sup>	2.5 × 10 <sup>-10</sup>	3.8 × 10 <sup>-11</sup>	5.3 × 10 <sup>-10</sup>	1.0 × 10 <sup>-9</sup>	2.1 × 10 <sup>-10</sup>	6.6 × 10 <sup>-10</sup>	2.3 × 10 <sup>-10</sup>	4.7 × 10 <sup>-10</sup>	3.0 × 10 <sup>-10</sup>	3.8 × 10 <sup>-10</sup>	3.6 × 10 <sup>-10</sup>	7.1 × 10 <sup>-10</sup>
<sup>135</sup> Xe	1.3 × 10 <sup>-9</sup>	3.2 × 10 <sup>-12</sup>	2.8 × 10 <sup>-9</sup>	2.5 × 10 <sup>-10</sup>	1.1 × 10 <sup>-9</sup>	1.8 × 10 <sup>-10</sup>	1.2 × 10 <sup>-9</sup>	1.7 × 10 <sup>-10</sup>	1.6 × 10 <sup>-9</sup>	1.1 × 10 <sup>-10</sup>	1.9 × 10 <sup>-9</sup>	1.8 × 10 <sup>-10</sup>
<sup>138</sup> Xe <sup>c</sup>	3.0 × 10 <sup>-12</sup>	3.3 × 10 <sup>-33</sup>	6.3 × 10 <sup>-12</sup>	2.6 × 10 <sup>-31</sup>	2.5 × 10 <sup>-12</sup>	1.9 × 10 <sup>-31</sup>	2.7 × 10 <sup>-12</sup>	1.8 × 10 <sup>-31</sup>	3.6 × 10 <sup>-12</sup>	1.2 × 10 <sup>-31</sup>	4.2 × 10 <sup>-12</sup>	1.9 × 10 <sup>-31</sup>
<sup>134</sup> Cs	4.6 × 10 <sup>-5</sup>	7.4 × 10 <sup>-6</sup>	1.2 × 10 <sup>-4</sup>	2.1 × 10 <sup>-4</sup>	6.0 × 10 <sup>-5</sup>	1.7 × 10 <sup>-4</sup>	5.8 × 10 <sup>-5</sup>	1.0 × 10 <sup>-4</sup>	9.7 × 10 <sup>-5</sup>	1.1 × 10 <sup>-4</sup>	8.4 × 10 <sup>-5</sup>	1.5 × 10 <sup>-4</sup>
<sup>137</sup> Cs <sup>c</sup>	5.5 × 10 <sup>-5</sup>	8.9 × 10 <sup>-6</sup>	1.3 × 10 <sup>-4</sup>	2.4 × 10 <sup>-4</sup>	6.5 × 10 <sup>-5</sup>	1.8 × 10 <sup>-4</sup>	6.4 × 10 <sup>-5</sup>	1.1 × 10 <sup>-4</sup>	1.0 × 10 <sup>-4</sup>	1.2 × 10 <sup>-4</sup>	9.5 × 10 <sup>-5</sup>	1.7 × 10 <sup>-4</sup>
<sup>210</sup> Pb	4.7 × 10 <sup>-4</sup>	7.6 × 10 <sup>-5</sup>	1.1 × 10 <sup>-3</sup>	2.0 × 10 <sup>-3</sup>	4.9 × 10 <sup>-4</sup>	1.4 × 10 <sup>-3</sup>	4.2 × 10 <sup>-4</sup>	7.5 × 10 <sup>-4</sup>	6.6 × 10 <sup>-4</sup>	7.4 × 10 <sup>-4</sup>	7.2 × 10 <sup>-4</sup>	1.3 × 10 <sup>-3</sup>
<sup>210</sup> Po	6.9 × 10 <sup>-4</sup>	1.1 × 10 <sup>-4</sup>	1.6 × 10 <sup>-3</sup>	2.9 × 10 <sup>-3</sup>	8.7 × 10 <sup>-4</sup>	2.4 × 10 <sup>-3</sup>	7.6 × 10 <sup>-4</sup>	1.3 × 10 <sup>-3</sup>	1.3 × 10 <sup>-3</sup>	1.4 × 10 <sup>-3</sup>	1.2 × 10 <sup>-3</sup>	2.1 × 10 <sup>-3</sup>
<sup>222</sup> Rn <sup>c</sup>	6.2 × 10 <sup>-7</sup>	7.5 × 10 <sup>-8</sup>	1.3 × 10 <sup>-6</sup>	2.2 × 10 <sup>-6</sup>	5.3 × 10 <sup>-7</sup>	1.4 × 10 <sup>-6</sup>	5.7 × 10 <sup>-7</sup>	1.1 × 10 <sup>-6</sup>	7.6 × 10 <sup>-7</sup>	8.5 × 10 <sup>-7</sup>	8.9 × 10 <sup>-7</sup>	1.5 × 10 <sup>-6</sup>
<sup>226</sup> Ra	6.8 × 10 <sup>-4</sup>	1.1 × 10 <sup>-4</sup>	1.6 × 10 <sup>-3</sup>	2.8 × 10 <sup>-3</sup>	6.9 × 10 <sup>-4</sup>	1.9 × 10 <sup>-3</sup>	6.2 × 10 <sup>-4</sup>	1.1 × 10 <sup>-3</sup>	9.3 × 10 <sup>-4</sup>	1.0 × 10 <sup>-3</sup>	1.0 × 10 <sup>-3</sup>	1.9 × 10 <sup>-3</sup>

Radionuclide	Collective doses integrated to 100 years from a year's continuous discharge at a rate of 1 Bq/s (manSv)											
	Africa		Asia and Pacific		Europe		Latin America		North America		World average <sup>a</sup>	
	Local	Regional	Local	Regional	Local	Regional	Local	Regional	Local	Regional	Local	Regional
<sup>230</sup> Th	$9.0 \times 10^{-4}$	$1.5 \times 10^{-4}$	$1.9 \times 10^{-3}$	$3.5 \times 10^{-3}$	$7.8 \times 10^{-4}$	$2.2 \times 10^{-3}$	$8.2 \times 10^{-4}$	$1.5 \times 10^{-3}$	$1.1 \times 10^{-3}$	$1.2 \times 10^{-3}$	$1.3 \times 10^{-3}$	$2.3 \times 10^{-3}$
<sup>232</sup> Th <sup>c</sup>	$4.6 \times 10^{-3}$	$7.3 \times 10^{-4}$	$9.8 \times 10^{-3}$	$1.8 \times 10^{-2}$	$4.0 \times 10^{-3}$	$1.1 \times 10^{-2}$	$4.2 \times 10^{-3}$	$7.4 \times 10^{-3}$	$5.7 \times 10^{-3}$	$6.4 \times 10^{-3}$	$6.6 \times 10^{-3}$	$1.2 \times 10^{-2}$
<sup>234</sup> U	$2.4 \times 10^{-4}$	$3.9 \times 10^{-5}$	$5.3 \times 10^{-4}$	$9.5 \times 10^{-4}$	$2.2 \times 10^{-4}$	$6.3 \times 10^{-4}$	$2.3 \times 10^{-4}$	$4.1 \times 10^{-4}$	$3.2 \times 10^{-4}$	$3.7 \times 10^{-4}$	$3.6 \times 10^{-4}$	$6.5 \times 10^{-4}$
<sup>238</sup> U <sup>c</sup>	$2.1 \times 10^{-4}$	$3.3 \times 10^{-5}$	$4.5 \times 10^{-4}$	$8.1 \times 10^{-4}$	$1.9 \times 10^{-4}$	$5.3 \times 10^{-4}$	$2.0 \times 10^{-4}$	$3.5 \times 10^{-4}$	$2.8 \times 10^{-4}$	$3.1 \times 10^{-4}$	$3.1 \times 10^{-4}$	$5.5 \times 10^{-4}$
<sup>239</sup> Pu	$3.0 \times 10^{-3}$	$4.9 \times 10^{-4}$	$6.4 \times 10^{-3}$	$1.2 \times 10^{-2}$	$2.6 \times 10^{-3}$	$7.3 \times 10^{-3}$	$2.8 \times 10^{-3}$	$4.9 \times 10^{-3}$	$3.7 \times 10^{-3}$	$4.2 \times 10^{-3}$	$4.3 \times 10^{-3}$	$7.9 \times 10^{-3}$
<sup>240</sup> Pu	$3.0 \times 10^{-3}$	$4.9 \times 10^{-4}$	$6.4 \times 10^{-3}$	$1.2 \times 10^{-2}$	$2.6 \times 10^{-3}$	$7.3 \times 10^{-3}$	$2.8 \times 10^{-3}$	$4.9 \times 10^{-3}$	$3.7 \times 10^{-3}$	$4.2 \times 10^{-3}$	$4.3 \times 10^{-3}$	$7.9 \times 10^{-3}$
<sup>241</sup> Am	$2.5 \times 10^{-3}$	$4.1 \times 10^{-4}$	$5.4 \times 10^{-3}$	$9.7 \times 10^{-3}$	$2.2 \times 10^{-3}$	$6.1 \times 10^{-3}$	$2.3 \times 10^{-3}$	$4.1 \times 10^{-3}$	$3.1 \times 10^{-3}$	$3.5 \times 10^{-3}$	$3.6 \times 10^{-3}$	$6.6 \times 10^{-3}$

<sup>a</sup> The world-average value is based on a world average population density given in table 3 together with a world-average consumption rate for terrestrial foods (table 7).

<sup>b</sup> For <sup>3</sup>H the calculated doses include a contribution from HTO and OBT as discussed in section III.A.3.

<sup>c</sup> For these radionuclides the calculated doses include a contribution from the ingrowth of progeny (see appendix for details).

Table 29. Local and regional components of collective dose for discharges to atmosphere for low population density sites

These collective dose estimates are for locations with a low population density out to 1,500 km and are based on a population density of 5 km<sup>-2</sup>. They apply to the world as a whole and are intended for use for uranium mines and mill tailings sites

Radionuclide	Collective dose integrated to 100 years from a year's continuous discharge at a rate of 1 Bq/s (man Sv)	
	Local component	Regional component
<sup>3</sup> H <sup>a</sup>	1.0 × 10 <sup>-9</sup>	8.4 × 10 <sup>-9</sup>
<sup>14</sup> C	7.5 × 10 <sup>-8</sup>	3.8 × 10 <sup>-7</sup>
<sup>35</sup> S	2.2 × 10 <sup>-7</sup>	1.0 × 10 <sup>-6</sup>
<sup>41</sup> Ar	3.8 × 10 <sup>-11</sup>	2.0 × 10 <sup>-16</sup>
<sup>54</sup> Mn	2.9 × 10 <sup>-8</sup>	1.4 × 10 <sup>-7</sup>
<sup>58</sup> Co	7.3 × 10 <sup>-8</sup>	3.4 × 10 <sup>-7</sup>
<sup>60</sup> Co	2.9 × 10 <sup>-6</sup>	1.4 × 10 <sup>-5</sup>
<sup>65</sup> Zn	1.0 × 10 <sup>-6</sup>	4.7 × 10 <sup>-6</sup>
<sup>85</sup> Kr	8.6 × 10 <sup>-13</sup>	7.2 × 10 <sup>-12</sup>
<sup>90</sup> Sr <sup>b</sup>	6.8 × 10 <sup>-6</sup>	3.2 × 10 <sup>-5</sup>
<sup>106</sup> Ru <sup>b</sup>	3.7 × 10 <sup>-7</sup>	1.8 × 10 <sup>-6</sup>
<sup>129</sup> I	1.1 × 10 <sup>-5</sup>	5.4 × 10 <sup>-5</sup>
<sup>131</sup> I	2.9 × 10 <sup>-7</sup>	1.0 × 10 <sup>-6</sup>
<sup>133</sup> Xe <sup>b</sup>	1.0 × 10 <sup>-11</sup>	5.1 × 10 <sup>-11</sup>
<sup>135</sup> Xe	5.3 × 10 <sup>-11</sup>	1.1 × 10 <sup>-11</sup>
<sup>138</sup> Xe <sup>b</sup>	1.2 × 10 <sup>-13</sup>	1.1 × 10 <sup>-32</sup>
<sup>134</sup> Cs	2.4 × 10 <sup>-6</sup>	1.1 × 10 <sup>-5</sup>
<sup>137</sup> Cs <sup>b</sup>	2.7 × 10 <sup>-6</sup>	1.3 × 10 <sup>-5</sup>
<sup>210</sup> Pb	2.0 × 10 <sup>-5</sup>	9.6 × 10 <sup>-5</sup>
<sup>210</sup> Po	3.3 × 10 <sup>-5</sup>	1.5 × 10 <sup>-4</sup>
<sup>222</sup> Rn <sup>b</sup>	2.5 × 10 <sup>-8</sup>	1.1 × 10 <sup>-7</sup>
<sup>226</sup> Ra	2.9 × 10 <sup>-5</sup>	1.4 × 10 <sup>-4</sup>
<sup>230</sup> Th	3.6 × 10 <sup>-5</sup>	1.7 × 10 <sup>-4</sup>
<sup>232</sup> Th <sup>b</sup>	1.9 × 10 <sup>-4</sup>	8.9 × 10 <sup>-4</sup>
<sup>234</sup> U	1.0 × 10 <sup>-5</sup>	4.8 × 10 <sup>-5</sup>
<sup>238</sup> U <sup>b</sup>	8.6 × 10 <sup>-6</sup>	4.1 × 10 <sup>-5</sup>
<sup>239</sup> Pu	1.2 × 10 <sup>-4</sup>	5.8 × 10 <sup>-4</sup>
<sup>240</sup> Pu	1.2 × 10 <sup>-4</sup>	5.8 × 10 <sup>-4</sup>
<sup>241</sup> Am	1.0 × 10 <sup>-4</sup>	4.9 × 10 <sup>-4</sup>

<sup>a</sup> For <sup>3</sup>H the calculated doses include a contribution from HTO and OBT as discussed in section III.A.3.

<sup>b</sup> For these radionuclides the calculated doses include a contribution from the ingrowth of progeny (see appendix for details).

Table 30. Collective dose for discharges to small and large rivers

Values are for small and large rivers situated in the regions shown in figure II. The results for large rivers are also assumed to apply for lakes

Radio-nuclide	Collective doses integrated to 100 years from a year's continuous discharge at a rate of 1 Bq/s (man Sv)													
	Africa		Asia and Pacific		Europe		Latin America		North America		West Asia		World average <sup>a</sup>	
	Small	Large	Small	Large	Small	Large	Small	Large	Small	Large	Small	Large	Small	Large
<sup>3</sup> H <sup>b</sup>	1.9 × 10 <sup>-7</sup>	1.9 × 10 <sup>-7</sup>	1.9 × 10 <sup>-7</sup>	1.9 × 10 <sup>-7</sup>	1.9 × 10 <sup>-7</sup>	1.9 × 10 <sup>-7</sup>	1.9 × 10 <sup>-7</sup>	1.9 × 10 <sup>-7</sup>	1.9 × 10 <sup>-7</sup>	1.9 × 10 <sup>-7</sup>	1.9 × 10 <sup>-7</sup>	1.9 × 10 <sup>-7</sup>	1.9 × 10 <sup>-7</sup>	1.9 × 10 <sup>-7</sup>
<sup>14</sup> C	2.3 × 10 <sup>-3</sup>	1.2 × 10 <sup>-3</sup>	2.3 × 10 <sup>-3</sup>	1.2 × 10 <sup>-3</sup>	2.3 × 10 <sup>-3</sup>	1.2 × 10 <sup>-3</sup>	2.3 × 10 <sup>-3</sup>	1.2 × 10 <sup>-3</sup>	2.3 × 10 <sup>-3</sup>	1.2 × 10 <sup>-3</sup>	2.3 × 10 <sup>-3</sup>	1.4 × 10 <sup>-3</sup>	2.3 × 10 <sup>-3</sup>	1.2 × 10 <sup>-3</sup>
<sup>35</sup> S	7.4 × 10 <sup>-6</sup>	4.5 × 10 <sup>-6</sup>	7.4 × 10 <sup>-6</sup>	4.8 × 10 <sup>-6</sup>	7.4 × 10 <sup>-6</sup>	4.6 × 10 <sup>-6</sup>	7.4 × 10 <sup>-6</sup>	4.3 × 10 <sup>-6</sup>	7.4 × 10 <sup>-6</sup>	5.2 × 10 <sup>-6</sup>	7.4 × 10 <sup>-6</sup>	1.7 × 10 <sup>-5</sup>	7.4 × 10 <sup>-6</sup>	4.8 × 10 <sup>-6</sup>
<sup>54</sup> Mn	1.5 × 10 <sup>-6</sup>	9.2 × 10 <sup>-7</sup>	1.5 × 10 <sup>-6</sup>	9.8 × 10 <sup>-7</sup>	1.5 × 10 <sup>-6</sup>	9.4 × 10 <sup>-7</sup>	1.5 × 10 <sup>-6</sup>	8.8 × 10 <sup>-7</sup>	1.5 × 10 <sup>-6</sup>	1.1 × 10 <sup>-6</sup>	1.5 × 10 <sup>-6</sup>	3.6 × 10 <sup>-6</sup>	1.5 × 10 <sup>-6</sup>	9.7 × 10 <sup>-7</sup>
<sup>58</sup> Co	1.6 × 10 <sup>-6</sup>	1.3 × 10 <sup>-6</sup>	1.6 × 10 <sup>-6</sup>	1.4 × 10 <sup>-6</sup>	1.6 × 10 <sup>-6</sup>	1.3 × 10 <sup>-6</sup>	1.6 × 10 <sup>-6</sup>	1.3 × 10 <sup>-6</sup>	1.6 × 10 <sup>-6</sup>	1.4 × 10 <sup>-6</sup>	1.6 × 10 <sup>-6</sup>	3.1 × 10 <sup>-6</sup>	1.6 × 10 <sup>-6</sup>	1.4 × 10 <sup>-6</sup>
<sup>60</sup> Co	7.2 × 10 <sup>-6</sup>	6.4 × 10 <sup>-6</sup>	7.2 × 10 <sup>-6</sup>	6.8 × 10 <sup>-6</sup>	7.2 × 10 <sup>-6</sup>	6.5 × 10 <sup>-6</sup>	7.2 × 10 <sup>-6</sup>	6.1 × 10 <sup>-6</sup>	7.2 × 10 <sup>-6</sup>	7.2 × 10 <sup>-6</sup>	7.2 × 10 <sup>-6</sup>	2.2 × 10 <sup>-5</sup>	7.2 × 10 <sup>-6</sup>	6.7 × 10 <sup>-6</sup>
<sup>65</sup> Zn	1.4 × 10 <sup>-4</sup>	6.1 × 10 <sup>-5</sup>	1.4 × 10 <sup>-4</sup>	6.1 × 10 <sup>-5</sup>	1.4 × 10 <sup>-4</sup>	6.1 × 10 <sup>-5</sup>	1.4 × 10 <sup>-4</sup>	6.0 × 10 <sup>-5</sup>	1.4 × 10 <sup>-4</sup>	6.2 × 10 <sup>-5</sup>	1.4 × 10 <sup>-4</sup>	9.2 × 10 <sup>-5</sup>	1.4 × 10 <sup>-4</sup>	6.1 × 10 <sup>-5</sup>
<sup>90</sup> Sr <sup>c</sup>	7.2 × 10 <sup>-5</sup>	1.0 × 10 <sup>-4</sup>	7.2 × 10 <sup>-5</sup>	1.2 × 10 <sup>-4</sup>	7.2 × 10 <sup>-5</sup>	1.1 × 10 <sup>-4</sup>	7.2 × 10 <sup>-5</sup>	8.8 × 10 <sup>-5</sup>	7.2 × 10 <sup>-5</sup>	1.4 × 10 <sup>-4</sup>	7.2 × 10 <sup>-5</sup>	9.8 × 10 <sup>-4</sup>	7.2 × 10 <sup>-5</sup>	1.2 × 10 <sup>-4</sup>
<sup>106</sup> Ru <sup>c</sup>	1.4 × 10 <sup>-5</sup>	1.2 × 10 <sup>-5</sup>	1.4 × 10 <sup>-5</sup>	1.2 × 10 <sup>-5</sup>	1.4 × 10 <sup>-5</sup>	1.2 × 10 <sup>-5</sup>	1.4 × 10 <sup>-5</sup>	1.2 × 10 <sup>-5</sup>	1.4 × 10 <sup>-5</sup>	1.2 × 10 <sup>-5</sup>	1.4 × 10 <sup>-5</sup>	1.5 × 10 <sup>-5</sup>	1.4 × 10 <sup>-5</sup>	1.2 × 10 <sup>-5</sup>
<sup>129</sup> I	3.1 × 10 <sup>-4</sup>	3.8 × 10 <sup>-4</sup>	3.1 × 10 <sup>-4</sup>	4.5 × 10 <sup>-4</sup>	3.1 × 10 <sup>-4</sup>	4.0 × 10 <sup>-4</sup>	3.1 × 10 <sup>-4</sup>	3.4 × 10 <sup>-4</sup>	3.1 × 10 <sup>-4</sup>	5.3 × 10 <sup>-4</sup>	3.1 × 10 <sup>-4</sup>	3.3 × 10 <sup>-3</sup>	3.1 × 10 <sup>-4</sup>	4.4 × 10 <sup>-4</sup>
<sup>131</sup> I	5.7 × 10 <sup>-6</sup>	5.3 × 10 <sup>-6</sup>	5.7 × 10 <sup>-6</sup>	5.4 × 10 <sup>-6</sup>	5.7 × 10 <sup>-6</sup>	5.4 × 10 <sup>-6</sup>	5.7 × 10 <sup>-6</sup>	5.3 × 10 <sup>-6</sup>	5.7 × 10 <sup>-6</sup>	5.5 × 10 <sup>-6</sup>	5.7 × 10 <sup>-6</sup>	9.1 × 10 <sup>-6</sup>	5.7 × 10 <sup>-6</sup>	5.4 × 10 <sup>-6</sup>
<sup>134</sup> Cs	3.5 × 10 <sup>-4</sup>	7.8 × 10 <sup>-5</sup>	3.5 × 10 <sup>-4</sup>	8.7 × 10 <sup>-5</sup>	3.5 × 10 <sup>-4</sup>	8.1 × 10 <sup>-5</sup>	3.5 × 10 <sup>-4</sup>	7.1 × 10 <sup>-5</sup>	3.5 × 10 <sup>-4</sup>	9.8 × 10 <sup>-5</sup>	3.5 × 10 <sup>-4</sup>	4.9 × 10 <sup>-4</sup>	3.5 × 10 <sup>-4</sup>	8.5 × 10 <sup>-5</sup>
<sup>137</sup> Cs <sup>c</sup>	2.4 × 10 <sup>-4</sup>	5.5 × 10 <sup>-5</sup>	2.4 × 10 <sup>-4</sup>	6.3 × 10 <sup>-5</sup>	2.4 × 10 <sup>-4</sup>	5.7 × 10 <sup>-5</sup>	2.4 × 10 <sup>-4</sup>	5.0 × 10 <sup>-5</sup>	2.4 × 10 <sup>-4</sup>	7.2 × 10 <sup>-5</sup>	2.4 × 10 <sup>-4</sup>	3.9 × 10 <sup>-4</sup>	2.4 × 10 <sup>-4</sup>	6.1 × 10 <sup>-5</sup>
<sup>210</sup> Pb	1.3 × 10 <sup>-3</sup>	1.2 × 10 <sup>-3</sup>	1.3 × 10 <sup>-3</sup>	1.3 × 10 <sup>-3</sup>	1.3 × 10 <sup>-3</sup>	1.2 × 10 <sup>-3</sup>	1.3 × 10 <sup>-3</sup>	1.2 × 10 <sup>-3</sup>	1.3 × 10 <sup>-3</sup>	1.3 × 10 <sup>-3</sup>	1.3 × 10 <sup>-3</sup>	2.5 × 10 <sup>-3</sup>	1.3 × 10 <sup>-3</sup>	1.3 × 10 <sup>-3</sup>
<sup>210</sup> Po	2.3 × 10 <sup>-3</sup>	2.1 × 10 <sup>-3</sup>	2.3 × 10 <sup>-3</sup>	2.1 × 10 <sup>-3</sup>	2.3 × 10 <sup>-3</sup>	2.1 × 10 <sup>-3</sup>	2.3 × 10 <sup>-3</sup>	2.1 × 10 <sup>-3</sup>	2.3 × 10 <sup>-3</sup>	2.1 × 10 <sup>-3</sup>	2.3 × 10 <sup>-3</sup>	2.3 × 10 <sup>-3</sup>	2.3 × 10 <sup>-3</sup>	2.1 × 10 <sup>-3</sup>
<sup>226</sup> Ra	4.9 × 10 <sup>-4</sup>	5.9 × 10 <sup>-4</sup>	4.9 × 10 <sup>-4</sup>	6.6 × 10 <sup>-4</sup>	4.9 × 10 <sup>-4</sup>	6.1 × 10 <sup>-4</sup>	4.9 × 10 <sup>-4</sup>	5.4 × 10 <sup>-4</sup>	4.9 × 10 <sup>-4</sup>	7.5 × 10 <sup>-4</sup>	4.9 × 10 <sup>-4</sup>	3.8 × 10 <sup>-3</sup>	4.9 × 10 <sup>-4</sup>	6.5 × 10 <sup>-4</sup>
<sup>230</sup> Th	2.0 × 10 <sup>-4</sup>	2.0 × 10 <sup>-4</sup>	2.0 × 10 <sup>-4</sup>	2.0 × 10 <sup>-4</sup>	2.0 × 10 <sup>-4</sup>	2.0 × 10 <sup>-4</sup>	2.0 × 10 <sup>-4</sup>	2.0 × 10 <sup>-4</sup>	2.0 × 10 <sup>-4</sup>	2.0 × 10 <sup>-4</sup>	2.0 × 10 <sup>-4</sup>	2.7 × 10 <sup>-4</sup>	2.0 × 10 <sup>-4</sup>	2.0 × 10 <sup>-4</sup>
<sup>232</sup> Th <sup>c</sup>	1.5 × 10 <sup>-3</sup>	1.6 × 10 <sup>-3</sup>	1.5 × 10 <sup>-3</sup>	1.6 × 10 <sup>-3</sup>	1.5 × 10 <sup>-3</sup>	1.6 × 10 <sup>-3</sup>	1.5 × 10 <sup>-3</sup>	1.5 × 10 <sup>-3</sup>	1.5 × 10 <sup>-3</sup>	1.7 × 10 <sup>-3</sup>	1.5 × 10 <sup>-3</sup>	4.3 × 10 <sup>-3</sup>	1.5 × 10 <sup>-3</sup>	1.6 × 10 <sup>-3</sup>
<sup>234</sup> U	4.7 × 10 <sup>-5</sup>	5.1 × 10 <sup>-5</sup>	4.7 × 10 <sup>-5</sup>	5.3 × 10 <sup>-5</sup>	4.7 × 10 <sup>-5</sup>	5.1 × 10 <sup>-5</sup>	4.7 × 10 <sup>-5</sup>	4.9 × 10 <sup>-5</sup>	4.7 × 10 <sup>-5</sup>	5.7 × 10 <sup>-5</sup>	4.7 × 10 <sup>-5</sup>	1.7 × 10 <sup>-4</sup>	4.7 × 10 <sup>-5</sup>	5.3 × 10 <sup>-5</sup>
<sup>238</sup> U <sup>c</sup>	4.6 × 10 <sup>-5</sup>	5.0 × 10 <sup>-5</sup>	4.6 × 10 <sup>-5</sup>	5.2 × 10 <sup>-5</sup>	4.6 × 10 <sup>-5</sup>	5.1 × 10 <sup>-5</sup>	4.6 × 10 <sup>-5</sup>	4.8 × 10 <sup>-5</sup>	4.6 × 10 <sup>-5</sup>	5.5 × 10 <sup>-5</sup>	4.6 × 10 <sup>-5</sup>	1.6 × 10 <sup>-4</sup>	4.6 × 10 <sup>-5</sup>	5.2 × 10 <sup>-5</sup>
<sup>239</sup> Pu	2.3 × 10 <sup>-4</sup>	2.2 × 10 <sup>-4</sup>	2.3 × 10 <sup>-4</sup>	2.2 × 10 <sup>-4</sup>	2.3 × 10 <sup>-4</sup>	2.2 × 10 <sup>-4</sup>	2.3 × 10 <sup>-4</sup>	2.2 × 10 <sup>-4</sup>	2.3 × 10 <sup>-4</sup>	2.2 × 10 <sup>-4</sup>	2.3 × 10 <sup>-4</sup>	3.3 × 10 <sup>-4</sup>	2.3 × 10 <sup>-4</sup>	2.2 × 10 <sup>-4</sup>
<sup>240</sup> Pu	2.3 × 10 <sup>-4</sup>	2.2 × 10 <sup>-4</sup>	2.3 × 10 <sup>-4</sup>	2.2 × 10 <sup>-4</sup>	2.3 × 10 <sup>-4</sup>	2.2 × 10 <sup>-4</sup>	2.3 × 10 <sup>-4</sup>	2.2 × 10 <sup>-4</sup>	2.3 × 10 <sup>-4</sup>	2.2 × 10 <sup>-4</sup>	2.3 × 10 <sup>-4</sup>	3.3 × 10 <sup>-4</sup>	2.3 × 10 <sup>-4</sup>	2.2 × 10 <sup>-4</sup>
<sup>241</sup> Am	3.1 × 10 <sup>-4</sup>	1.8 × 10 <sup>-4</sup>	3.1 × 10 <sup>-4</sup>	1.8 × 10 <sup>-4</sup>	3.1 × 10 <sup>-4</sup>	1.8 × 10 <sup>-4</sup>	3.1 × 10 <sup>-4</sup>	1.8 × 10 <sup>-4</sup>	3.1 × 10 <sup>-4</sup>	1.9 × 10 <sup>-4</sup>	3.1 × 10 <sup>-4</sup>	3.1 × 10 <sup>-4</sup>	3.1 × 10 <sup>-4</sup>	1.8 × 10 <sup>-4</sup>

<sup>a</sup> The world-average collective dose is calculated using world-average values for irrigation (tables 11, 12 and 17) (note that the catch data for unit river length is the same for all regions and the world-average).<sup>b</sup> For <sup>3</sup>H the calculated doses include a contribution from HTO and OBT as discussed in section III.A.3.<sup>c</sup> For these radionuclides the calculated doses include a contribution from the ingrowth of progeny (see appendix for details).



Table 31. Local and regional components of collective dose for discharges to a marine environment

These results are for discharges to a marine environment for the regions shown in figure II

Radio-nuclide	Collective dose integrated to 100 years from a year's continuous discharge at a rate of 1 Bq/s (man Sv)													
	Africa		Asia and Pacific		Europe		Latin America		North America		West Asia		World average <sup>a</sup>	
	Local	Regional	Local	Regional	Local	Regional	Local	Regional	Local	Regional	Local	Regional	Local	Regional
<sup>3</sup> H	8.5 × 10 <sup>-13</sup>	4.8 × 10 <sup>-14</sup>	3.4 × 10 <sup>-12</sup>	5.8 × 10 <sup>-14</sup>	6.0 × 10 <sup>-13</sup>	4.7 × 10 <sup>-14</sup>	1.4 × 10 <sup>-12</sup>	2.8 × 10 <sup>-14</sup>	1.1 × 10 <sup>-12</sup>	1.8 × 10 <sup>-14</sup>	1.0 × 10 <sup>-12</sup>	5.7 × 10 <sup>-14</sup>	2.2 × 10 <sup>-12</sup>	3.1 × 10 <sup>-14</sup>
<sup>14</sup> C	5.5 × 10 <sup>-7</sup>	3.3 × 10 <sup>-8</sup>	2.2 × 10 <sup>-6</sup>	4.0 × 10 <sup>-8</sup>	3.9 × 10 <sup>-7</sup>	3.2 × 10 <sup>-8</sup>	9.2 × 10 <sup>-7</sup>	1.9 × 10 <sup>-8</sup>	6.9 × 10 <sup>-7</sup>	1.2 × 10 <sup>-8</sup>	6.5 × 10 <sup>-7</sup>	3.9 × 10 <sup>-8</sup>	1.4 × 10 <sup>-6</sup>	2.1 × 10 <sup>-8</sup>
<sup>35</sup> S	4.9 × 10 <sup>-11</sup>	5.0 × 10 <sup>-13</sup>	2.7 × 10 <sup>-10</sup>	6.6 × 10 <sup>-13</sup>	3.9 × 10 <sup>-11</sup>	4.9 × 10 <sup>-13</sup>	9.7 × 10 <sup>-11</sup>	3.0 × 10 <sup>-13</sup>	6.3 × 10 <sup>-11</sup>	2.0 × 10 <sup>-13</sup>	5.4 × 10 <sup>-11</sup>	5.9 × 10 <sup>-13</sup>	1.8 × 10 <sup>-10</sup>	3.6 × 10 <sup>-13</sup>
<sup>54</sup> Mn	5.1 × 10 <sup>-7</sup>	1.5 × 10 <sup>-9</sup>	3.9 × 10 <sup>-6</sup>	5.2 × 10 <sup>-9</sup>	4.5 × 10 <sup>-7</sup>	1.4 × 10 <sup>-9</sup>	1.2 × 10 <sup>-6</sup>	1.8 × 10 <sup>-9</sup>	7.2 × 10 <sup>-7</sup>	1.1 × 10 <sup>-9</sup>	5.1 × 10 <sup>-7</sup>	1.7 × 10 <sup>-9</sup>	2.6 × 10 <sup>-6</sup>	3.3 × 10 <sup>-9</sup>
<sup>58</sup> Co	2.5 × 10 <sup>-7</sup>	3.7 × 10 <sup>-10</sup>	1.6 × 10 <sup>-6</sup>	9.9 × 10 <sup>-10</sup>	1.9 × 10 <sup>-7</sup>	3.4 × 10 <sup>-10</sup>	5.8 × 10 <sup>-7</sup>	3.9 × 10 <sup>-10</sup>	3.8 × 10 <sup>-7</sup>	2.5 × 10 <sup>-10</sup>	2.8 × 10 <sup>-7</sup>	4.2 × 10 <sup>-10</sup>	1.1 × 10 <sup>-6</sup>	6.1 × 10 <sup>-10</sup>
<sup>60</sup> Co	1.4 × 10 <sup>-6</sup>	7.6 × 10 <sup>-9</sup>	8.8 × 10 <sup>-6</sup>	2.0 × 10 <sup>-8</sup>	1.0 × 10 <sup>-6</sup>	7.0 × 10 <sup>-9</sup>	3.1 × 10 <sup>-6</sup>	8.0 × 10 <sup>-9</sup>	2.1 × 10 <sup>-6</sup>	5.2 × 10 <sup>-9</sup>	1.5 × 10 <sup>-6</sup>	8.7 × 10 <sup>-9</sup>	5.8 × 10 <sup>-6</sup>	1.3 × 10 <sup>-8</sup>
<sup>65</sup> Zn	2.7 × 10 <sup>-5</sup>	3.1 × 10 <sup>-8</sup>	1.0 × 10 <sup>-4</sup>	1.1 × 10 <sup>-7</sup>	1.2 × 10 <sup>-5</sup>	1.7 × 10 <sup>-8</sup>	5.3 × 10 <sup>-5</sup>	5.5 × 10 <sup>-8</sup>	4.7 × 10 <sup>-5</sup>	4.8 × 10 <sup>-8</sup>	3.5 × 10 <sup>-5</sup>	4.0 × 10 <sup>-8</sup>	7.0 × 10 <sup>-5</sup>	7.2 × 10 <sup>-8</sup>
<sup>90</sup> Sr <sup>b</sup>	7.6 × 10 <sup>-9</sup>	2.4 × 10 <sup>-10</sup>	4.1 × 10 <sup>-8</sup>	3.3 × 10 <sup>-10</sup>	5.6 × 10 <sup>-9</sup>	2.3 × 10 <sup>-10</sup>	1.5 × 10 <sup>-8</sup>	1.5 × 10 <sup>-10</sup>	1.0 × 10 <sup>-8</sup>	9.8 × 10 <sup>-11</sup>	8.6 × 10 <sup>-9</sup>	2.8 × 10 <sup>-10</sup>	2.7 × 10 <sup>-8</sup>	1.8 × 10 <sup>-10</sup>
<sup>106</sup> Ru <sup>b</sup>	5.7 × 10 <sup>-8</sup>	8.9 × 10 <sup>-11</sup>	4.1 × 10 <sup>-7</sup>	5.1 × 10 <sup>-10</sup>	4.7 × 10 <sup>-8</sup>	7.7 × 10 <sup>-11</sup>	1.4 × 10 <sup>-7</sup>	1.7 × 10 <sup>-10</sup>	8.4 × 10 <sup>-8</sup>	1.1 × 10 <sup>-10</sup>	5.9 × 10 <sup>-8</sup>	9.6 × 10 <sup>-11</sup>	2.7 × 10 <sup>-7</sup>	3.3 × 10 <sup>-10</sup>
<sup>129</sup> I	3.4 × 10 <sup>-8</sup>	2.8 × 10 <sup>-9</sup>	1.6 × 10 <sup>-7</sup>	3.3 × 10 <sup>-9</sup>	3.0 × 10 <sup>-8</sup>	2.7 × 10 <sup>-9</sup>	5.6 × 10 <sup>-8</sup>	1.6 × 10 <sup>-9</sup>	3.6 × 10 <sup>-8</sup>	1.0 × 10 <sup>-9</sup>	3.8 × 10 <sup>-8</sup>	3.3 × 10 <sup>-9</sup>	1.0 × 10 <sup>-7</sup>	1.7 × 10 <sup>-9</sup>
<sup>131</sup> I	2.4 × 10 <sup>-10</sup>	6.1 × 10 <sup>-13</sup>	1.1 × 10 <sup>-9</sup>	7.2 × 10 <sup>-13</sup>	2.1 × 10 <sup>-10</sup>	6.0 × 10 <sup>-13</sup>	3.9 × 10 <sup>-10</sup>	3.4 × 10 <sup>-13</sup>	2.5 × 10 <sup>-10</sup>	2.2 × 10 <sup>-13</sup>	2.7 × 10 <sup>-10</sup>	7.1 × 10 <sup>-13</sup>	7.1 × 10 <sup>-10</sup>	3.8 × 10 <sup>-13</sup>
<sup>134</sup> Cs	5.9 × 10 <sup>-8</sup>	3.9 × 10 <sup>-9</sup>	2.1 × 10 <sup>-7</sup>	4.6 × 10 <sup>-9</sup>	4.6 × 10 <sup>-8</sup>	3.9 × 10 <sup>-9</sup>	8.7 × 10 <sup>-8</sup>	2.2 × 10 <sup>-9</sup>	6.3 × 10 <sup>-8</sup>	1.4 × 10 <sup>-9</sup>	7.0 × 10 <sup>-8</sup>	4.6 × 10 <sup>-9</sup>	1.4 × 10 <sup>-7</sup>	2.4 × 10 <sup>-9</sup>
<sup>137</sup> Cs <sup>b</sup>	4.1 × 10 <sup>-8</sup>	3.6 × 10 <sup>-9</sup>	1.5 × 10 <sup>-7</sup>	4.1 × 10 <sup>-9</sup>	3.2 × 10 <sup>-8</sup>	3.5 × 10 <sup>-9</sup>	6.0 × 10 <sup>-8</sup>	2.0 × 10 <sup>-9</sup>	4.4 × 10 <sup>-8</sup>	1.3 × 10 <sup>-9</sup>	4.9 × 10 <sup>-8</sup>	4.2 × 10 <sup>-9</sup>	9.4 × 10 <sup>-8</sup>	2.2 × 10 <sup>-9</sup>
<sup>210</sup> Pb <sup>b</sup>	2.5 × 10 <sup>-3</sup>	1.1 × 10 <sup>-5</sup>	1.2 × 10 <sup>-2</sup>	2.9 × 10 <sup>-5</sup>	1.4 × 10 <sup>-3</sup>	8.9 × 10 <sup>-6</sup>	5.3 × 10 <sup>-3</sup>	1.3 × 10 <sup>-5</sup>	4.2 × 10 <sup>-3</sup>	1.0 × 10 <sup>-5</sup>	3.2 × 10 <sup>-3</sup>	1.3 × 10 <sup>-5</sup>	7.9 × 10 <sup>-3</sup>	1.8 × 10 <sup>-5</sup>
<sup>210</sup> Po	7.6 × 10 <sup>-4</sup>	2.6 × 10 <sup>-6</sup>	3.8 × 10 <sup>-3</sup>	5.0 × 10 <sup>-6</sup>	4.6 × 10 <sup>-4</sup>	2.4 × 10 <sup>-6</sup>	1.6 × 10 <sup>-3</sup>	2.2 × 10 <sup>-6</sup>	1.2 × 10 <sup>-3</sup>	1.6 × 10 <sup>-6</sup>	9.2 × 10 <sup>-4</sup>	3.1 × 10 <sup>-6</sup>	2.5 × 10 <sup>-3</sup>	2.9 × 10 <sup>-6</sup>
<sup>226</sup> Ra <sup>b</sup>	2.6 × 10 <sup>-3</sup>	1.2 × 10 <sup>-5</sup>	1.2 × 10 <sup>-2</sup>	3.2 × 10 <sup>-5</sup>	1.4 × 10 <sup>-3</sup>	9.7 × 10 <sup>-6</sup>	5.3 × 10 <sup>-3</sup>	1.4 × 10 <sup>-5</sup>	4.3 × 10 <sup>-3</sup>	1.1 × 10 <sup>-5</sup>	3.2 × 10 <sup>-3</sup>	1.5 × 10 <sup>-5</sup>	8.0 × 10 <sup>-3</sup>	2.0 × 10 <sup>-5</sup>
<sup>230</sup> Th	8.7 × 10 <sup>-6</sup>	3.5 × 10 <sup>-7</sup>	3.8 × 10 <sup>-5</sup>	4.4 × 10 <sup>-7</sup>	5.8 × 10 <sup>-6</sup>	3.4 × 10 <sup>-7</sup>	1.6 × 10 <sup>-5</sup>	2.1 × 10 <sup>-7</sup>	1.2 × 10 <sup>-5</sup>	1.4 × 10 <sup>-7</sup>	1.0 × 10 <sup>-5</sup>	4.1 × 10 <sup>-7</sup>	2.5 × 10 <sup>-5</sup>	2.4 × 10 <sup>-7</sup>
<sup>232</sup> Th <sup>b</sup>	3.1 × 10 <sup>-5</sup>	7.3 × 10 <sup>-7</sup>	1.4 × 10 <sup>-4</sup>	1.0 × 10 <sup>-6</sup>	1.8 × 10 <sup>-5</sup>	7.0 × 10 <sup>-7</sup>	5.9 × 10 <sup>-5</sup>	4.7 × 10 <sup>-7</sup>	4.7 × 10 <sup>-5</sup>	3.2 × 10 <sup>-7</sup>	3.8 × 10 <sup>-5</sup>	8.6 × 10 <sup>-7</sup>	9.0 × 10 <sup>-5</sup>	5.5 × 10 <sup>-7</sup>
<sup>234</sup> U	2.9 × 10 <sup>-8</sup>	1.9 × 10 <sup>-10</sup>	1.9 × 10 <sup>-7</sup>	5.3 × 10 <sup>-10</sup>	2.2 × 10 <sup>-8</sup>	1.8 × 10 <sup>-10</sup>	6.7 × 10 <sup>-8</sup>	2.1 × 10 <sup>-10</sup>	4.4 × 10 <sup>-8</sup>	1.3 × 10 <sup>-10</sup>	3.2 × 10 <sup>-8</sup>	2.2 × 10 <sup>-10</sup>	1.3 × 10 <sup>-7</sup>	3.3 × 10 <sup>-10</sup>
<sup>238</sup> U <sup>b</sup>	1.7 × 10 <sup>-7</sup>	6.1 × 10 <sup>-9</sup>	7.9 × 10 <sup>-7</sup>	7.9 × 10 <sup>-9</sup>	1.2 × 10 <sup>-7</sup>	5.9 × 10 <sup>-9</sup>	3.2 × 10 <sup>-7</sup>	3.7 × 10 <sup>-9</sup>	2.4 × 10 <sup>-7</sup>	2.4 × 10 <sup>-9</sup>	2.0 × 10 <sup>-7</sup>	7.1 × 10 <sup>-9</sup>	5.2 × 10 <sup>-7</sup>	4.3 × 10 <sup>-9</sup>
<sup>239</sup> Pu	1.1 × 10 <sup>-5</sup>	9.0 × 10 <sup>-8</sup>	8.4 × 10 <sup>-5</sup>	2.4 × 10 <sup>-7</sup>	9.9 × 10 <sup>-6</sup>	8.8 × 10 <sup>-8</sup>	2.6 × 10 <sup>-5</sup>	8.9 × 10 <sup>-8</sup>	1.5 × 10 <sup>-5</sup>	5.3 × 10 <sup>-8</sup>	1.1 × 10 <sup>-5</sup>	1.0 × 10 <sup>-7</sup>	5.5 × 10 <sup>-5</sup>	1.5 × 10 <sup>-7</sup>
<sup>240</sup> Pu	1.1 × 10 <sup>-5</sup>	9.0 × 10 <sup>-8</sup>	8.4 × 10 <sup>-5</sup>	2.4 × 10 <sup>-7</sup>	9.9 × 10 <sup>-6</sup>	8.8 × 10 <sup>-8</sup>	2.6 × 10 <sup>-5</sup>	8.9 × 10 <sup>-8</sup>	1.5 × 10 <sup>-5</sup>	5.3 × 10 <sup>-8</sup>	1.1 × 10 <sup>-5</sup>	1.0 × 10 <sup>-7</sup>	5.5 × 10 <sup>-5</sup>	1.5 × 10 <sup>-7</sup>
<sup>241</sup> Am	4.4 × 10 <sup>-6</sup>	6.3 × 10 <sup>-8</sup>	2.7 × 10 <sup>-5</sup>	1.1 × 10 <sup>-7</sup>	3.3 × 10 <sup>-6</sup>	6.0 × 10 <sup>-8</sup>	9.7 × 10 <sup>-6</sup>	4.8 × 10 <sup>-8</sup>	6.5 × 10 <sup>-6</sup>	3.1 × 10 <sup>-8</sup>	4.9 × 10 <sup>-6</sup>	7.3 × 10 <sup>-8</sup>	1.8 × 10 <sup>-5</sup>	6.6 × 10 <sup>-8</sup>

<sup>a</sup> The world-average value is calculated using the world-average annual catch of fish, crustacea and molluscs from table 21.

<sup>b</sup> For these radionuclides the calculated doses include a contribution from the ingrowth of progeny (see appendix for details).

## VII. CONCLUSIONS

151. An important aspect of the Committee's work is the periodic assessment of global and regional radiation exposures to the public from discharges of radionuclides to the environment. Such studies require a robust, generic methodology that is defensible and takes into account developments in the field. The methodology used by the Committee for many years has proved to meet its needs for worldwide exposure assessments but, as previously, before any major evaluation of exposures, the methodology has been reviewed by the Committee to ensure its continued validity. An important factor for the current review was the decision by the Committee to update its evaluations of human radiation exposures from all significant types of electrical energy production. Following the review, the Committee decided to make some changes to parts of the methodology, while retaining other parts that it felt were still appropriate for its purposes. Previously, the results had often been expressed in terms of dose per unit of electricity generated but, for flexibility, it was agreed that the results be presented in terms of dose per unit of activity discharged.

152. The updated methodology can be used to estimate characteristic individual doses (typical of the average person living in the area around the source) and collective doses due to discharges to atmosphere, to freshwater bodies (small and large rivers or a lake) and to the sea. A wide range of radionuclides are included to enable exposures to be assessed for nuclear and non-nuclear forms of electrical energy production. The methodology applies to routine, continuous discharges only and it cannot be used for accidental releases; nor is it suitable for detailed site-specific assessments of doses to representative persons for regulatory purposes. As previously mentioned, local, regional and global components of collective dose are estimated, as appropriate. However, it is now possible to gain additional insight for discharges to atmosphere on collective doses within different distance bands from the discharge point. Global components of collective dose are now also available for integration times of 100, 500 and 10,000 years.

153. The methodology now includes factors for population densities and for food consumption rates that vary with geographical region. The Committee added this detail because non-nuclear power stations are found throughout the world where population densities and patterns of food consumption are significantly different from a generic world average. However, the geographical regions adopted are still very large and the inclusion of such region-specific data does not mean that the methodology is suitable for site-specific assessments. Another addition to the methodology is the inclusion of doses due to the irrigation of terrestrial foods with fresh water into which radionuclides had been discharged. The extent and nature of irrigation is very variable throughout the world but, for the purposes of this methodology, a simplified generic approach has been adopted for estimating exposures due to irrigation.

154. This scientific annex describes the methodology, outlines changes from previous versions and discusses its limitations and particular areas of uncertainty. Where possible, the results from applying the methodology have been compared with those from other methodologies and published studies. Although the purpose of the other studies would have influenced the developers' choice of models and parameter values and hence the estimated doses, the comparisons still helped to give confidence that the Committee's methodology is fit for its purposes.

155. The methodology has been implemented in a series of Excel® workbooks to ensure that it is transparent for use by the Committee in any future studies. It should also be relatively easy to update the methodology using such a system. The workbooks enable the user to obtain information on the important exposure pathways and radionuclides to gain insight for the Committee's work. The workbooks have been checked and verified by people not involved in their development.

156. The Committee considers that the methodology should also be transparent to the wider community and therefore, in addition to the information presented here, further detail is provided in electronic attachments available on the UNSCEAR website (<http://www.unscear.org/unscear/en/publications/2016.html>). The Committee is satisfied that the methodology, as implemented in the workbooks, is robust, builds on the strong position of the previous versions of the methodology and is suitable for assessing worldwide exposures due to routine discharges of radionuclides to the environment. It can be used to assess—in a consistent way—exposures due to releases from non-nuclear and nuclear sites of electricity generation including the related fuel-cycle sites (e.g. uranium mining and milling, nuclear fuel reprocessing and nuclear power stations that are being decommissioned).

## VIII. ACKNOWLEDGEMENTS

The Committee wishes to acknowledge with gratitude the experts directly involved in developing the methodology and the related workbooks, and those who carried out quality control checks, and support staff in their institutes who assisted them. In particular, the Committee would like to thank: the consultants, C. Robinson and J. Simmonds; the expert group, who provided valuable oversight and advice for the work; staff, T. Anderson and K. Jones, from Public Health England in the United Kingdom, who developed the workbook system and supported development of the methodology; and H. Grogan, who reviewed and checked the workbook system. The views expressed in the scientific annex and related material remain those of the Committee and do not necessarily represent the views of individual experts, the United Nations or its Member States.

### *Expert group*

*Co-chairs:* E. Waller (Canada)

*Members:* T. Anderson (United Kingdom), L. Anspaugh (United States), H. Grogan (United States), G. Hirth (Australia), K. Jones (United Kingdom), L. Hubbard (Sweden), R. Michel (Germany), J. Simmonds (United Kingdom)

*Observer:* G. Proehl (IAEA)

The Committee would also like to acknowledge with gratitude: the staff of the Metadata and Socio-Economics unit of UNEP/DEWA/GRID-GENEVA who analysed the population data around nuclear power plants; P. Verger and colleagues from WHO for their analyses of food consumption data; S. Golikov and M. Balonov for reviewing the model for external exposure from deposited material; and M. Tzivaki for conducting some specialized quality checks of the workbooks and their results.



## APPENDIX A. IMPLEMENTATION OF THE METHODOLOGY

A1. The aim of this appendix is to provide more details of how the Committee has implemented the methodology as a set of Excel<sup>®</sup> workbooks by describing the workbook design (including the end points considered, the mathematical equations to implement the methodology in the workbooks, and information on how the workbooks can be used to assess exposures from different types of discharge), details of how radioactive progeny have been treated, and quality assurance.

### I. WORKBOOK DESIGN

A2. The methodology has been implemented as a series of Excel<sup>®</sup> workbooks from which dose calculation factors (i.e. the calculated individual and collective doses from unit discharge of radionuclides under a set of defined conditions) can be derived. The series includes a workbook for each environment into which a discharge can be made (i.e. atmosphere, freshwater bodies, and marine environments); a further workbook summarizes the doses due to discharges into each of the three environments, and another provides dose values for globally circulating radionuclides. Table A1 summarizes the various end points that are produced by the workbooks, and how the relevant populations and pathways are treated.

A3. The workbook for each environment into which a discharge is made comprises a number of interlinked worksheets. An initial status worksheet describes the purpose of the workbook and provides key information about its format and contents, version and quality control. Other worksheets contain values of the model input parameters (radionuclide-specific ones and others such as habit data); intermediate calculations (e.g. of activity concentrations of radionuclides as a function of distance for discharges to atmosphere); and output values for the end points (i.e. dose calculation factors).

A4. *Discharges to atmosphere.* The workbook first calculates activity concentrations of radionuclides in air at a number of distances from the point of discharge. Deposition rates and activity concentrations of radionuclides on the ground surface, in soil and in crops, meat and milk are derived for each distance. These activity concentrations are used to calculate characteristic individual and collective doses due to inhalation of the plume, and due to external exposure from radionuclides in the plume and deposited on the ground. Consumption rates of terrestrial food for different geographical regions are used to calculate characteristic individual and collective doses from consumption of foods. Table A2 lists the equations that are implemented for discharges to an atmospheric environment that give rise to exposure through terrestrial pathways.

A5. *Discharges to a freshwater environment.* The workbook calculates activity concentrations of radionuclides in water for two sizes of river (the results for a large river are also applied for a lake). Concentration factors are used to derive activity concentrations in freshwater fish, and irrigation rates are used to calculate activity concentrations in irrigated crops. Activity concentrations of radionuclides in riverbank sediment are assumed to be the same as those in riverbed sediment. These values are used to derive characteristic individual and collective doses from consumption of irrigated foods and water

abstracted from the river, consumption of fish caught from the river and individual doses from external exposure to radioactive material in riverbank sediments. Table A3 lists the equations implemented for discharges to a freshwater environment.

A6. *Discharges to a marine environment.* The workbook is based on the assumption that radionuclides are discharged to a relatively small, local compartment and water in the local compartment is exchanged with that in a larger, regional compartment. Activity concentrations in water are calculated for each compartment, and activity concentrations in fish, crustaceans, molluscs and beach sediment are derived. The workbook calculates individual doses from external exposure to beach sediment, and individual and collective doses from consumption of shellfish harvested in the local compartment and consumption of fish caught in both compartments. Table A4 lists the relevant equations for discharges to a marine environment.

A7. *Summary workbook.* This is linked to the above workbooks for each environment into which a discharge is made and, for this reason, must be saved in the same electronic folder as them. It presents characteristic individual and collective doses for each geographical region from discharges to atmospheric, freshwater and marine environments. The doses from discharges of radionuclides with very short-lived progeny (e.g.  $^{137}\text{Cs}$  and  $^{137\text{m}}\text{Ba}$ ) include the contributions from radioactive progeny. In other cases (i.e. radionuclides with longer-lived progeny), the contribution from the progeny are considered separately (see section II below). If the degree of equilibrium between different members of the radionuclide chain is significantly different from that assumed here, then the doses from the parent and progeny have to be summed once the activity of radionuclides in the discharge and the degree of equilibrium are specified.

A8. *Globally circulating radionuclides.* The final workbook includes calculation factors for collective doses from the global circulation of the relevant radionuclides for 100, 500 and 10,000 years following unit discharge. These factors have been derived using the PC-CREAM 08 computer system [S8], which implements each of the global circulation models adopted by the Committee.

A9. The results can be scaled by the actual rates of discharge of each radionuclide from a particular site and then summed over all relevant radionuclides to give the overall characteristic individual and collective doses. Results are produced for sites located in different regions of the world, with additional results for coastal and inland nuclear sites and sites situated in areas of low population density.

## II. TREATMENT OF RADIOACTIVE PROGENY

A10. For most radionuclides the workbooks for atmospheric, freshwater and marine environments provide the relevant dose factors separately for the parent and any progeny. (This permits the workbooks to be used when non-equilibrium conditions apply). Tables A5, A6 and A7 contain further details on how dose contributions from radioactive progeny have been treated for terrestrial, freshwater and marine pathways respectively, following the general principles outlined in section II.D.2. The summary workbook contains summed values based on the assumptions detailed in those tables. However, for radionuclides that are in secular equilibrium with their short-lived progeny, the doses presented and clearly marked in the workbooks are the sums of the doses from the parent and progeny.

### III. QUALITY ASSURANCE

A11. A systematic review of the completed workbooks was carried out for quality assurance purposes, firstly by the workbook developers and then by independent reviewers. This included a comparison of the parameter values and variables with source data, and the workbook equations with the agreed calculation methodology, defined by the lists of equations and data presented below in tables A2-A4. This ensured that the workbooks had implemented the methodology agreed by the Committee.

A12. As further verification, a workbook was created that compared a sample of the results of the workbooks with those published in the UNSCEAR 2000 Report [U6]. The results are discussed in detail in electronic attachment 1.





## TABLES

Table A1. Summary of end points, populations and pathways considered

(a) Characteristic individual dose

<i>End point/pathway</i>	<i>Key features of methodology</i>	<i>Integration considerations</i>
DISCHARGE TO ATMOSPHERE		
Characteristic individual dose	Total dose from all exposure pathways assuming location 5 km distant from site of discharge	Time integration: 100 years Individual dose in 100th year following 100 years continuous discharge
External irradiation (beta + gamma radiation from plume, and gamma radiation from deposited radionuclides)	Activity concentrations of radionuclides in plume derived using approach in [U6] Time-integrated activity concentrations in soil from [S8] Dose factors (table A3 below)	
Inhalation	Activity concentrations of radionuclides in plume derived using approach in [U6]	
Ingestion of terrestrial foods	Activity concentrations of radionuclides in terrestrial foods per unit deposition rate from [S8] Approaches for <sup>14</sup> C and <sup>3</sup> H based on [I5]	
DISCHARGE TO FRESHWATER ENVIRONMENT		
Characteristic individual dose	Total dose from all exposure pathways assuming complete instantaneous mixing For two situations: discharge into large and small rivers (for nuclear and mines/non-nuclear discharges, respectively)	Time integration: 100 years Individual dose in 100th year following 100 years continuous discharge
External irradiation from occupancy on freshwater sediments	Time-integrated activity concentrations of radionuclides in sediment from [S8] 5 km distant from discharge point	
Drinking water	Ingestion rate from [U6]	
Fish ingestion	Region-specific consumption rates from [F3]	
Ingestion of irrigated terrestrial foods	Deposition rate related to generic irrigation rate and growing period appropriate for grain [W2] Approaches for <sup>14</sup> C and <sup>3</sup> H derived from [C1]	
DISCHARGE TO MARINE ENVIRONMENT		
Characteristic individual dose	Total dose from exposure pathways calculated using a two-compartment model Activity concentrations of radionuclides in seawater in local marine compartment	Time integration: 100 years Individual dose in 100th year following 100 years continuous discharge
External irradiation from occupancy on marine sediments	Time-integrated activity concentrations of radionuclides in sediments within the local marine box [S8]	
Ingestion of marine foods (fish, crustaceans and molluscs)	Ingestion of crustaceans and molluscs from the local compartment (25%) and regional compartment (75%)	

## (b) Collective dose

<i>Component</i>	<i>Key features of methodology</i>	<i>Integration considerations</i>
<b>DISCHARGE TO ATMOSPHERE</b>		
Local component	Based on individual dose at midpoint and number of people in annuli around discharge point derived from population density information from [F1] for nuclear sites or using a population density of 5 km <sup>-2</sup> for sites in areas of low population (see electronic attachment 3)	Time integration: 100 years Distance integration: using activity concentrations of radionuclides and individual doses at centre point of annular area, 0–100 km
Regional component	Based on individual dose and number of people in annuli around discharge point for nuclear sites (see electronic attachment 3) or derived from weighted population density information from [F1]	Time integration: 100 years, 500 years Distance integration: using activity concentrations of radionuclides and individual doses at centre point of following annular areas: 100–500, 500–1 000 and 1 000–1 500 km For discharge continuing for 100 years and integration times of 100 years
Global component	Based on collective dose from globally dispersed radionuclides [S8], which implements models referred to in [U6]	Time integration: 100 years, 500 years and 10 000 years
<b>DISCHARGE TO FRESHWATER ENVIRONMENT</b>		
Local and regional components from freshwater pathways (external irradiation from exposure on freshwater sediment not included)	Based on total collective intakes from abstraction of drinking water and freshwater fish-catch data from specified lengths of small and large rivers Consumption of irrigated terrestrial foods based on generalized yield data and areas of land equipped for irrigation as function of region (from [F1])	Time integration: 100 years
Global component	Based on collective dose from globally dispersed radionuclides [S8], which implements models referred to in [U6]	
<b>DISCHARGE TO MARINE ENVIRONMENT</b>		
Regional component (External exposure on marine sediment not included)	Based on total collective intake from seafood-catch data derived from the representative regional marine compartment	Time integration: 100 years
Global component	Based on collective dose from globally dispersed radionuclides [S8], which implements models referred to in [U6]	

Table A2. Parameter and equation list: Atmospheric discharge and terrestrial environment

Parameter	Symbol	Value	Units	Reference
<b>ATMOSPHERIC DISPERSION</b>				
Activity concentration in air at a specified distance calculated using:				
$C_{\text{air},i}(x) = D_1 \cdot Q \cdot x^{-n} e^{-\lambda_i x/u_a} \quad (\text{T1})$				
Activity concentration of radionuclide, <i>i</i> , in air at distance, <i>x</i> , from discharge point	$C_{\text{air},i}(x)$	Equation (T1)	Bq/m <sup>3</sup>	—
Dilution factor at 1 km	$D_1$	$5.3 \times 10^{-7}$	s/m <sup>3</sup>	[U6]
Discharge rate	$Q$	Unit discharge rate = 1	Bq/s	—
Downwind distance from discharge point	$x$	5, 50, 300, 750, 1 250	km	—
Empirical index	$n$	Noble gases, tritium: 1.2 <sup>14</sup> C: 1.4 All others: 1.42	—	[U6]
Radioactive decay constant of radionuclide, <i>i</i>	$\lambda_i$	Radionuclide-specific	s <sup>-1</sup>	[I9]
Geometric mean of wind speed at the height of release representative of one year	$u_a$	$2 \times 10^{-3}$	km/s	[I2]
Activity concentration in air of <sup>135</sup> Cs (progeny of <sup>135</sup> Xe) and <sup>138</sup> Cs (progeny of <sup>138</sup> Xe) calculated using:				
$C_{\text{air},\text{progeny}}(x) = C_{\text{air},\text{parent}}(x) \frac{\lambda_{\text{parent}}}{\lambda_{\text{progeny}} - \lambda_{\text{parent}}} \left( 1 - e^{-(\lambda_{\text{progeny}} - \lambda_{\text{parent}})(x/u_a)} \right) \quad (\text{T2})$				
(note this equation is valid for one progeny and does not include a branching fraction)				
Activity concentration of progeny in air at distance, <i>x</i> , from discharge point	$C_{\text{air},\text{progeny}}(x)$	Equation (T2)	Bq/m <sup>3</sup>	—
Activity concentration of parent in air at distance, <i>x</i> , from discharge point	$C_{\text{air},\text{parent}}(x)$	Equation (T1)	Bq/m <sup>3</sup>	—
Radioactive decay constant of parent/progeny	$\lambda_{\text{parent}}, \lambda_{\text{progeny}}$	Radionuclide-specific	s <sup>-1</sup>	[I9]
Downwind distance from discharge point	$x$	5, 50, 300, 750, 1 250	km	—
Geometric mean of wind speed at the height of release representative of one year	$u_a$	$2 \times 10^{-3}$	km/s	[I2]
Deposition rate at a specified distance calculated using:				
$\dot{d}_i(x) = V_T C_{\text{air},i}(x) \quad (\text{T3})$				
Total daily-average deposition rate at distance, <i>x</i> , of radionuclide, <i>i</i> , from both wet and dry processes	$\dot{d}_i(x)$	Equation (T3)	Bq/(m <sup>2</sup> s)	—

Parameter	Symbol	Value	Units	Reference
Total deposition velocity (wet and dry)	$V_T$	Noble and non-reactive gases: 0 Tritium: 0 $^{14}\text{C}$ : 0 All others: 0.002	m/s	[U6]
Activity concentration of radionuclide, $i$ , in air at distance, $x$ , from discharge point	$C_{\text{air},i}(x)$	Equations (T1), (T2)	Bq/m <sup>3</sup>	—
ENVIRONMENTAL TRANSFER				
Activity concentration in terrestrial food calculated using:				
		$C_{f,i}(x) = C_{f,\text{unit},i} \dot{d}_i(x)$		(T4)
Activity concentration of radionuclide, $i$ , in terrestrial food, $f$ , at distance, $x$ , from discharge point	$C_{f,i}(x)$	Equation (T4)	Bq/kg or Bq/L	—
Activity concentration of radionuclide, $i$ , in year 100 in terrestrial food, $f$ , per unit deposition rate for continuous deposition	$C_{f,\text{unit},i}$	PC-CREAM output [S8]	Bq/kg per Bq/(m <sup>2</sup> s) or Bq/L per Bq/(m <sup>2</sup> s)	—
Total daily average deposition rate at distance, $x$ , of radionuclide, $i$ , from both wet and dry processes	$\dot{d}_i(x)$	Equation (T3)	Bq/(m <sup>2</sup> s)	—
$^{14}\text{C}$ activity concentration in terrestrial food (cereal, vegetables and pasture) calculated using:				
		$C_{f,^{14}\text{C}}(x) = C_{\text{air},^{14}\text{C}}(x) \cdot \frac{S_p}{S_{\text{air}}}$		(T5)
Activity concentration of $^{14}\text{C}$ in food, and pasture, $f$ , at distance, $x$ , from discharge point	$C_{f,^{14}\text{C}}(x)$	Equation (T5)	Bq/kg	[15]
Activity concentration of $^{14}\text{C}$ in air at distance, $x$ , from discharge point	$C_{\text{air},^{14}\text{C}}(x)$	Equation (T1)	Bq/m <sup>3</sup>	—
Concentration of stable carbon in the plant (fresh weight)	$S_p$	Cereal: $3.9 \times 10^2$ Vegetables: 30 Pasture: $1 \times 10^2$	g C/kg	[15]
Concentration of stable carbon in air	$S_{\text{air}}$	0.2	g C/m <sup>3</sup>	[15]
$^{14}\text{C}$ activity concentration in terrestrial food (animal products) calculated using:				
		$C_{f,^{14}\text{C}}(x) = \frac{f_c \cdot C_{\text{pasture},^{14}\text{C}}(x) \cdot S_a}{S_p}$		(T6)
Activity concentration of $^{14}\text{C}$ in food, $f$ , at distance, $x$ , from discharge point	$C_{f,^{14}\text{C}}(x)$	Equation (T6)	Bq/kg	[15]
Fraction of animal feed that is contaminated	$f_c$	1	—	[15]
Activity concentration of $^{14}\text{C}$ in pasture at distance, $x$ , from discharge point	$C_{\text{pasture},^{14}\text{C}}(x)$	Equation (T5)	Bq/kg	—

Parameter	Symbol	Value	Units	Reference
Concentration of stable carbon in the animal product (fresh weight)	$S_a$	Milk: 65 Beef: 200	g/kg	[15]
Concentration of stable carbon in the plant (fresh weight)	$S_p$	Pasture: $1 \times 10^2$	g/kg	[15]
Activity concentration of HTO in soil water calculated using:				
$C_{sw,HTO}(x) = \frac{CR_{s-a} \cdot C_{air,HTO}(x)}{H_a} \quad (T7)$				
Activity concentration of HTO in soil water at distance, $x$ , from discharge point	$C_{sw,HTO}(x)$	Equation (T7)	Bq/L	[15]
Empirical constant	$CR_{s-a}$	0.3	—	[15]
Activity concentration of HTO in air at distance, $x$ , from discharge point	$C_{air,HTO}(x)$	Equation (T1)	Bq/m <sup>3</sup>	—
Absolute humidity	$H_a$	$6 \times 10^{-3}$	L/m <sup>3</sup>	[15]
Calculated using:				
$C_{f,HTO}(x) = WC_p \cdot \left[ RH \frac{C_{air,HTO}(x)}{H_a} + (1 - RH) C_{sw,HTO}(x) \right] / \gamma \quad (T8)$				
Activity concentration of HTO in food, $f$ , at distance, $x$ , from discharge point (fresh weight)	$C_{f,HTO}(x)$	Equation (T8)	Bq/kg	[15]
Fractional water content of the plant (fresh weight)	$WC_p$	Cereal: 0.12 Vegetables: 0.92 Pasture: 0.76	L/kg	[15]
Relative humidity	RH	0.7	—	[14]
Activity concentration of HTO in air at distance, $x$ , from discharge point	$C_{air,HTO}(x)$	Equation (T1)	Bq/m <sup>3</sup>	—
Absolute humidity	$H_a$	$6 \times 10^{-3}$	L/m <sup>3</sup>	[12]
Activity concentration of HTO in soil water at distance, $x$ , from discharge point	$C_{sw,HTO}(x)$	Equation (T7)	Bq/L	[15]
Ratio of HTO vapour pressure to H <sub>2</sub> O vapour pressure	$\gamma$	0.909	—	[15]
Weighted concentration of HTO in drinking water and feed calculated using:				
$CR_{f,HTO}(x) = 0.5 \cdot C_{sw,HTO}(x) + 0.5 \cdot \frac{C_{pasture,HTO}(x)}{WC_p} \quad (T9)$				
Weighted concentration of HTO in drinking water and of water in feed (assumes that 50% intake is drinking water and 50% is pasture)	$CR_{f,HTO}(x)$	Equation (T9)	Bq/L	—

Parameter	Symbol	Value	Units	Reference
Activity concentration of HTO in soil water at distance, $x$ , from discharge point	$C_{sw,HTO}(x)$	Equation (T7)	Bq/L	[15]
Activity concentration of HTO in pasture at distance, $x$ , from discharge point (fresh weight)	$C_{pasture,HTO}(x)$	Equation (T8)	Bq/kg	[15]
Fractional water content of the plant	$WC_p$	0.76	L/kg	[15]
HTO activity concentration in terrestrial food (animal products) calculated using:				
		$C_{f,HTO}(x) = CR_{a,HTO} \cdot CR_{f,HTO}(x)$		(T10)
Activity concentration of HTO in food, $f_i$ , at distance, $x$ , from discharge point	$C_{f,HTO}(x)$	Equation (T10)	Bq/kg	[15]
Concentration ratio: concentration of HTO in product (fresh weight) divided by concentration of HTO in water intake	$CR_{a,HTO}$	Milk: 0.87 Beef: 0.66	L/kg	[15]
Weighted concentration of HTO in drinking water and of water in feed	$CR_{f,HTO}(x)$	Equation (T9)	Bq/L	—
OBT activity concentration in terrestrial food (cereal, vegetables and pasture) calculated using:				
		$C_{f,OBT}(x) = (1 - WC_p) \cdot \frac{WEQ_p \cdot R_p \cdot C_{f,HTO}(x)}{WC_p}$		(T11)
Activity concentration of OBT in food, $f_i$ , at distance, $x$ , from discharge point	$C_{f,OBT}(x)$	Equation (T11)	Bq/kg	[15]
Fractional water content of the plant (fresh weight)	$WC_p$	Cereal: 0.12 Vegetables: 0.92 Pasture: 0.76	L/kg	[15]
Water equivalent factor	$WEQ_p$	Cereal: 0.56 Vegetables: 0.51 Pasture: 0.56	L/kg	[15]
Partition factor	$R_p$	0.54	—	[15]
Activity concentration of HTO in food, $f_i$ , at distance, $x$ , from discharge point	$C_{f,HTO}(x)$	Equation (T8)	Bq/kg	[15]
OBT activity concentration in terrestrial food (animal products)				
		$C_{f,OBT}(x) = CR_{a,OBT} \cdot C_{pasture,OBT}(x)$		(T12)
Activity concentration of OBT in food, $f_i$ , at distance, $x$ , from discharge point	$C_{f,OBT}(x)$	Equation (T12)	Bq/kg	[15]
Concentration ratio: concentration of OBT in milk (fresh weight) divided by concentration of OBT in intake (dry weight)	$CR_{a,OBT}$	Milk: 0.24 Beef: 0.40	kg/L	[15]
Mean concentration of OBT in feed	$C_{pasture,OBT}(x)$	Equation (T11)	Bq/kg	—

Parameter	Symbol	Value	Units	Reference
INDIVIDUAL DOSE CALCULATIONS				
Effective dose from inhalation at a specified distance calculated using:				
$H_{E(\text{inh}),i}(x) = C_{\text{air},i}(x) \cdot D_{\text{inh},i} \cdot \frac{I_{\text{inh}}}{86\,400} \cdot O_{\text{ann}} \quad (\text{T13})$				
Effective dose from inhalation of radionuclide, <i>i</i> , at distance, <i>x</i> , from discharge point	$H_{E(\text{inh}),i}(x)$	Equation (T13)	Sv	—
Activity concentration of radionuclide, <i>i</i> , in air at distance, <i>x</i> , from discharge point	$C_{\text{air},i}(x)$	Equation (T1)	Bq/m <sup>3</sup>	—
Dose coefficient for inhalation of radionuclide, <i>i</i> , (see equation (T14) for calculation of dose coefficient for <sup>222</sup> Rn plus short-lived progeny)	$D_{\text{inh},i}$	Dependent on radionuclide	Sv/Bq	[I14]
Adult inhalation rate	$I_{\text{inh}}$	20	m <sup>3</sup> /d	[U6]
Conversion factor		86 400	s/d	—
Annual occupancy at location	$O_{\text{ann}}$	$3.15 \times 10^7$ (rounded)	s	—
Dose coefficient for inhalation of radon and its short-lived progeny calculated using:				
$D_{\text{inh},^{222}\text{Rn}} = 24 \cdot \frac{\text{DC}_{^{222}\text{Rn}} \left( \text{EF}_{^{222}\text{Rn},\text{in}} \cdot O_{^{222}\text{Rn},\text{in}} + \text{EF}_{^{222}\text{Rn},\text{out}} \cdot O_{^{222}\text{Rn},\text{out}} \right)}{I_{\text{inh}}} \quad (\text{T14})$				
Dose coefficient for inhalation of <sup>222</sup> Rn plus short-lived progeny	$D_{\text{inh},^{222}\text{Rn}}$	Equation (T14)	Sv/Bq	[U6]
Conversion factor		24	h/d	—
Dose conversion factor for radon	$\text{DC}_{^{222}\text{Rn}}$	$9 \times 10^{-9}$	Sv per (Bq h/m <sup>3</sup> )	[U6]
Indoor equilibrium factor for radon	$\text{EF}_{^{222}\text{Rn},\text{in}}$	0.4	—	[U6]
Indoor occupancy factor	$O_{^{222}\text{Rn},\text{in}}$	0.8	—	[U6]
Outdoor equilibrium factor for radon	$\text{EF}_{^{222}\text{Rn},\text{out}}$	0.6	—	[U6]
Outdoor occupancy factor	$O_{^{222}\text{Rn},\text{out}}$	0.2	—	[U6]
Adult inhalation rate	$I_{\text{inh}}$	20	m <sup>3</sup> /d	[U6]
Dose from external exposure from immersion in the plume at a specified distance calculated using:				
$H_{E(\text{ex,cloud}),i}(x) = C_{\text{air},i}(x) \cdot D_{\text{ex,cloud},i} \cdot O_{\text{ann}} \cdot (O_{\text{out}} + (1 - O_{\text{out}}) L_{\text{cloud}}) \quad (\text{T15})$				
Effective gamma dose from external exposure to radionuclide, <i>i</i> , at distance, <i>x</i> , from discharge point	$H_{E(\text{ex,cloud}),i}(x)$	Equation (T15)	Sv	—

Parameter	Symbol	Value	Units	Reference
Activity concentration of radionuclide, $i$ , in air at distance, $x$ , from discharge point	$C_{\text{air},i}(x)$	Equation (T1)	Bq/m <sup>3</sup>	—
External dose coefficient for immersion in the plume	$D_{\text{ex,cloud},i}$	Dependent on radionuclide	Sv per (Bq s/m <sup>3</sup> )	[E2, P2]
Annual occupancy at location	$O_{\text{ann}}$	$3.15 \times 10^7$ (rounded)	s	—
Fraction of occupancy that is outdoors	$O_{\text{out}}$	0.2	—	[U4]
Building shielding factor in plume (location factor)	$L_{\text{cloud}}$	0.2	—	
Dose from external exposure from deposits calculated using:				
$H_{E(\text{ex,deposit}),i}(x) = \dot{d}_i(x) \cdot t_{\text{discharge}} \cdot D_{\text{ex,deposit},i} \cdot (O_{\text{out}} + (1 - O_{\text{out}})L_{\text{deposit}}) \quad (\text{T16})$				
Annual effective dose from the deposited radionuclide, $i$ , at distance, $x$ , from discharge point	$H_{E(\text{ex,deposit}),i}(x)$	Equation (T16)	Sv	—
Total daily average deposition rate at distance, $x$ , of radionuclide, $i$ , from both wet and dry processes	$\dot{d}_i(x)$	Equation (T3)	Bq s/m <sup>2</sup>	—
Duration of deposition	$t_{\text{discharge}}$	$3.15 \times 10^7$ (rounded)	s	1 year
Dose coefficient for external exposure from deposited material, integrated to 100 years (time dependence taken into account using equation given by [G2])	$D_{\text{ex,deposit},i}$	Dependent on radionuclide	Sv per (Bq/m <sup>2</sup> )	[E2, P2]
Fraction of occupancy that is outdoors	$O_{\text{out}}$	0.2	—	[U4]
Building shielding factor from deposited material (location factor)	$L_{\text{deposit}}$	0.1	—	
Effective dose from ingestion calculated using:				
$H_{E(\text{ing}),f,r,i}(x) = C_{f,i}(x) \cdot D_{\text{ing},i} \cdot F_{\text{local}} \cdot I_{f,r} \quad (\text{T17})$				
Annual effective dose from the ingestion of food, $f$ , containing radionuclide, $i$ , at distance, $x$ , from discharge point in region $r$	$H_{E(\text{ing}),f,r,i}(x)$	Equation (T17)	Sv	—
Activity concentration of radionuclide, $i$ , in terrestrial food, $f$ , at distance, $x$ , from discharge point	$C_{f,i}(x)$	Equations (T4), (T5), (T6), (T8), (T10), (T11), (T12)	Bq/kg or Bq/L	—
Dose coefficient for ingestion	$D_{\text{ing},i}$	Dependent on radionuclide	Sv/Bq	[I14]
Fraction of food that is locally produced	$F_{\text{local}}$	Individual dose: 0.25 Collective dose: 1.0	—	
Amount of food, $f$ , ingested per caput in a year in region, $r$	$I_{f,r}$	Dependent on region and food	kg or L	[W2]



Parameter	Symbol	Value	Units	Reference
Total effective dose from ingestion calculated using:				
		$H_{E(\text{ing}),r,i}(x) = \sum_f H_{E(\text{ing}),f,r,i}(x)$		(T18)
Total annual effective dose in region, $r$ , from ingestion of radionuclide, $i$ , in food at distance, $x$ , from discharge point	$H_{E(\text{ing}),r,i}(x)$	Equation (T18)	Sv	—
Annual effective dose from ingestion of food, $f$ , containing radionuclide, $i$ , at distance, $x$ , from discharge point in region, $r$	$H_{E(\text{ing}),f,r,i}(x)$	Equation (T17)	Sv	—
Total individual effective dose calculated using:				
		$H_{E(\text{atmos}),r,i}(x) = H_{E(\text{inh}),i}(x) + H_{E(\text{ex,cloud}),i}(x) + H_{E(\text{ex,deposit}),i}(x) + H_{E(\text{ing}),r,i}(x)$		(T19)
Total effective dose in region, $r$ , from radionuclide, $i$ , at distance, $x$ , from discharge point	$H_{E(\text{atmos}),r,i}(x)$	Equation (T19)	Sv	—
Effective dose from inhalation of radionuclide, $i$ , at distance, $x$ , from discharge point	$H_{E(\text{inh}),i}(x)$	Equation (T13)	Sv	—
Effective dose from external exposure to radionuclide, $i$ , at distance, $x$ , from discharge point	$H_{E(\text{ex,cloud}),i}(x)$	Equation (T15)	Sv	—
Effective dose from the deposited radionuclide, $i$ , at distance, $x$ , from discharge point	$H_{E(\text{ex,deposit}),i}(x)$	Equation (T16)	Sv	—
Total effective dose in region, $r$ , from ingestion of radionuclide, $i$ , in food at distance, $x$ , from discharge point	$H_{E(\text{ing}),r,i}(x)$	Equation (T18)	Sv	—
COLLECTIVE DOSE CALCULATIONS				
Collective effective dose calculated using:				
		$S_{E(\text{atmos}),r,i}(x_k, x_{k+1}) = N_r(x_k, x_{k+1}) \cdot H_{E(\text{atmos}),r,i}(x)$		(T20)
Collective effective dose in region, $r$ , in the annulus limited by $x_k$ and $x_{k+1}$	$S_{E(\text{atmos}),r,i}(x_k, x_{k+1})$	Equation (T20)	man Sv	—
Total population in region, $r$ , in the annulus limited by $x_k$ and $x_{k+1}$	$N_r(x_k, x_{k+1})$	Dependent on region		see electronic attachment 3 and [F1]
Annular distances (the outer distance for each annuli)	$(x_1, x_2, x_3, x_4, x_5)$	$\{0, 100, 500, 1\,000, 1\,500\}$	km	—
Total effective dose from radionuclide, $i$ , at distance, $x$ , from discharge point where $x$ is the midpoint between $x_k$ and $x_{k+1}$	$H_{E(\text{atmos}),r,i}(x)$	Equation (T19)	Sv	—

Parameter	Symbol	Value	Units	Reference
Local collective effective dose calculated using:				
		$S_{E(\text{atmos}),r,i}(\text{local}) = \sum_{k=1}^2 S_{E(\text{atmos}),r,i}(x_k, x_{k+1})$		(T21)
Local (0 km to 100 km) collective effective dose in region, $r$ , from radionuclide, $i$	$S_{E(\text{atmos}),r,i}(\text{local})$	Equation (T21)	man Sv	—
Total annual collective effective dose in region, $r$ , from radionuclide, $i$ , in the annulus limited by $x_k$ and $x_{k+1}$	$S_{E(\text{atmos}),r,i}(x_k, x_{k+1})$	Equation (T20)	man Sv	—
Regional component of collective effective dose				
		$S_{E(\text{atmos}),r,i}(\text{regional}) = \sum_{k=3}^5 S_{E(\text{atmos}),r,i}(x_k, x_{k+1})$		(T22)
Regional component (100 km to 1500 km) of collective effective dose in region, $r$ , from radionuclide, $i$	$S_{E(\text{atmos}),r,i}(\text{regional})$	Equation (T21)	man Sv	—
Total annual collective effective dose in region, $r$ , from radionuclide, $i$ , in the annulus limited by $x_k$ and $x_{k+1}$	$S_{E(\text{atmos}),r,i}(x_k, x_{k+1})$	Equation (T20)	man Sv	—
GLOBAL DISPERSION				
Collective doses from tritium, $^{14}\text{C}$ , $^{85}\text{Kr}$ and $^{129}\text{I}$ were calculated by PC-CREAM (incorporates global dispersion models referenced in [U6])				

Table A3. Parameter and equation list: Freshwater environment

Parameter	Symbol	Value	Units	Reference
<b>FRESHWATER DISPERSION</b>				
Activity concentration in unfiltered water calculated using:				
$C_{uw,s} = \frac{Q}{F_{river,s}} \quad (F1)$				
Activity concentration in unfiltered water	$C_{uw,s}$	Equation (F1)	Bq/m <sup>3</sup>	—
Annual discharge rate of radionuclide, $i$	$Q$	1	Bq/s	—
Volumetric flow rate of river of size, $s$	$F_{river,s}$	Large: 1 000 Small: 10	m <sup>3</sup> /s	—
Activity concentration in filtered water calculated using:				
$C_{fw,s,i} = \frac{C_{uw,s}}{1 + K_{d,i} \cdot \alpha_s} \quad (F2)$				
Activity concentration of radionuclide, $i$ , in filtered water from river of size, $s$	$C_{fw,s,i}$	Equation (F2)	Bq/m <sup>3</sup>	—
Activity concentration in unfiltered water	$C_{uw,s}$	Equation (F1)	Bq/m <sup>3</sup>	—
Sediment–water distribution factor	$K_{d,i}$	Dependent on element	m <sup>3</sup> /t	[I2, I5]
Suspended sediment load in river of size, $s$	$\alpha_s$	Large: $5 \times 10^{-4}$ Small: $2 \times 10^{-5}$	t/m <sup>3</sup>	[O1]
<b>ENVIRONMENTAL TRANSFERS</b>				
Activity concentrations in freshwater fish calculated using:				
$C_{fish,s,i} = \frac{C_{fw,s,i} \cdot B_{fish,i}}{1000} \quad (F3)$				
Activity concentration of radionuclide, $i$ , in freshwater fish	$C_{fish,s,i}$	Equation (F3)	Bq/kg	—
Activity concentration of radionuclide, $i$ , in filtered water from river of size, $s$	$C_{fw,s,i}$	Equation (F2)	Bq/m <sup>3</sup>	—
Concentration factor for freshwater fish (fresh weight)	$B_{fish,i}$	Dependent on food and element	Bq/kg per Bq/L	[I5]
Conversion factor		1 000	L/m <sup>3</sup>	—
Activity concentration of HTO in fish calculated using:				
$C_{fish,s,HTO} = \frac{WC_f \cdot C_{fw,s,HTO}}{1000} \quad (F4)$				
Activity concentration of HTO in freshwater fish	$C_{fish,s,HTO}$	Equation (F4)	Bq/kg	—

Parameter	Symbol	Value	Units	Reference
Fractional water content of fish (fresh weight)	$WC_f$	0.78	L/kg	[I5]
Activity concentration of HTO in filtered water from river of size, $s$	$C_{fw,s,HTO}$	Equation (F2)	Bq/m <sup>3</sup>	—
Conversion factor		1 000	L/m <sup>3</sup>	—
Activity concentration of OBT in fish calculated using:				
$C_{fish,s,OBT} = \frac{(1 - WC_f) \cdot WEQ_f \cdot R_f \cdot C_{fw,s,HTO}}{1000} \quad (F5)$				
Activity concentration of OBT in freshwater fish	$C_{fish,s,OBT}$	Equation (F5)	Bq/kg	—
Fractional water content of fish (fresh weight)	$WC_f$	0.78	L/kg	[I5]
Water equivalent factor for fish	$WEQ_f$	0.65	—	[I5]
Partition factor for fish (geometric mean, fresh weight)	$R_f$	$6.6 \times 10^{-4}$	kg/kg	[I5]
Activity concentration of HTO in filtered water from river of size, $s$	$C_{fw,s,HTO}$	Equation (F2)	Bq/m <sup>3</sup>	—
Conversion factor		1 000	L/m <sup>3</sup>	—
Activity concentrations of <sup>14</sup> C in fish calculated using:				
$C_{fish,s,^{14}C} = \frac{C_{fw,s,^{14}C} \cdot B_{fish,^{14}C}}{1000} \quad (F6)$				
Activity concentration of <sup>14</sup> C in freshwater fish (adapted from Equation (F3))	$C_{fish,s,^{14}C}$	Equation (F6)	Bq/kg	—
Activity concentration of <sup>14</sup> C in filtered water from river of size, $s$	$C_{fw,s,^{14}C}$	Equation (F2)	Bq/m <sup>3</sup>	—
Concentration factor for <sup>14</sup> C in freshwater fish	$B_{fish,^{14}C}$	$5 \times 10^4$	Bq/kg per Bq/L	[I5]
Conversion factor		1 000	L/m <sup>3</sup>	—
Deposition rate from irrigation calculated using				
$\dot{d}_{irr,s} = C_{uw,s} \cdot I_{irr} \cdot F_{irr} \quad (F7)$				
Total daily average deposition rate of radionuclide, $i$ , from irrigation	$\dot{d}_{irr,s}$	Equation (F7)	Bq/m <sup>2</sup>	—
Average concentration of radionuclide, $i$ , in river water used for irrigation	$C_{uw,s}$	Equation (F1)	Bq/m <sup>3</sup>	—
Daily irrigation rate	$I_{irr}$	0.005	m <sup>3</sup> /m <sup>2</sup>	[N2]
Fraction of the year for which irrigation occurs	$F_{irr}$	$\frac{150}{365} = 0.41$	—	[N2]

Parameter	Symbol	Value	Units	Reference
Activity concentration in terrestrial food (cereals, vegetables) calculated using:				
$C_{f,s,i} = \frac{C_{f,unit,i} \cdot \dot{d}_{irr,s}}{86\,400} \quad (F8)$				
Activity concentration of radionuclide, <i>i</i> , in irrigated, terrestrial food, <i>f</i>	$C_{f,s,i}$	Equation (F8)	Bq/kg	—
Activity concentration of radionuclide, <i>i</i> , in terrestrial food, <i>f</i> , per unit deposition rate	$C_{f,unit,i}$	PC-CREAM output	Bq/kg per Bq s/m <sup>2</sup>	—
Total daily average deposition rate of radionuclide, <i>i</i> , from irrigation	$\dot{d}_{irr,s}$	Equation (F7)	Bq/m <sup>2</sup>	—
Conversion factor		86 400	s/d	—
Activity concentration of HTO in soil water calculated using:				
$C_{sw,s,HTO} = \frac{I_{irr} \cdot C_{uw,s}}{P + 1\,000 \cdot I_{irr}} \quad (F9)$				
Activity concentration of HTO in soil water irrigated from river of size, <i>s</i>	$C_{sw,s,HTO}$	Equation (F9)	Bq/L	[I4]
Daily irrigation rate (averaged over 150-day growing season)	$I_{irr}$	0.005	m <sup>3</sup> /m <sup>2</sup>	[N2]
Average concentration of radionuclide, <i>i</i> , in river water used for irrigation	$C_{uw,s}$	Equation (F1)	Bq/m <sup>3</sup>	—
Daily precipitation rate (averaged over 150-day growing season)	<i>P</i>	5	L/m <sup>2</sup>	[U6]
Conversion factor		1 000	L/m <sup>3</sup>	—
HTO activity concentration in terrestrial food (cereals, vegetables) calculated using:				
$C_{f,s,HTO} = WC_p \cdot [RH \cdot C_{am} + (1 - RH) \cdot C_{sw,s,HTO}] / \gamma \quad (F10)$				
Activity concentration of HTO in food, <i>f</i>	$C_{f,s,HTO}$	Equation (F10)	Bq/kg	[I5]
Fractional water content of the plant	$WC_p$	Cereal: 0.12 Vegetables: 0.92	L/kg	[I5]
Relative humidity	RH	0.7	—	[I4]
HTO concentration in air moisture	$C_{am}$	Assumed approximately equal to $C_{sw,s,HTO}$	Bq/L	[I4]
Activity concentration of HTO in soil water	$C_{sw,s,HTO}$	Equation (F9)	Bq/L	—
Ratio of HTO vapour pressure to H <sub>2</sub> O vapour pressure	$\gamma$	0.909	—	[I5]
Activity concentration of OBT in terrestrial food (cereals, vegetables) calculated using:				
$C_{f,s,OBT} = (1 - WC_p) \cdot \frac{WEQ_p \cdot R_p \cdot C_{f,s,HTO}}{WC_p} \quad (F11)$				

Parameter	Symbol	Value	Units	Reference
Activity concentration of OBT in terrestrial food	$C_{f,s,OBT}$	Equation (F11)	Bq/kg	—
Fractional water content of plant (fresh weight)	$WC_p$	Cereal: 0.12 Vegetables: 0.92	L/kg	[I5]
Water equivalent factor for plant	$WEQ_p$	Cereal: 0.56 Vegetables: 0.51	L/kg	[I5]
Partition factor	$R_p$	0.54	—	[I5]
Activity concentration of HTO in food, $f$	$C_{f,s,HTO}$	Equation (F10)	Bq/kg	[I5]
Specific activity of $^{14}C$ in plant calculated using:				
$SA_p = SA_{air} = CD_c \cdot \frac{I_{irr} \cdot C_{uw,s}}{F_c} \quad (F12)$				
Specific activity of $^{14}C$ in plant	$SA_p$	Equation (F12)	Bq/(g C)	[I4]
Specific activity of $^{14}C$ in air	$SA_{air}$	Equation (F12)	Bq/(g C)	[I4]
Canopy dilution factor	$CD_c$	0.15	—	[I4]
Daily irrigation rate (averaged over growing season)	$I_{irr}$	0.005	$m^3/m^2$	[N2]
Activity concentration of dissolved radionuclide $i$ in unfiltered water	$C_{uw,s}$	Equation (F1)	Bq/ $m^3$	—
Average production rate of carbon by decomposition of crop residues	$F_c$	0.66	(g C)/ $m^2$	[I4]
$^{14}C$ activity concentration in terrestrial food (cereals, vegetables) calculated using:				
$C_{f,s,^{14}C} = \frac{C_{air,^{14}C}}{S_{air}} \cdot S_p = SA_{air} \cdot S_p \quad (F13)$				
$^{14}C$ activity concentration in food, $f$ , irrigated from river of size, $s$	$C_{f,s,^{14}C}$	Equation (F13)	Bq/kg	[I4]
Specific activity of $^{14}C$ in air	$SA_{air}$	Equation (F12)	Bq/(g C)	[I4]
Concentration of stable carbon in the plant	$S_p$	Cereal: $3.9 \times 10^2$ Vegetables: 30	(g C)/kg	[I5]
INDIVIDUAL DOSE CALCULATIONS				
Individual dose from ingestion of drinking water calculated using				
$H_{E(water),s,i} = C_{uw,s} \cdot D_{ing,i} \cdot I_{water} \cdot F_{WT} \cdot P_{river} \quad (F14)$				
Annual effective dose from the ingestion of radionuclide, $i$ , in drinking water	$H_{E(water),s,i}$	Equation (F14)	Sv	—
Average activity concentration of radionuclide, $i$ , in water assuming complete mixing	$C_{uw,s}$	Equation (F1)	Bq/ $m^3$	—

Parameter	Symbol	Value	Units	Reference
Dose coefficient for ingestion of radionuclide, $i$	$D_{\text{ing},i}$	Dependent on radionuclide	Sv/Bq	[I14]
Amount of water ingested in one year	$I_{\text{water}}$	0.5	m <sup>3</sup>	[U6]
Drinking water treatment removal factor	$F_{\text{WT}}$	Dependent on element	—	[B7]
Fraction of individual water intake from river	$P_{\text{river}}$	1	—	—
Dose from external exposure from freshwater sediments calculated using:				
$H_{E(\text{ex,riverbank}),s,i} = C_{\text{sed},s,i} \cdot \rho_{\text{sed}} \cdot t_{\text{sed}} \cdot F_{\text{geom}} \cdot D_{\text{ex,deposit}} \cdot O_{\text{riverbank}} \quad (\text{F15})$				
Annual effective dose from radionuclide, $i$ , from occupancy on river banks	$H_{E(\text{ex,riverbank}),s,i}$	Equation (F15)	Sv	—
Activity concentration of radionuclide, $i$ , in freshwater riverbank sediment based on discharge rate of 1 Bq/s (assumed to be the same as bed sediment) (dry weight)	$C_{\text{sed},s,i}$	PC-CREAM output	Bq/kg	—
Density of riverbank sediment	$\rho_{\text{sed}}$	1 200	kg/m <sup>3</sup>	[I2]
Thickness of riverbank sediment	$t_{\text{sed}}$	0.05	m	[I2]
Geometry factor for river banks for external dose coefficients	$F_{\text{geom}}$	0.2 (rounded)	—	[A2]
Integrated dose coefficient for irradiation from surface deposits	$D_{\text{ex,deposit}}$	Dependent on radionuclide	Sv/s per Bq/m <sup>2</sup>	[E2]
River bank occupancy	$O_{\text{riverbank}}$	$1.8 \times 10^5$ (50 hours)	s	Assumed value
Ingestion of freshwater fish				
$H_{E(\text{ing,fish}),s,r,i} = C_{\text{fish},s,i} \cdot D_{\text{ing},i} \cdot F_{\text{local}} \cdot I_{\text{fish},r} \quad (\text{F16})$				
Annual effective dose from radionuclide, $i$ , from ingestion of freshwater fish in region, $r$	$H_{E(\text{ing,fish}),s,r,i}$	Equation (F16)	Sv	—
Average activity concentration of radionuclide, $i$ , in freshwater fish	$C_{\text{fish},s,i}$	Equations (F3), (F4), (F5), (F6)	Bq/kg	—
Dose coefficient for adults for ingestion	$D_{\text{ing},i}$	Dependent on radionuclide	Sv/Bq	[I14]
Fraction of food that is locally produced	$F_{\text{local}}$	0.25	—	See para.11 [U12]
Amount of freshwater fish ingested in a year in region, $r$	$I_{\text{fish},r}$	Dependent on region	kg	[F3]
Dose from ingestion of irrigated, terrestrial foods calculated using:				
$H_{E(\text{ing,irr}),f,s,r,i} = C_{f,s,i} \cdot D_{\text{ing},i} \cdot F_{\text{local}} \cdot F_{\text{spray},s,r} \cdot I_{f,r} \quad (\text{F17})$				
Annual effective dose from the ingestion of irrigated, terrestrial food, $f$ , containing radionuclide, $i$ , in region, $r$	$H_{E(\text{ing,irr}),f,s,r,i}$	Equation (F17)	Sv	—

Parameter	Symbol	Value	Units	Reference
Activity concentration of radionuclide, <i>i</i> , in irrigated, terrestrial food, <i>f</i>	$C_{f,s,i}$	Equations (F8), (F10), (F11), (F13)	Bq/kg	—
Adult dose coefficient for ingestion	$D_{\text{ing},i}$	Dependent on radionuclide	Sv/Bq	[114]
Fraction of food that is locally produced	$F_{\text{local}}$	0.25	—	See para. 11 [U12]
Fraction of food that is spray irrigated	$F_{\text{spray},s,r}$	Small rivers: 0 Large rivers: dependent on region	—	[17]
Amount of food, <i>f</i> , ingested in a year in region, <i>r</i>	$I_{f,r}$	Dependent on region and food	kg	[W2]
Total effective dose from ingestion of irrigated, terrestrial foods calculated using:				
		$H_{E(\text{ing,irr}),s,r,i} = \sum_f H_{E(\text{ing,irr}),f,s,r,i}$		(F18)
Total effective dose in region, <i>r</i> , from ingestion of irrigated, terrestrial food containing radionuclide, <i>i</i>	$H_{E(\text{ing,irr}),s,r,i}$	Equation (F18)	Sv	—
Annual effective dose from the ingestion of irrigated, terrestrial food, <i>f</i> , containing radionuclide <i>i</i> in region, <i>r</i>	$H_{E(\text{ing,irr}),f,s,r,i}$	Equation (F17)	Sv	—
Total individual dose from freshwater pathways calculated using:				
		$H_{E(\text{fw}),s,r,i} = H_{E(\text{water}),s,i} + H_{E(\text{ex,riverbank}),s,i} + H_{E(\text{fish}),s,r,i} + H_{E(\text{ing,irr}),s,r,i}$		(F19)
Total individual dose from freshwater pathways	$H_{E(\text{fw}),s,r,i}$	Equation (F19)	Sv	—
Annual effective dose from the ingestion of radionuclide, <i>i</i> , in drinking water	$H_{E(\text{water}),s,i}$	Equation (F14)	Sv	—
Annual effective dose from radionuclide, <i>i</i> , from occupancy on river banks	$H_{E(\text{ex,riverbank}),s,i}$	Equation (F15)	Sv	—
Annual effective dose from radionuclide, <i>i</i> , from ingestion of freshwater fish in region, <i>r</i>	$H_{E(\text{fish}),s,r,i}$	Equation (F16)	Sv	—
Total effective dose in region, <i>r</i> , from ingestion of irrigated, terrestrial food containing radionuclide, <i>i</i>	$H_{E(\text{ing,irr}),s,r,i}$	Equation (F18)	Sv	—
<b>COLLECTIVE DOSE CALCULATIONS</b>				
Volumetric abstraction rate of water calculated using:				
		$V_{\text{irr,surface},s,r} = F_{\text{river},s} \cdot F_{\text{irr,surface},r}$		(F20)
Volumetric abstraction rate of surface water from river of size, <i>s</i> , in region, <i>r</i>	$V_{\text{irr,surface},s,r}$	Equation (F20)	m <sup>3</sup> /s	—
Volumetric flow rate of river of size, <i>s</i>	$F_{\text{river},s}$	Large: 1 000 Small: 10	m <sup>3</sup> /s	—
Fraction of surface water withdrawn for irrigation in region, <i>r</i>	$F_{\text{irr,surface},r}$	Dependent on region	m <sup>2</sup> a/m <sup>3</sup>	[F4]



Parameter	Symbol	Value	Units	Reference
Area irrigated by abstracted water calculated using:				
$A_{\text{irr,surface},s,r} = 3.15 \times 10^7 \cdot A_{\text{irr,unit},r} \cdot V_{\text{irr,surface},s,r} \quad (\text{F21})$				
Area irrigated by water abstracted from river of size, $s$ , in region, $r$	$A_{\text{irr,surface},s,r}$	Equation (F21)	m <sup>2</sup>	—
Area irrigated per unit volume water withdrawn in a year in region, $r$	$A_{\text{irr,unit},r}$	Dependent on region	m <sup>2</sup> a/m <sup>3</sup>	[F4]
Volumetric abstraction rate of surface water from river of size, $s$ , in region, $r$	$V_{\text{irr,surface},s,r}$	Equation (F20)	m <sup>3</sup> /s	—
Conversion factor		$3.15 \times 10^7$ (rounded)	s/a	
Irrigation rate calculated using:				
$\dot{d}_{\text{irr,surface},s,r} = \frac{C_{\text{uw},s} \cdot V_{\text{irr,surface},s,r}}{A_{\text{irr,surface},s,r}} \quad (\text{F22})$				
Irrigation rate, assumed to be the same volume of water with the same activity concentration abstracted from river of size, $s$ , in region, $r$	$\dot{d}_{\text{irr,surface},s,r}$	Equation (F22)	Bq s/m <sup>2</sup>	—
Activity concentration in unfiltered water	$C_{\text{uw},s}$	Equation (F1)	Bq/m <sup>3</sup>	—
Volumetric abstraction rate of surface water from river of size, $s$ , in region, $r$	$V_{\text{irr,surface},s,r}$	Equation (F20)	m <sup>3</sup> /s	—
Area irrigated by water abstracted from river of size, $s$ , in region, $r$	$A_{\text{irr,surface},s,r}$	Equation (F21)	m <sup>2</sup>	—
Activity concentration in irrigated, terrestrial foods calculated using:				
$C_{\text{cereal},s,r,i} = C_{\text{cereal,unit},i} \cdot \dot{d}_{\text{irr,surface},s,r} \quad (\text{F23})$				
Activity concentration of radionuclide, $i$ , in terrestrial food (represented by cereal) irrigated from river of size, $s$ , in region, $r$	$C_{\text{cereal},s,r,i}$	Equation (F23)	Bq/kg	—
Activity concentration of radionuclide, $i$ , in terrestrial food, $f$ , per unit deposition rate	$C_{\text{cereal,unit},i}$	PC-CREAM output	Bq/kg per Bq s/m <sup>2</sup>	
Irrigation rate	$\dot{d}_{\text{irr,surface},s,r}$	Equation (F22)	Bq s/m <sup>2</sup>	—
Activity concentration of <sup>14</sup> C in cereals calculated using:				
$\begin{aligned} C_{\text{cereal},s,r,^{14}\text{C}} &= \frac{C_{\text{air},^{14}\text{C}}}{S_{\text{air}}} \cdot S_p = SA_{\text{air}} \\ &= CD_c \cdot \frac{C_{\text{uw},s}}{365 \cdot A_{\text{irr,unit},r} \cdot F_c} \cdot S_p \end{aligned} \quad (\text{F24})$				
Activity concentration of <sup>14</sup> C in food, $f$ , irrigated from river of size, $s$	$C_{\text{cereal},s,r,^{14}\text{C}}$	Equation (F24)	Bq/kg	Equations (F13) & (F12)
Canopy dilution factor	$CD_c$	0.15	—	[I4]

Parameter	Symbol	Value	Units	Reference
Activity concentration in unfiltered water	$C_{uw,s}$	Equation (F1)	Bq/m <sup>3</sup>	—
Area irrigated per unit volume in region, $r$	$A_{irr,unit,r}$	Dependent on region	m <sup>2</sup> a/m <sup>3</sup>	[F4]
Average daily production rate of carbon by decomposition of crop residues	$F_c$	0.66	(g C)/m <sup>2</sup>	[I4]
Concentration of stable carbon in the plant	$S_p$	$3.9 \times 10^2$	(g C)/kg	[I5]
Conversion factor		365	d/a	—
Collective dose from ingestion of irrigated, terrestrial food calculated using:				
$S_{E(ing,irr),s,r,i} = C_{cereal,s,r,i} \cdot Y_{cereal,r} \cdot F_{spray,s,r} \cdot A_{irr,surface,s,r} \cdot D_{ing,i} \quad (F25)$				
Collective dose from consumption of food (represented by major food group, cereal) in region, $r$	$S_{E(ing,irr),s,r,i}$	Equation (F25)	man Sv	—
Activity concentration of radionuclide, $i$ , in terrestrial food (represented by cereal) irrigated from river of size, $s$ , in region, $r$	$C_{cereal,s,r,i}$	Equations (F23), (F10), (F11), (F24)	Bq/kg	—
Yield per unit area of cereal in region, $r$	$Y_{cereal,r}$	Dependent on region	kg/m <sup>3</sup>	[F1]
Fraction of food that is spray irrigated	$F_{spray,s,r}$	Small rivers: 0 Large rivers: dependent on region	—	[I7]
Area irrigated by water abstracted from river of size, $s$ , in region, $r$	$A_{irr,surface,s,r}$	Equation (F21)	m <sup>2</sup>	—
Adult dose coefficient for ingestion	$D_{ing,i}$	Dependent on radionuclide	Sv/Bq	[I14]
Collective dose from drinking water calculated using:				
$S_{E(water),s,i} = C_{uw,i} \cdot D_{ing,i} \cdot F_{river,s} \cdot T_{dw} \cdot A_{mun} \cdot F_{dw} \cdot F_{WT} \quad (F26)$				
Collective dose from drinking water for river of size, $s$	$S_{E(water),s,i}$	Equation (F26)	man Sv	—
Activity concentration of dissolved radionuclide, $i$ , in unfiltered water	$C_{uw,i}$	Equation (F1)	Bq/m <sup>3</sup>	—
Dose coefficient for ingestion of radionuclide, $i$	$D_{ing,i}$	Dependent on radionuclide	Sv/q	[I14]
Volumetric flow rate of river of size, $s$	$F_{river,s}$	Large: 1 000 Small: 10	m <sup>3</sup> /s	—
Duration of abstraction	$T_{dw}$	$3.15 \times 10^7$ (rounded)	S	—
Abstraction fraction for municipal water	$A_{mun}$	0.01	—	—
Fraction of municipal water that is drunk	$F_{dw}$	0.01	—	—
Drinking water treatment removal factor	$F_{WT}$	Dependent on element	—	[B7]

Parameter	Symbol	Value	Units	Reference
Collective dose from freshwater fish ingestion calculated using:				
$S_{E(\text{ing, fish}), s, i} = C_{\text{fish}, s, i} \cdot D_{\text{ing}, i} \cdot Y_{\text{fish}, s} \cdot L_{\text{river}, s}$ (F27)				
Collective dose from ingestion of freshwater fish from river of size, $s$	$S_{E(\text{ing, fish}), s, i}$	Equation (F27)	man Sv	—
Activity concentration of radionuclide, $i$ , in filtered water from river of size, $s$	$C_{\text{fish}, s, i}$	Equations (F3), (F4), (F5), (F6)	Bq/m <sup>3</sup>	—
Dose coefficient for ingestion of radionuclide, $i$	$D_{\text{ing}, i}$	Dependent on radionuclide	Sv/Bq	[114]
Representative freshwater fish catch in river of size, $s$	$Y_{\text{fish}, s}$	Large: $10^4$ Small: $10^3$	kg/km	[F1]
Length of river of size, $s$	$L_{\text{river}, s}$	Large: $5 \times 10^2$ Small: $1 \times 10^2$	km	[I2]
Total collective dose from all freshwater pathways calculated using:				
$S_{E(\text{fw}), s, r, i} = S_{E(\text{ing, irr}), s, r, i} + S_{E(\text{water}), s, i} + S_{E(\text{ing, fish}), s, i}$ (F28)				
Total collective dose in region, $r$ , from discharges into river of size, $s$	$S_{E(\text{fw}), s, r, i}$	Equation (F28)	man Sv	—
Collective dose from consumption of food (represented by major food group, cereal) in region, $r$	$S_{E(\text{ing, irr}), s, r, i}$	Equation (F25)	man Sv	—
Collective dose from drinking water for river of size, $s$	$S_{E(\text{water}), s, i}$	Equation (F26)	man Sv	—
Collective dose from ingestion of freshwater fish of size, $s$	$S_{E(\text{ing, fish}), s, i}$ $S_{E(\text{fish}), s, i}$	Equation (F27)	man Sv	—
GLOBAL DISPERSION				
Collective doses from tritium, <sup>14</sup> C, <sup>85</sup> Kr and <sup>129</sup> I were calculated by PC-CREAM (incorporates global dispersion models referenced in [U6])				

Table A4. Parameter and equation list: Marine environment

Parameter	Symbol	Value	Units	Reference
MARINE DISPERSION				
Sedimentation decay constant				
$\lambda_{s,c,i} = \frac{K_{d,c,i} \cdot S_c}{h_c \cdot (1 + K_{d,c,i} \cdot \alpha_c)}$				(M38)
Sedimentation decay constant for compartment, <i>c</i>	$\lambda_{s,c,i}$	Equation (M38)	a <sup>-1</sup>	[C2]
Marine sediment distribution factor for compartment <i>c</i> and radionuclide, <i>i</i>	$K_{d,c,i}$	Dependent on radionuclide	m <sup>3</sup> t <sup>-1</sup>	[I3]
Sedimentation rate in compartment, <i>c</i>	$S_c$	Local: 1.0 × 10 <sup>-4</sup> Regional: 1.0 × 10 <sup>-5</sup>	t m <sup>-2</sup> a <sup>-1</sup>	(see section III.C of main text)
Depth of compartment, <i>c</i>	$h_c$	Local: 10 Regional: 1000	m	(see section III.C of main text)
Suspended sediment load in compartment, <i>c</i>	$\alpha_c$	Local: 2.0 × 10 <sup>-4</sup> Regional: 1.0 × 10 <sup>-7</sup>	t m <sup>-3</sup>	(see section III.C of main text)
Flow rate constant, local to regional				
$\lambda_{l,r} = \frac{\Delta V_{l,r}}{V_l}$				(M39)
Flow rate constant, local compartment to regional compartment	$\lambda_{l,r}$	Equation (M39)	a <sup>-1</sup>	(see section III.C of main text)
Volumetric exchange between regional compartment and global oceans	$\Delta V_{l,r}$	2 × 10 <sup>10</sup>	m <sup>3</sup> a <sup>-1</sup>	(see section III.C of main text)
Volume of local compartment	$V_l$	10 <sup>9</sup>	m <sup>3</sup>	(see section III.C of main text)
Flow rate constant, regional compartment to global oceans				
$\lambda_{r,g} = \frac{\Delta V_{r,g}}{V_r}$				(M40)
Flow rate constant, regional compartment to global oceans	$\lambda_{r,g}$	Equation (M40)	a <sup>-1</sup>	(see section III.C of main text)
Volumetric exchange between local and regional compartments	$\Delta V_{r,g}$	10 <sup>15</sup>	m <sup>3</sup> a <sup>-1</sup>	(see section III.C of main text)
Volume of regional compartment	$V_r$	10 <sup>15</sup>	m <sup>3</sup>	(see section III.C of main text)
Combined decay constant, local to regional				
$\Lambda_{l,i} = \lambda_i + \lambda_{s,l,i} + \lambda_{l,r}$				(M41)
Combined decay constant for local compartment and radionuclide, <i>i</i>	$\Lambda_{l,i}$	Equation (M41)	a <sup>-1</sup>	[C2]

Parameter	Symbol	Value	Units	Reference
Radioactive decay constant for radionuclide, $i$	$\lambda_i$	Dependent on radionuclide	a <sup>-1</sup>	[I9]
Sedimentation decay constant for local compartment	$\lambda_{s,li}$	Equation (M38)	a <sup>-1</sup>	[C2]
Flow rate constant, local compartment to regional compartment	$\lambda_{lr}$	Equation (M39)	a <sup>-1</sup>	(see section III.C of main text)
Combined decay constant, regional compartment to global oceans $\Lambda_{r,i} = \lambda_i + \lambda_{s,r,i} + \lambda_{r,g}$ (M42)				
Combined decay constant for regional compartment and radionuclide, $i$	$\Lambda_{r,i}$	Equation (M42)	a <sup>-1</sup>	[C2]
Radioactive decay constant for radionuclide, $i$	$\lambda_i$	Dependent on radionuclide	a <sup>-1</sup>	[I9]
Sedimentation decay constant for regional compartment	$\lambda_{s,ri}$	Equation (M38)	a <sup>-1</sup>	[C2]
Flow rate constant, regional compartment to global oceans	$\lambda_{rg}$	Equation (M40)	a <sup>-1</sup>	(see section III.C of main text)
Activity in local compartment $A_{l,i}(t) = \frac{Q}{\Lambda_{l,r}}(1 - e^{-\Lambda_{l,r}t})$ (M43)				
Activity of radionuclide, $i$ , in local compartment at time, $t$	$A_{l,i}(t)$	Equation (M43)	Bq	[C2]
Discharge rate	$Q$	$3.15 \times 10^7$ (rounded)	Bq a <sup>-1</sup>	= 1 Bq s <sup>-1</sup>
Combined decay constant for local compartment and radionuclide, $i$	$\Lambda_{l,r}$	Equation (M41)	a <sup>-1</sup>	[C2]
Duration of discharge	$t$	100	a	—
Activity in regional compartment $A_{r,i}(t) = \frac{\lambda_{lr} \cdot A_{l,i}(t)}{\Lambda_{l,r}}(1 - e^{-\Lambda_{l,r}t})$ (M44)				
Activity of radionuclide, $i$ , in regional compartment at time, $t$	$A_{r,i}(t)$	Equation (M44)	Bq	[C2]
Rate constant for movement of water from local compartment to regional compartment	$\lambda_{lr}$	20	a <sup>-1</sup>	(see section III.C of main text)
Activity of radionuclide, $i$ , in local compartment at time, $t$	$A_{l,i}(t)$	Equation (M43)	Bq	[C2]
Combined decay constant for regional compartment and radionuclide, $i$	$\Lambda_{l,r}$	Equation (M41)	a <sup>-1</sup>	[C2]
Duration of discharge	$t$	100	a	—

Parameter	Symbol	Value	Units	Reference
Activity concentration in water				
		$C_{c,i}(t) = \frac{A_{c,i}(t)}{V_c}$		(M45)
Activity concentration of radionuclide, <i>i</i> , in water in compartment, <i>c</i> , at time, <i>t</i>	$C_{c,i}(t)$	Equation (M45)	Bq m <sup>-3</sup>	—
Activity of radionuclide, <i>i</i> , in compartment, <i>c</i> , at time, <i>t</i>	$A_{c,i}(t)$	Equations (M43), (M44)	Bq	[C2]
Volume of compartment, <i>c</i>	$V_c$	Local: $1.0 \times 10^9$ Regional: $1.0 \times 10^{15}$	m <sup>3</sup>	(see section III.C of main text)
ENVIRONMENTAL TRANSFERS				
Activity concentrations in marine foods				
		$C_{f,e,i} = \frac{C_{c,i} \cdot B_{f,i}}{1000}$		(M46)
Activity concentration of radionuclide, <i>i</i> , in marine food, <i>f</i> , in compartment, <i>c</i>	$C_{f,e,i}$	Equation (M46)	Bq kg <sup>-1</sup>	—
Activity concentration of radionuclide, <i>i</i> , in water at time, <i>t</i>	$C_{c,i}$	Equation (M45)	Bq m <sup>-3</sup>	—
Bioaccumulation factor for marine food, <i>f</i> , concentration in marine food (fresh weight) divided by concentration in seawater	$B_{f,i}$	Dependent on food and element	L kg <sup>-1</sup>	[I3]
Conversion factor		1 000	L m <sup>-3</sup>	—
Activity concentration in beach sediment				
		$C_{\text{beach},i} = 0.1 \cdot t_{\text{sed}} \cdot \rho_{\text{sed}} \cdot K_{d,\text{local},i} \cdot C_{\text{local},i}$		(M47)
Activity concentration per unit area in beach sediment	$C_{\text{beach},i}$	Equation (M47)	Bq m <sup>-2</sup>	—
$K_d$ adjustment factor for coarser grains (i.e. sand rather than fine bed sediment)	—	0.1	—	[S7]
Average thickness of beach sediment	$t_{\text{sed}}$	0.05	m	[I2]
Average density of beach sediment	$\rho_{\text{sed}}$	1.2	t m <sup>-3</sup>	[I2]
Marine sediment distribution factor in local compartment for radionuclide, <i>i</i>	$K_{d,\text{local},i}$	Dependent on radionuclide	m <sup>3</sup> t <sup>-1</sup> (L kg <sup>-1</sup> )	[I3]
Activity concentration of radionuclide, <i>i</i> , in water	$C_{\text{local},i}$	Equation (M45)	Bq m <sup>-3</sup>	—
INDIVIDUAL DOSE CALCULATIONS				
External dose from beach occupancy				
		$H_{E(\text{ex.beach}),i} = C_{\text{beach},i} \cdot F_{\text{geom}} \cdot D_{\text{ex.deposit},i} \cdot O_{\text{beach}}$		(M48)

Parameter	Symbol	Value	Units	Reference
Effective dose from radionuclide, $i$ , from beach occupancy	$H_{E(\text{ex.beach}),i}$	Equation (M48)	Sv	—
Activity concentration of radionuclide, $i$ , in beach sediment	$C_{\text{beach},i}$	Equation (M47)	Bq m <sup>-2</sup>	—
Geometry factor for beaches for external dose coefficients	$F_{\text{geom}}$	0.5	—	[E2]
Dose coefficient for irradiation from surface deposits	$D_{\text{ex,deposit},i}$	Dependent on radionuclide	Sv s <sup>-1</sup> Bq <sup>-1</sup> m <sup>2</sup>	[E2]
Beach occupancy (typical rather than critical)	$O_{\text{beach}}$	$3.6 \times 10^5$	s	[R1]
Ingestion of marine food				
$H_{E(\text{ing.marine}),f,r,i} = (C_{f,\text{local},i} \cdot f_{f,\text{local}} + C_{f,\text{regional},i} \cdot f_{f,\text{regional}}) \cdot D_{\text{ing},i} \cdot I_{f,r}$				(M49)
Annual effective dose from radionuclide, $i$ , from ingestion of freshwater fish in region, $r$	$H_{E(\text{ing.marine}),f,r,i}$	Equation (M49)	Sv	—
Average activity concentration of radionuclide, $i$ , in food, $f$ , in the local marine compartment	$C_{f,\text{local},i}$	Equation (M46)	Bq kg <sup>-1</sup>	—
Fraction of food, $f$ , that is caught in the local marine compartment	$f_{f,\text{local}}$	Fish: 0.25 Crustaceans: 1.0 Molluscs: 1.0	—	Fish: consistent with freshwater and terrestrial Crustaceans and molluscs: [S7]
Average activity concentration of radionuclide, $i$ , in food, $f$ , in the regional marine compartment	$C_{f,\text{regional},i}$	Equation (M46)	Bq kg <sup>-1</sup>	—
Fraction of food, $f$ , that is caught in the regional marine compartment	$f_{f,\text{regional}}$	Fish: 0.75 Crustaceans: 0.0 Molluscs: 0.0	—	Fish: consistent with freshwater and terrestrial environments Crustaceans & molluscs: [S7]
Adult dose coefficient for ingestion	$D_{\text{ing},i}$	Dependent on radionuclide	Sv Bq <sup>-1</sup>	[I14]
Amount of marine food, $f$ , ingested in a year in region, $r$	$I_{f,r}$	Dependent on region	kg	[W2]
Total effective dose from ingestion of marine foods				
$H_{E(\text{ing.marine}),r,i} = \sum_f H_{E(\text{ing.marine}),f,r,i}$				(M50)
Total effective dose in region, $r$ , from ingestion of marine food containing radionuclide, $i$	$H_{E(\text{ing.marine}),r,i}$	Equation (M50)	Sv	—
Effective dose from the ingestion of marine food $f$ containing radionuclide, $i$ , in region, $r$	$H_{E(\text{ing.marine}),f,r,i}$	Equation (M49)	Sv	—

Parameter	Symbol	Value	Units	Reference
Total individual dose from marine pathways				
$H_{E(\text{marine}),r,i} = H_{E(\text{ex.beach}),i} + H_{E(\text{ing.marine}),r,i}$				(M51)
Total individual dose from marine pathways in region, $r$	$H_{E(\text{marine}),r,i}$	Equation (M51)	Sv	—
Effective dose from beach occupancy	$H_{E(\text{ex.beach}),i}$	Equation (M48)	Sv	—
Effective dose from the ingestion of radionuclide, $i$ , in marine foods in region, $r$	$H_{E(\text{ing.marine}),r,i}$	Equation (M50)	Sv	—
COLLECTIVE DOSE CALCULATIONS				
Collective dose from ingestion of marine fish				
$S_{E(\text{ing.marine}),\text{fish},c,r,i} = C_{\text{fish},c,i} \cdot Y_{\text{fish},r} \cdot F_{\text{ed, fish}} \cdot A_c \cdot D_{\text{ing},i}$				(M52)
Collective dose from ingestion of marine fish for radionuclide, $i$	$S_{E(\text{ing.marine}),\text{fish}}$	Equation (M52)	man Sv	—
Activity concentration of radionuclide, $i$ , in fish in compartment, $c$	$C_{\text{fish},c,i}$	Equation (M46)	Bq kg <sup>-1</sup>	—
Fish catch in 1 year in region, $r$	$Y_{\text{fish},r}$	Dependent on region	kg km <sup>-2</sup>	[F2]
Edible fraction of catch	$F_{\text{ed, fish}}$	0.5	—	[S6]
Area of compartment, $c$	$A_c$	Local: $1 \times 10^2$ Regional: $1 \times 10^6$	km <sup>2</sup>	(see section III.C of main text)
Adults dose coefficient for ingestion	$D_{\text{ing},i}$	Dependent on radionuclide	Sv Bq <sup>-1</sup>	[I14]
Collective dose from ingestion of shellfish				
$S_{E(\text{ing.marine}),f,c,r,i} = C_{f,c,i} \cdot Y_{f,r} \cdot F_{\text{ed},f} \cdot L_c \cdot D_{\text{ing},i}$				(M53)
Collective dose from ingestion of marine food, $f$ , (where $f \in \{\text{molluscs, crustaceans}\}$ ) in compartment, $c$ , for radionuclide, $i$	$S_{E(\text{ing.marine}),f,c}$	Equation (M53)	man Sv	—
Activity concentration of radionuclide, $i$ , in marine food, $f$ , in compartment, $c$	$C_{f,c,i}$	Equation (M46)	Bq kg <sup>-1</sup>	—
Harvest of marine food, $f$ , in 1 year per unit length of coastline in region, $r$	$Y_{f,r}$	Dependent on region	kg km <sup>-1</sup>	[F2]
Edible fraction of catch for marine food, $f$	$F_{\text{ed},f}$	Crustaceans: 0.35 Molluscs: 0.15	—	[S6]
Length of coastline in compartment, $c$	$L_c$	Local: 10 Regional: 1 000	km	(see section III.C of main text)
Adults dose coefficient for ingestion	$D_{\text{ing},i}$	Dependent on radionuclide	Sv Bq <sup>-1</sup>	[I14]



<i>Parameter</i>	<i>Symbol</i>	<i>Value</i>	<i>Units</i>	<i>Reference</i>
Total collective dose from all marine pathways	$S_{E(\text{marine}),c,r,i} = \sum_f S_{E(\text{ing,marine}),f,c,r,i}$			(M54)
Total collective dose in compartment, <i>c</i>	$S_{E(\text{marine}),c,r,i}$	Equation (M54)	man Sv	—
Collective dose from consumption of food, <i>f</i> , in compartment, <i>c</i>	$S_{E(\text{ing,marine}),f,c}$	Equations (M52) and (M53)	man Sv	—
GLOBAL DISPERSION				
Collective doses from tritium, <sup>14</sup> C, <sup>85</sup> Kr and <sup>129</sup> I calculated by PC-CREAM (incorporates global dispersion models referenced in UNSCEAR 2000 Report [U6])				

Table A5. Treatment of progeny for atmospheric and terrestrial pathways

Half-lives are given in brackets to two significant figures [I9]

Discharged parent	Progeny	Exposure pathway		
		Plume (external irradiation and inhalation)	Deposited material (external irradiation)	Food (ingestion)
<sup>90</sup> Sr (29 a)	<sup>90</sup> Y (64 h)	Dose coefficient for inhalation of parent accounts for progeny. Activity concentration of progeny assumed equal to parent for estimating external exposure	Deposition and dose rates calculated for parent and progeny separately	Dose coefficient for ingestion of parent accounts for progeny
<sup>106</sup> Ru (370 d)	<sup>106</sup> Rh (30 s)	Secular equilibrium assumed. Dose rates calculated for both parent and progeny	Deposition and dose rates calculated for parent and progeny separately	Dose coefficient for ingestion of parent accounts for progeny
<sup>135</sup> Xe (9.1h)	<sup>135</sup> Cs (2.3 × 10 <sup>6</sup> a)	Activity concentrations of progeny in air calculated explicitly based on transit time	Deposition and dose rate calculated for progeny	Activity concentration calculated from deposition rate for progeny
<sup>138</sup> Xe (14 m)	<sup>138</sup> Cs (32 min)	Activity concentration of progeny in air calculated explicitly based on transit time	Deposition and dose rate calculated for progeny	Activity concentration calculated from deposition rate for progeny
<sup>137</sup> Cs (30 a)	<sup>137m</sup> Ba (2.6 min)	Dose coefficient for inhalation of parent accounts for progeny. Activity concentration of progeny calculated at yield of 94.6% for estimating external exposure	Deposition and dose rates calculated for parent and progeny separately	Dose coefficient for ingestion of parent accounts for progeny
<sup>210</sup> Pb (22 a)	<sup>210</sup> Bi (5.0 d) <sup>210</sup> Po (140 d)	Ingrowth insignificant during plume transit; progeny not considered	Negligible dose from progeny following ingrowth after deposition of <sup>210</sup> Pb; not considered	Ingrowth following deposition of <sup>210</sup> Pb to soil and plant, but activity concentration of <sup>210</sup> Po in terrestrial foods significantly lower than for deposition of <sup>210</sup> Po; subsequent small doses compared to those from <sup>210</sup> Pb; ingrowth not considered
<sup>222</sup> Rn (3.8 d)	<sup>218</sup> Po (3.1 min) <sup>214</sup> Pb (27 min) <sup>214</sup> Bi (20 min) <sup>214</sup> Po (164 μs) <sup>210</sup> Pb (22 a) <sup>210</sup> Bi (5.0 d) <sup>210</sup> Po (140 d)	Dose coefficient for inhalation of <sup>222</sup> Rn includes contribution from four immediate short-lived progeny [U9]. Longer lived progeny ( <sup>210</sup> Pb, <sup>210</sup> Bi and <sup>210</sup> Po) will not grow in during plume transit and so not considered	Negligible contributions to dose from deposition of progeny compared with dose from inhalation; not considered	Because of time taken for ingrowth and reduced activities of long-lived progeny compared to <sup>222</sup> Rn, negligible doses from ingestion of progeny in terrestrial foods; not considered

Discharged parent	Progeny	Exposure pathway		
		Plume (external irradiation and inhalation)	Deposited material (external irradiation)	Food (ingestion)
$^{226}\text{Ra}$ (1 600 a)	$^{222}\text{Rn}$ (3.8 d) $^{218}\text{Po}$ (3.1 min) $^{214}\text{Pb}$ (27 min) $^{214}\text{Bi}$ (20 min) $^{214}\text{Po}$ (164 $\mu\text{s}$ ) $^{210}\text{Pb}$ (22a) $^{210}\text{Bi}$ (5.0 d) $^{210}\text{Po}$ (140 d)	Ingrowth insignificant during plume transit; progeny not considered	Ingrowth following deposition of $^{226}\text{Ra}$ , but radon gas largely emitted to atmosphere and further diluted. Small doses from progeny compared with parent; not included	Ingrowth following deposition of $^{226}\text{Ra}$ , but radon gas largely emitted to atmosphere and further diluted. Small doses from progeny compared with parent; not included
$^{232}\text{Th}$ ( $1.4 \times 10^{10}$ a)	$^{228}\text{Ra}$ (5.8 a) $^{228}\text{Ac}$ (6.1 h) $^{228}\text{Th}$ (1.9 a) $^{212}\text{Pb}$ (11 h)	Secular equilibrium assumed; activity concentration in air assumed equal to parent	Deposition rate calculated for each progeny in secular equilibrium	Activity concentration of parent in air used as proxy for secular equilibrium in soil after 100 years. Only $^{228}\text{Ra}$ , $^{228}\text{Th}$ and $^{212}\text{Pb}$ included
$^{234}\text{U}$ ( $2.4 \times 10^5$ a)	$^{230}\text{Th}$ ( $7.7 \times 10^4$ a)	Parent half-life sufficiently long that ingrowth not relevant at 100 years		
$^{238}\text{U}$ ( $4.5 \times 10^9$ a)	$^{234}\text{Th}$ (24 d) $^{234\text{m}}\text{Pa}$ (1.2 min)	Secular equilibrium assumed; activity concentration in air assumed equal to parent	Deposition rate calculated for each progeny	Activity concentration of parent in air used as proxy for secular equilibrium in soil after 100 years. Only $^{234}\text{Th}$ included
$^{239}\text{Pu}$ ( $2.4 \times 10^4$ a)	$^{235}\text{U}$ ( $7.0 \times 10^8$ a)	Parent half-life sufficiently long that ingrowth not relevant at 100 years		
$^{240}\text{Pu}$ (6 500 a)	$^{236}\text{U}$ ( $2.3 \times 10^7$ a)			
$^{241}\text{Am}$ (430 a)	$^{237}\text{Np}$ ( $2.1 \times 10^6$ a)			

Table A6. Treatment of progeny for freshwater pathways

Half-lives are given in brackets to two significant figures [I9]

Discharged parent	Progeny	Exposure pathway			
		Riverbank occupancy	Freshwater fish	Drinking water	Irrigated food
<sup>90</sup> Sr (29 a)	<sup>90</sup> Y (64 h)	Secular equilibrium assumed <sup>a</sup>	Dose coefficient for ingestion of parent accounts for progeny		
<sup>106</sup> Ru (370 d)	<sup>106</sup> Rh (30 s)	Secular equilibrium assumed <sup>a</sup>			
<sup>137</sup> Cs (30 a)	<sup>137m</sup> Ba (2.6 min)	<sup>137m</sup> Ba activity concentration in filtered water calculated at yield of 94.6% <sup>a</sup>			
<sup>210</sup> Pb (22 a)	<sup>210</sup> Bi (5.0 d) <sup>210</sup> Po (140 d)	Negligible doses from ingrowth compared with total dose for <sup>210</sup> Pb; not considered	Ingrowth limited during transit time in freshwater body; doses from progeny not included		
<sup>226</sup> Ra (1 600 a)	<sup>222</sup> Rn (3.8 d) <sup>218</sup> Po (3.1 min) <sup>214</sup> Pb (27 min) <sup>214</sup> Bi (20 min) <sup>214</sup> Po (164 µs) <sup>210</sup> Pb (22 a) <sup>210</sup> Bi (5.0 d) <sup>210</sup> Po (140 d)	<sup>222</sup> Rn gas mainly emitted to atmosphere; contributions from subsequent progeny omitted			
<sup>232</sup> Th (1.4 × 10 <sup>10</sup> a)	<sup>228</sup> Ra (5.8 a) <sup>228</sup> Ac (6.1 h) <sup>228</sup> Th (1.9 a) <sup>212</sup> Pb (11 h)	Secular equilibrium assumed <sup>a</sup>	Secular equilibrium assumed in water <sup>a</sup>	Secular equilibrium assumed in untreated water <sup>a</sup>	Deposition rate of parent used as proxy for secular equilibrium in soil after 100 years. Only <sup>228</sup> Ra, <sup>228</sup> Th and <sup>212</sup> Pb included
<sup>234</sup> U (2.4 × 10 <sup>5</sup> a)	<sup>230</sup> Th (7.7 × 10 <sup>4</sup> a)	Parent half-life sufficiently long that ingrowth not relevant at 100 years			
<sup>238</sup> U (4.5 × 10 <sup>9</sup> a)	<sup>234</sup> Th (24 d) <sup>234m</sup> Pa (1.2 min)	Secular equilibrium assumed <sup>a</sup>	Secular equilibrium assumed in water <sup>a</sup>	Secular equilibrium assumed in untreated water <sup>a</sup>	Deposition rate of parent used as proxy for secular equilibrium in soil after 100 years. Only <sup>234</sup> Th included
<sup>239</sup> Pu (2.4 × 10 <sup>4</sup> a)	<sup>235</sup> U (7.0 × 10 <sup>8</sup> a)	Parent half-life sufficiently long that ingrowth not relevant at 100 years			
<sup>240</sup> Pu (6 500 a)	<sup>236</sup> U (2.3 × 10 <sup>7</sup> a)				
<sup>241</sup> Am (430 a)	<sup>237</sup> Np (2.1 × 10 <sup>6</sup> a)				

<sup>a</sup> Dose rates calculated from parent and each progeny separately.

Table A7. Treatment of progeny for marine pathways

Half-lives are given in brackets to two significant figures [I9]

Discharged parent	Progeny	Exposure pathway	
		Beach occupancy	Marine food
<sup>90</sup> Sr (29 a)	<sup>90</sup> Y (64 h)	Secular equilibrium assumed <sup>a</sup>	Dose coefficient for ingestion of parent accounts for progeny
<sup>106</sup> Ru (370 d)	<sup>106</sup> Rh (30 s)		
<sup>137</sup> Cs (30 a)	<sup>137m</sup> Ba (2.6 min)		
<sup>210</sup> Pb (22 a)	<sup>210</sup> Bi (5.0 d) <sup>210</sup> Po (140 d)	Secular equilibrium assumed <sup>a</sup>	Secular equilibrium assumed in water; bioaccumulation factors for parent and progeny explicitly applied
<sup>226</sup> Ra (1 600 a)	<sup>222</sup> Rn (3.8 d) <sup>218</sup> Po (3.1 min) <sup>214</sup> Pb (27 min) <sup>214</sup> Bi (20 m) <sup>214</sup> Po (164 µs) <sup>210</sup> Pb (22 a) <sup>210</sup> Bi (5.0 d) <sup>210</sup> Po (140 d)	Most radon is assumed not emitted to atmosphere; secular equilibrium assumed <sup>a</sup>	Secular equilibrium assumed in water; bioaccumulation factors for parent and progeny explicitly applied
<sup>232</sup> Th (1.4 × 10 <sup>10</sup> a)	<sup>228</sup> Ra (5.8 a) <sup>228</sup> Ac (6.1 h) <sup>228</sup> Th (1.9 a) <sup>212</sup> Pb (11 h)	Secular equilibrium assumed <sup>a</sup>	Secular equilibrium assumed in water; bioaccumulation factors for parent and progeny explicitly applied
<sup>234</sup> U (2.4 × 10 <sup>5</sup> a)	<sup>230</sup> Th (7.7 × 10 <sup>4</sup> a)	Parent half-life sufficiently long that ingrowth not relevant at 100 years	
<sup>238</sup> U (4.5 × 10 <sup>9</sup> a)	<sup>234</sup> Th (24 d) <sup>234m</sup> Pa (1.2 min)	Secular equilibrium assumed <sup>a</sup>	Secular equilibrium assumed in water; bioaccumulation factors for parent and progeny explicitly applied
<sup>239</sup> Pu (2.4 × 10 <sup>4</sup> a)	<sup>235</sup> U (7.0 × 10 <sup>8</sup> a)	Parent half-life sufficiently long that ingrowth not relevant at 100 years	
<sup>240</sup> Pu (6 500 a)	<sup>236</sup> U (2.3 × 10 <sup>7</sup> a)		
<sup>241</sup> Am (430 a)	<sup>237</sup> Np (2.1 × 10 <sup>6</sup> a)		

<sup>a</sup> Dose rates from external exposure calculated from parent and each progeny separately.



## REFERENCES

- A1 Andersson, K.G. On the current needs in European decision support tools for contaminated areas. *Radioprotection* 48(5): S57-S64 (2013).
- A2 Apostoaei, A.I., S.K. Nair, B.A. Thomas et al. External exposure to radionuclides accumulated in shoreline sediments with an application to the lower Clinch River. *Health Phys* 78(6): 700-710 (2000).
- B1 Beck, H.L. Exposure rate conversion factors for radionuclides deposited on the ground. EML-378. Environmental Measurements Laboratory, Department of Energy, New York, 1980.
- B2 Bergman, R., U. Bergström and S. Evans. Environmental transport and long-term exposure for tritium released in the biosphere. pp.535-554 in: *Proceedings of the International Symposium on the Behaviour of Tritium in the Environment*. International Atomic Energy Agency, Vienna, 1979.
- B3 Bertrand, M. Consommations et lieux d'achats des produits alimentaires en 1991. INSEE résultats. *Consommation-Mode de vie* n°54-55. Institut national de la statistique et des études économiques (INSEE), Paris, 1993. (French).
- B4 Booth, R.S. A systems analysis model for calculation of radionuclide transport between receiving waters and bottom sediments. pp.133-164 in: *Environmental Toxicity of Aquatic Radionuclides: Models and Mechanisms* (M.W. Miller and J.S. Stannard, eds.). Ann Arbor Science Publishers Inc, 1976.
- B5 Brewer, B. Irrigation expenses threaten vineyards. *Contra Costa Times*, 21 January, 2001.
- B6 Brown, J. and J.R. Simmonds. FARMLAND a dynamic model for the transfer of radionuclides through terrestrial foodchains. NRPB-R273. National Radiological Protection Board, Chilton, Didcot, 1995.
- B7 Brown, J., D. Hammond and B.T. Wilkins. Handbook for assessing the impact of a radiological incident on levels of radioactivity in drinking water and risks to operatives at water treatment works. HPA-RPD-040. Health Protection Agency, Oxford, 2008.
- B8 Burson, Z.G. and A.E. Profio. Structure shielding in reactor accidents. *Health Phys* 33(4): 287-299 (1977).
- C1 Calmon, P., Y. Thiry, G. Zibold et al. Radionuclide transfer in forest ecosystems. pp.333-380 in: *Quantification of Radionuclide Transfer in Terrestrial and Freshwater Environments for Radiological Assessments*. IAEA-TECDOC-1616. International Atomic Energy Agency, Vienna, 2009.
- C2 CEC. Methodology for evaluating the radiological consequences of radioactive effluents released in normal operations. National Radiological Protection Board and Commissariat à l'Énergie Atomique. Document no. V/3865/79. Commission of the European Communities, Luxembourg, 1979.
- C3 CEC. Commission Recommendation of 18 December 2003 on standardised information on radioactive airborne and liquid discharges into the environment from nuclear power reactors and reprocessing plants in normal operation (2004/2/Euratom). *Official Journal of the European Union* L2. Commission of the European Communities, Luxembourg, 2004.

- C4 Ciffroy, P., F. Siclet, C. Damois et al. A dynamic model for assessing radiological consequences of routine releases in the Loire river: parameterisation and uncertainty/sensitivity analysis. *J Environ Radioact* 83(1): 9-48 (2005).
- C5 Crawford, T.V., C.W. Miller and A.H. Weber. Atmospheric transport of radionuclides. pp.79-140 in: *Radiological Risk Assessment and Environmental Analysis* (J.E. Till and H.A. Grogan, eds.). Oxford University Press, Inc., New York, 2008.
- C6 CSA. Guidelines for calculating derived release limits for radioactive material in airborne and liquid effluents for normal operation of nuclear facilities. CSA N288.1. Canadian Standards Association, Canada, 2014.
- E1 Eaton, D. and C.E. Murphy Jr. Tritium uptake by fish in a small stream. WSRC-TR--92-193 Rev.1. Westinghouse Savannah River Co., Aiken, SC, 1992.
- E2 Eckerman, K.F. and J.C. Ryman. External exposure to radionuclides in air, water, and soil. EPA-402-R-93-081. Federal Guidance Report No. 12. U.S. Environmental Protection Agency, Washington, D.C., 1993.
- E3 Encyclopaedia Britannica. Paraná River, South America. [Internet] Available from (<https://www.britannica.com/place/Parana-River>) on 06.12.2016.
- F1 FAO. FAO statistical yearbook 2010. Food and Agriculture Organization of the United Nations. [Internet] Available from (<http://www.fao.org/economic/ess/ess-publications/ess-yearbook/ess-yearbook2010/en/>) on 10.10.2015.
- F2 FAO. FishStatJ - software for fishery statistical time series. Food and Agriculture Organization of the United Nations. [Internet] Available from (<http://www.fao.org/fishery/statistics/software/fishstatj/en>) on 08.05.2012.
- F3 FAO. FAO/Stat. Food and Agriculture Organization of the United Nations. [Internet] Available from (<http://faostat3.fao.org/download/FB/BL/E>) on 06.10. 2014.
- F4 FAO. AQUASTAT - FAO's information system on water and agriculture. Food and Agriculture Organization of the United Nations. [Internet] Available from (<http://www.fao.org/nr/water/aquastat/main/index.stm>) on 09.07.2014.
- G1 Geyh, A.S., J. Xue, H. Ozkaynak et al. The Harvard Southern California Chronic Ozone Exposure Study: assessing ozone exposure of grade-school-age children in two Southern California communities. *Environ Health Perspect* 108(3): 265-270 (2000).
- G2 Golikov, V.Y., M.I. Balonov and P. Jacob. External exposure of the population living in areas of Russia contaminated due to the Chernobyl accident. *Radiat Environ Biophys* 41(3): 185-193 (2002).
- H1 Hamza, W. The Nile fishes and fisheries, Chapter 14. pp.349-370 in: *Biodiversity - the Dynamic Balance of the Planet* (O. Grillo, ed.) InTech, 2014.
- H2 Heimann, D.C., L.A. Sprague and D.W. Blevins. Trends in suspended-sediment loads and concentrations in the Mississippi river basin, 1950–2009. Scientific Investigations Report 2011–5200. National Water-Quality Assessment Program, U.S. Geological Survey, Virginia, U.S.A., 2011.
- H3 Hejduk, A. and K. Banasik. Suspended sediment concentration and yield in snowmelt flood events in a small lowland river. *Ann Warsaw Univ of Life Sci – SGGW, Land Reclam* 42(1): 61-68 (2010).



- H4 Hilton, J., S. Small, D. Hornby et al. Modelling the combined impact of radionuclide discharges reaching rivers. EA-RD-TR--P3-068/TR. [https://inis.iaea.org/search/search.aspx?orig\\_q=RN:34037229](https://inis.iaea.org/search/search.aspx?orig_q=RN:34037229), 2003.
- I1 IAEA. Handbook of parameter values for the prediction of radionuclide transfer in temperate environments. Technical Reports Series No. 364. International Atomic Energy Agency, Vienna, 1994.
- I2 IAEA. Generic models for use in assessing the impact of discharges of radioactive substances to the environment. Safety Reports Series No.19. International Atomic Energy Agency, Vienna, 2001.
- I3 IAEA. Sediment distribution coefficients and concentration factors for biota in the marine environment. Technical Reports Series No. 422. International Atomic Energy Agency, Vienna, 2004.
- I4 IAEA. Quantification of radionuclide transfer in terrestrial and freshwater environments for radiological assessments. IAEA-TECDOC-1616. International Atomic Energy Agency, Vienna, 2009.
- I5 IAEA. Handbook of parameter values for the prediction of radionuclide transfer in terrestrial and freshwater environments. Technical Reports Series No. 472. International Atomic Energy Agency, Vienna, 2010.
- I6 IAEA. Performance of models in radiological impact assessment for normal operation. IAEA-TECDOC-1808. International Atomic Energy Agency, Vienna, 2017.
- I7 ICID. International Commission on Irrigation and Drainage. [Internet] Available from ([http://www.icid.org/sprin\\_micro\\_11.pdf](http://www.icid.org/sprin_micro_11.pdf).) on 06.11.2014.
- I8 ICRP. Limits for intakes of radionuclides by workers. ICRP Publication 30 (Part 1). Annals of the ICRP 2(3-4). International Commission on Radiological Protection, Pergamon Press, Oxford, 1979.
- I9 ICRP. Radionuclide transformations - energy and intensity of emissions. ICRP Publication 38. Annals of the ICRP 11-13. International Commission on Radiological Protection, Pergamon Press, Oxford, 1983.
- I10 ICRP. 1990 Recommendations of the International Commission on Radiological Protection. ICRP Publication 60. Annals of the ICRP 21(1-3). International Commission on Radiological Protection, Pergamon Press, Oxford, 1991.
- I11 ICRP. Human respiratory tract model for radiological protection. ICRP Publication 66. Annals of the ICRP 24(1-3). International Commission on Radiological Protection, Pergamon Press, Oxford, 1994.
- I12 ICRP. Age-dependent doses to members of the public from intake of radionuclides: Part 5. Compilation of ingestion and inhalation dose coefficients. ICRP Publication 72. Annals of the ICRP 26(1). International Commission on Radiological Protection, Pergamon Press, Oxford, 1995.
- I13 ICRP. The 2007 Recommendations of the International Commission on Radiological Protection. ICRP Publication 103. Annals of the ICRP 37(2-4). International Commission on Radiological Protection, Elsevier Ltd., 2007.

- I14 ICRP. Compendium of dose coefficients based on ICRP Publication 60. ICRP Publication 119. *Annals of the ICRP* 41(Suppl. 1). International Commission on Radiological Protection, Elsevier Ltd., Oxford, 2012.
- I15 ICRU. Gamma-ray spectrometry in the environment. ICRU Report 53. International Commission on Radiation Units and Measurements, Bethesda, MA, 1994.
- J1 Jacob, P., H. Rosenbaum, N. Petoussi et al. Calculation of organ doses from environmental gamma rays using human phantoms and Monte Carlo methods. Part II: Radionuclides distributed in the air or deposited on the ground. GSF Report 12/90. National Research Centre for Environment and Health, Neuherberg, Germany, 1990.
- J2 Jacob, P. and R. Meckbach. External exposure from deposited radionuclides. pp.407-422 in: *Proceedings of the Seminar on Methods and Codes for Assessing the Off-site Consequences of Nuclear Accidents. Volume I.* EUR 13013/1 EN. Commission of the European Communities, Luxembourg, 1991.
- J3 Jacob, P., G. Pröhl, I. Likhtarev et al. Pathway analysis and dose distributions. EUR 16541 EN. European Commission, Brussels, 1996.
- J4 Jeon, W.-T., S.-O. Hur, K.-Y. Seong et al. Effect of green manure hairy vetch on rice growth and saving of irrigation water. *Korean J Soil Sci Fert* 44(2): 181-186 (2011).
- J5 Jones, K.A., C. Walsh, A. Bexon et al. Guidance on the assessment of radiation doses to members of the public due to the operation of nuclear installations under normal conditions. HPA-RPD-019. Health Protection Agency, Chilton, 2006.
- J6 Jones, K.A., J.G. Smith, T. Anderson et al. Implied doses to the population of the EU arising from reported discharges from EU nuclear power stations and reprocessing sites in the years 2004 to 2008. Radiation Protection No. 176. European Commission, Luxembourg, 2013.
- K1 Kane, P. ECOS: sorption, dose, consumption and miscellaneous data values. Associated Nuclear Services, Epsom UK, 1984.
- K2 Kelly, G.N., J.A. Jones and P.M. Bryant. The predicted radiation exposure of the population of the European Community resulting from discharges of krypton-85, tritium, carbon-14 and iodine-129 from the nuclear power industry to the year 2000. Document V/2676/75. Commission of the European Communities, Luxembourg, 1975.
- K3 Killough, G.G. and P.S. Rohwer. A new look at the dosimetry of <sup>14</sup>C released to the atmosphere as carbon dioxide. *Health Phys* 34(2): 141-159 (1978).
- K4 Killough, G.G. and D.C. Kocher. Global environmental transport models for tritium. CONF-850405-7. Oak Ridge National Laboratory, 1985.
- K5 Kim, S.B., W.J.G. Workman, P.A. Davis et al. Tritium concentrations in the Perch Lake ecosystem. AECL document CTD-03700-ENA-003. Chalk River Laboratories, Ontario, 2004.
- K6 Kocher, D.C. Effects of indoor residence on radiation doses from routine releases of radionuclides to the atmosphere. *Nucl Technol* 48(2): 171-179 (1980).
- L1 Le Grand, J., Y. Roux, R. Meckbach et al. External exposure from airborne radionuclides. pp.385-406 in: *Proceedings of the Seminar on Methods and Codes for Assessing the Off-site Consequences of Nuclear Accidents. Volume I.* EUR 13013/1 EN. Commission of the European Communities, Luxembourg, 1991.

- L2 Likhtarev, I.A., L.N. Kovgan, P. Jacob et al. Chernobyl accident: retrospective and prospective estimates of external dose of the population of Ukraine. *Health Phys* 82(3): 290-303 (2002).
- M1 Maringer, F.J. Four decades of radioecological research on the Danube river: a reliable basis for protecting the freshwater resources of central Europe of tomorrow. pp.P-4b-259 in: IRPA-10. Proceedings of the 10th International Congress of the International Radiation Protection Association on Harmonization of Radiation, Human Life and the Ecosystem. Japan Health Physics Society, Japan, 2000.
- M2 Milliman, J.D. and K.L. Farnsworth. *River Discharge to the Coastal Ocean: a Global Synthesis*. Cambridge University Press, 2011.
- N1 NCRP. Tritium in the environment. NCRP Report No. 62. National Council on Radiation Protection and Measurements, Bethesda, 1979.
- N2 NCRP. Screening models for releases of radionuclides to atmosphere, surface water, and ground. NCRP Report No. 123. National Council on Radiation Protection and Measurements, Bethesda, 1996.
- N3 NCRP. Ionizing radiation exposure of the population of the United States. NCRP Report No. 160. National Council on Radiation Protection and Measurements, Bethesda, 2009.
- N4 NEA. Radiological impacts of spent nuclear fuel management options: a comparative study. Nuclear Energy Agency, NEA/OECD, Paris, 2000.
- N5 Nikitin, A.I., V.B. Chumichev, N.K. Valetova et al. The current content of artificial radionuclides in the water of the Tobol-Irtysh river system (from the mouth of the Iset River to the confluence with the Ob River). *J Environ Radioact* 96(1-3): 138-143 (2007).
- N6 NRC. Final environmental statement on the transportation of radioactive materials by air and other modes. NUREG-0170. Volume 1. Nuclear Regulatory Commission, United States, 1977.
- O1 Onishi, Y. Suspended sediment concentrations for large and small rivers. Official communication to the UNSCEAR secretariat. 2013.
- O2 Ott, W.R. Human activity patterns: a review of the literature for estimating time spent indoors, outdoors, and in transit. Proceedings of the Research Planning Conference on Human Activity Patterns. EPA/600/4-89/004. EPA National Exposure Research Laboratory, Las Vegas, 1989.
- P1 Pawar, D.H. and M.S. Palaskar. Irrigation scheduling based on soil-crop-climate integrated approach: A case study of Upper Pengana Project in Maharashtra. Proceedings of the 4th International R&D Conference on Water and Energy for 21st Century, Aurangabad, Maharashtra, India, Volume 1. 2003.
- P2 Petoussi-Hens, N., H. Schlattl, M. Zankl et al. Organ doses from environmental exposures calculated using voxel phantoms of adults and children. *Phys Med Biol* 57(18): 5679-5713 (2012).
- R1 Rommens, C., D. Laurier and A. Sugier. Methodology and results of the Nord-Cotentin radioecological study. *J Radiol Prot* 20(4): 361-380 (2000).
- S1 Schauer, D.A. and O.W. Linton. NCRP Report No. 160, Ionizing Radiation Exposure of the Population of the United States, medical exposure--are we doing less with more, and is there a role for health physicists? *Health Phys* 97(1): 1-5 (2009).
- S2 Schimmack, W., H. Steindl and K. Bunzl. Variability of water content and of depth profiles of global fallout <sup>137</sup>Cs in grassland soils and the resulting external gamma-dose rates. *Radiat Environ Biophys* 37(1): 27-33 (1998).

- S3 Shahul Hameed, P., K. Shaheed and S.S.N. Somasundaram. A study on distribution of natural radionuclide polonium-210 in a pond ecosystem. *J. Biosciences* 22(5): 627-634 (1997).
- S4 Sheppard, S.C., P. Ciffroy, F. Siclet et al. Conceptual approaches for the development of dynamic specific activity models of <sup>14</sup>C transfer from surface water to humans. *J Environ Radioact* 87(1): 32-51 (2006).
- S5 Sheppard, S.C., M.I. Sheppard and F. Siclet. Parameterization of a dynamic specific activity model of <sup>14</sup>C transfer from surface water-to-humans. *J Environ Radioact* 87(1): 15-31 (2006).
- S6 Simmonds, J.R., G. Lawson and A. Mayall. Methodology for assessing the radiological consequences of routine releases of radionuclides to the environment. EUR 15760. European Commission, Luxembourg, 1995.
- S7 Simmonds, J.R., A.P. Bexon, S. Lepicard et al. Annex D: Radiological impact on EU member states of radioactivity in north european waters. In: MARINA II. Update of the MARINA Project on the Radiological Exposure of the European Community from Radioactivity in North European Marine Waters. Radiation Protection 132. European Commission, Luxembourg, 2002.
- S8 Smith, J.G. and J.R. Simmonds. The methodology for assessing the radiological consequences of routine releases of radionuclides to the environment used in PC-CREAM 08. HPA-RPD-058. Health Protection Agency, Chilton, Didcot, 2009.
- S9 Smith, K.R., A.P. Bexon, K. Sihra et al. Guidance on the calculation, presentation and use of collective doses for routine discharges. Radiation Protection 144. European Commission, Luxembourg, 2007.
- S10 Sprague, L.A., M.L. Clark, D.L. Rus et al. Nutrient and suspended-sediment in the Missouri river basin, 1993-2003. Scientific Investigation Report 2006-5231. National Water-Quality Assessment Program. U.S. Geological Survey, Virginia, 2007.
- S11 Sudan. Data for 2012 (internal report). Statistical Bulletin for Animal Resources, Issue no. 21-22. Ministry of Animal Resources and Fisheries, Sudan, 2011.
- T1 Titley, J.G., T. Cabianca and G. Lawson. Improved global dispersion models for iodine-129 and carbon-14. EUR 15880 EN. European Commission, Luxembourg, 1995.
- U1 UN. Population division, population estimates and projections section. United Nations. [Internet] Available from ([http://esa.un.org/unpd/ppp/Figures-Output/Population/PPP\\_Total-Population.htm](http://esa.un.org/unpd/ppp/Figures-Output/Population/PPP_Total-Population.htm)) on 01.12.2014.
- U2 UN. Demographic yearbook. United Nations. [Internet] Available from (<http://unstats.un.org/unsd/demographic/products/dyb/dyb2.htm>) on 01.12.2014.
- U3 UNEP. GEO-3 regions. United Nations Environment Programme. [Internet] Available from (<http://geodata.grid.unep.ch/images/regions.jpg>) on 16.02.2015.
- U4 UNSCEAR. Ionizing Radiation: Sources and Biological Effects. UNSCEAR 1982 Report. United Nations Scientific Committee on the Effects of Atomic Radiation, 1982 Report to the General Assembly, with annexes. United Nations sales publication E.82.IX.8. United Nations, New York, 1982.
- U5 UNSCEAR. Sources, Effects and Risks of Ionizing Radiation. UNSCEAR 1988 Report. United Nations Scientific Committee on the Effects of Atomic Radiation, 1988 Report to the General Assembly, with annexes. United Nations sales publication E.88.IX.7. United Nations, New York, 1988.

- U6 UNSCEAR. Sources and Effects of Ionizing Radiation. Volume I: Sources. UNSCEAR 2000 Report. United Nations Scientific Committee on the Effects of Atomic Radiation, 2000 Report to the General Assembly, with scientific annexes. United Nations sales publication E.00.IX.3. United Nations, New York, 2000.
- U7 UNSCEAR. Sources and Effects of Ionizing Radiation. Volume II: Effects. UNSCEAR 2000 Report. United Nations Scientific Committee on the Effects of Atomic Radiation, 2000 Report to the General Assembly, with scientific annexes. United Nations sales publication E.00.IX.4. United Nations, New York, 2000.
- U8 UNSCEAR. Effects of Ionizing Radiation. Volume I: Report to the General Assembly, Scientific Annexes A and B. UNSCEAR 2006 Report. United Nations Scientific Committee on the Effects of Atomic Radiation. United Nations sales publication E.08.IX.6. United Nations, New York, 2008.
- U9 UNSCEAR. Effects of Ionizing Radiation. Volume II: Scientific Annexes C, D and E. UNSCEAR 2006 Report. United Nations Scientific Committee on the Effects of Atomic Radiation. United Nations sales publication E.09.IX.5. United Nations, New York, 2009.
- U10 UNSCEAR. Sources and Effects of Ionizing Radiation. Volume I: Sources: Report to the General Assembly, Scientific Annexes A and B. UNSCEAR 2008 Report. United Nations Scientific Committee on the Effects of Atomic Radiation. United Nations sales publication E.10.XI.3. United Nations, New York, 2010.
- U11 UNSCEAR. Sources and Effects of Ionizing Radiation. Volume II: Effects. Scientific Annexes C, D and E. UNSCEAR 2008 Report. United Nations Scientific Committee on the Effects of Atomic Radiation. United Nations sales publication E.11.IX.3. United Nations, New York, 2011.
- U12 UNSCEAR. Sources, Effects and Risks of Ionizing Radiation. Volume I: Report to the General Assembly and Scientific Annex A. UNSCEAR 2013 Report. United Nations Scientific Committee on the Effects of Atomic Radiation. United Nations sales publication E.14.IX.1. United Nations, New York, 2014.
- U13 UNSCEAR. Sources, Effects and Risks of Ionizing Radiation. Report to the General Assembly and Scientific Annexes A and B. UNSCEAR 2012 Report. United Nations Scientific Committee on the Effects of Atomic Radiation. United Nations sales publication E.16.IX.1. United Nations, New York, 2015.
- U14 USDA. 1984 farm and ranch irrigation survey. AG84-SR-1 Special Report Series. United States Department of Agriculture, USDA Bureau of Census, U.S. Department of Commerce, 1986.
- V1 Vanoni, V.A. Sedimentation Engineering. Hydraulic Division, The American Society of Civil Engineers, New York, 1975.
- W1 Wahaab, R.A. and M.I. Badawy. Water quality assessment of the River Nile system: an overview. *Biomed Environ Sci* 17(1): 87-100 (2004).
- W2 WHO. Global Environment Monitoring System (GEMS/Food) - Food contamination monitoring and assessment programme. World Health Organization. [Internet] Available from (<https://extranet.who.int/gemsfood/>) on 14.09.2015.
- W3 WHO. Guidelines for drinking-water quality. Fourth Edition. World Health Organization, Geneva, 2011.
- Z1 Zankl, M., N. Petoussi and G. Drexler. Effective dose and effective dose equivalent--the impact of the new ICRP definition for external photon irradiation. *Health Phys* 62(5): 395-399 (1992).



## ANNEX B

# RADIATION EXPOSURES FROM ELECTRICITY GENERATION





## CONTENTS

I. INTRODUCTION .....	139
A. Scope.....	140
II. BACKGROUND .....	141
A. Global trends in electricity generation technology .....	142
B. Electricity generation worldwide in 2010.....	144
III. ASSESSMENT APPROACH AND END POINTS.....	145
A. Recapitulation of key features of the methodology for estimating public exposures due to radioactive discharges.....	147
IV. RADIATION EXPOSURES ARISING FROM ELECTRICITY GENERATION BY NUCLEAR POWER .....	151
A. Introduction.....	151
B. Public exposure.....	152
C. Occupational exposure for the nuclear fuel cycle .....	174
D. Decommissioning.....	178
V. RADIATION EXPOSURES ARISING FROM ELECTRICITY GENERATION BY COMBUSTION OF FOSSIL FUELS .....	182
A. Coal.....	182
B. Natural gas .....	194
C. Oil .....	197
D. Comparisons of exposures from fossil-fuel electricity generation .....	199
VI. RADIATION EXPOSURES ARISING FROM ELECTRICITY GENERATION FROM GEOHERMAL ENERGY.....	199
VII. ASSESSING DOSES FROM THE CONSTRUCTION PHASE OF ELECTRICITY-GENERATING TECHNOLOGIES .....	201
VIII.COMPARISON OF RADIATION EXPOSURES FROM ELECTRICITY-GENERATING TECHNOLOGIES .....	211
A. Comparison of public exposures due to radioactive discharges from the electricity-generating technologies based on the nuclear fuel cycle, coal cycle, combustion of natural gas and oil, and use of geothermal energy .....	211
B. Comparison of public and occupational exposures .....	220
C. Commentary on significance of accidents .....	224

IX. RESEARCH NEEDS.....	225
X. CONCLUSIONS.....	227
XI. ACKNOWLEDGEMENTS .....	229
REFERENCES.....	231

## I. INTRODUCTION

1. A reliable and affordable supply of electricity is important to improve human health and welfare worldwide, an objective recognized by both the United Nations Millennium Development Goals [U2, U3] and Sustainable Development Goals.<sup>1</sup> However, policy makers and the general public also have interest in the impacts of electricity generation on humankind and the environment.

2. Interest in exposure of the public and workers to radiation due to nuclear power dates back to the earliest use of the technology. The first UNSCEAR Report to the General Assembly in 1958 included data on exposures of contract employees of the United States Atomic Energy Commission and a recognition of the need to keep track of the exposure of workers in view of the anticipated growth in the use of nuclear technology and the associated worker population [U4]. Since then, the Committee has periodically reviewed exposures of both the public and of workers, related to nuclear power [U5, U6, U7, U8, U9, U11]. As a result, the Committee's records of exposures of workers and the public from nuclear power provide one of the most complete and accurate global pictures of radiation exposures from any source of ionizing radiation.

3. The Committee has conducted evaluations of radiation exposures of the public arising from forms of electricity generation other than nuclear power to a much more limited extent. Radiation exposures from industrial activities outside of the nuclear sector are generally not monitored or reported in a systematic manner; consequently, the assessment of these exposures has often relied on incomplete data from isolated surveys or ad hoc collection of data from various reports and publications.

4. The Committee's thematic priorities identified in its strategic plan<sup>2</sup> for 2009–2013 included radiation levels of energy production and in its plan<sup>3</sup> for 2014–2019 the global impact of energy production. The Committee decided to update its assessments of the exposures from electricity generation, considering the principal relevant commercial technologies, both nuclear and non-nuclear.

5. The world's mix of electricity-generating technologies changes over time in response to the landscape of climatic, environmental, resource, political and economic challenges. Governments and researchers may conduct various comparative studies that among other things take into account the various implications for the public and the environment of the different technologies. Exposure to ionizing radiation is only one of the many factors that such assessments may take into account. However, the Committee considers that an update and extension of its past assessments of radiation exposures of the public and workers from electricity generation could be a useful source of information for such studies.

6. This scientific annex thus presents an analysis of the total population exposure, public and occupational, to ionizing radiation from the different life cycle stages of electricity-generating technologies, normalized to the electricity generated during one year for that technology. The annex is also an update and extension of the Committee's earlier evaluations of radiation exposures resulting from discharges associated with different electricity-generating technologies. The Committee

---

<sup>1</sup> *Transforming our world: the 2030 Agenda for Sustainable Development. Resolution adopted by the General Assembly on 25 September 2015. General Assembly, Seventieth session, Agenda items 15 and 116 (A/RES/70/1).*

<sup>2</sup> *Official Records of the General Assembly, Sixty-third session, Supplement No. 46 (A/63/46).*

<sup>3</sup> *Official Records of the General Assembly, Sixty-eighth session, Supplement No. 46 (A/68/46).*

emphasizes that the objective of this study was comparative in nature. Common approaches, available data and balanced assumptions for assessing the main exposures and identifying the dominant components of those exposures for different electricity-generating technologies have been used to the extent possible.

7. Specifically, the following core questions have been addressed:

- How do the individual and population exposures of humans to ionizing radiation that result from different phases of the life cycle of each electricity-generating technology compare with each other across the world and by region?
- What are the main factors, in terms of principal sources, radionuclides, time periods and exposed populations, contributing to the exposure for each technology?
- What would be needed to improve such assessments in the future in terms of data and research?

8. To conduct the assessment, the Committee has in parallel reviewed and revised its methodology for estimating exposures of the public due to radioactive discharges (annex A). Other exposures, such as occupational exposures, are assessed using other methods described here.

## A. Scope

9. This annex describes an assessment of the exposures to ionizing radiation in the life cycle of electricity-generating technologies that are currently deployed commercially, and fuelled by nuclear energy, combustion of coal, oil or gas, geothermal energy, solar energy, wind or biomass. The assessment includes exposures from activities in the life cycle of each technology that are relevant to the radiological impact, from construction to decommissioning. For electricity-generating technologies using solar energy, wind and biomass, the only activity that has been assessed in this context is the mining of metals needed for construction. Exposures from electrical energy storage, transmission and distribution are not considered. Moreover, the evaluation does not address energy generation other than electricity generation, such as process heat generation or other means of distributing energy, such as district heating.

10. The assessment considers normal operations only. Exposures from incidents and accidents are not considered in detail here; the Committee has earlier reviewed radiation exposures in accidents (annex C [U12]), and considered in detail the radiation exposures from the 1986 accident at the Chernobyl nuclear power plant (annex D [U12]) and the 2011 accident at the Fukushima-Daiichi nuclear power station (annex A [U13]) and continues to monitor developments after these accidents. The annex discusses their significance only in drawing conclusions from this assessment for the General Assembly.

11. The assessment is limited to considering individual and population exposure of humans. Exposures of non-human biota in the environment are not considered. Assessing impacts other than radiation exposure from electricity generation, such as social benefits, economic issues, or non-proliferation or security matters, is outside of the Committee's remit and competence.

12. This work aims to compare exposures to ionizing radiation for different electricity-generating technologies where individual and collective doses may be used for performing a comparative exposure assessment. However, calculated doses are recommended only for comparative purposes and not for

estimations related to health effects. It is important to state that collective doses, as used here, are solely an instrument to compare radiation exposures for different technologies used for electricity generation. Collective dose is not intended as a tool for epidemiological risk assessment. Moreover, the aggregation of very low individual doses over extended time periods is inappropriate for use in risk projections and, in particular, the calculation of numbers of cancer deaths from collective doses based on individual doses that are well within the variation in background exposure should be avoided. Collective doses estimated in this annex only provide information for decision makers and researchers on radiation exposures from different electricity generation technologies. Dose estimations for the evaluation of implications for health should be more specific to each exposure situation.

13. The annex begins with a chapter providing background information to support the study, followed by a chapter discussing the assessment approach and the end points for the study. That chapter also includes a description of terminology relevant to applying the methodology for estimating public exposures due to radioactive discharges (see annex A). The following chapters cover the radiation exposures arising from electricity generation from each of the electricity-generating technologies: nuclear fuel cycle, fossil fuel energy (coal, oil and gas) and geothermal energy. Next comes a chapter on assessing occupational doses from the mining of metals for the construction phase of the electricity-generating technologies: nuclear, coal, natural gas and the renewable technologies (biomass, solar and wind). Finally, there are chapters that include comparisons of exposures from the principal electricity-generating technologies, discussions of uncertainties, suggestions for future work that could improve understanding, and concluding remarks. Note that all supporting values and calculations were manipulated with full precision and any discrepancies in the numbers presented in tables and figures are due to rounding.

## II. BACKGROUND

14. The Committee's past assessments in this field have covered each stage of the nuclear fuel cycle: resource extraction (uranium mining and milling); fuel manufacture (uranium enrichment and fuel fabrication); power generation (nuclear power reactors); reprocessing of spent nuclear fuel to recover uranium and plutonium for subsequent use in nuclear fuels; and the management of solid wastes generated at the various stages. They have also included exposures from transportation activities within and between the fuel-cycle stages [U5, U6, U7, U8, U9, U11].

15. The Committee's most recent and comprehensive review of public exposures due to non-nuclear electricity generation (coal, oil, natural gas, peat and geothermal technologies) was published in 1993 [U8], based principally on the parameters and assessments presented in the UNSCEAR 1988 Report [U7] and the assessment methodology adopted in the UNSCEAR 1982 Report [U6]. Public exposures were expressed in terms of the collective effective dose normalized to electricity generated, in units of man-sieverts per gigawatt-year. The results from those earlier UNSCEAR assessments of normalized collective effective doses to the public from discharges for various electricity-generating technologies are summarized in table 1.

16. According to the UNSCEAR 1993 Report, public exposures in terms of collective effective dose per year of practice and per unit of electricity generated due to the burning of coal and peat, and due to geothermal sources exceeded that due to operational discharges from nuclear power generation. However, with continued improvements in efficiency of electricity generation from fossil-fuel plants and in emission control technology, those earlier estimates of the Committee were deemed very likely to be outdated and potentially misleading. Reductions in exposures were expected from newer and retrofitted power plants.

Since its 1993 evaluation, the Committee had only updated its estimates of exposures from the generation of nuclear power, where the most recent estimates showed a decrease for the normalized collective effective dose to the public from power plant operation from 0.45 man Sv/(GW a) for the period 1990–1994 to 0.27 man Sv/(GW a) for the period 1998–2002 [U11].

**Table 1. Collective effective dose to the public normalized to electricity generated due to discharges from different electricity-generating technologies from previous UNSCEAR assessments**

UNSCEAR Report	Normalized collective effective dose to public (man Sv/(GW a))					
	Nuclear power plant operation	Coal	Peat	Gas	Oil	Geothermal
1982 [U6]	4.2 <sup>a</sup>	2	—	—	—	6
1988 [U7]	2.5 <sup>b</sup>	4 <sup>c</sup>	2	0.03	0.5	2
1993 [U8] <sup>d</sup>	1.34 <sup>e</sup>	20 <sup>f</sup>	—	(0.03)	(0.5)	(2)
2000 (for 1990–1994) [U9]	0.45 <sup>g</sup>	—	—	—	—	—
2008 (for 1998–2002) [U11]	0.27 <sup>h</sup>	—	—	—	—	—

<sup>a</sup> The value for the nuclear fuel cycle was 5.7 man Sv/(GW a); for globally-circulating radionuclides after 100 years the value was 12 man Sv/(GW a); for uranium mill tailings after 100 years, the value was 0.25 man Sv/(GW a).

<sup>b</sup> The value for the nuclear fuel cycle was 4.0 man Sv/(GW a); for mine and mill tailings and globally-circulating radionuclides the total was 200 man Sv/(GW a).

<sup>c</sup> The value was 6 man Sv/(GW a) for older coal-fired power plants, which were considered to constitute two thirds of the world total and 0.3 man Sv/(GW a) for modern coal-fired power plants, which were considered to constitute one third of the world total.

<sup>d</sup> The values reported in the UNSCEAR 1993 Report [U8] for gas, oil and geothermal technologies were not from new assessments but taken from the UNSCEAR 1988 Report [U7].

<sup>e</sup> The value for the nuclear fuel cycle was 3.0 man Sv/(GW a); for globally-circulating radionuclides after 100 years the value was 50 man Sv/(GW a); for uranium mine and mill tailings after 100 years, the value was 150 man Sv/(GW a).

<sup>f</sup> From coal-fired power plants (assumed one third modern-style, one third old-style and one third Chinese-style [U8]).

<sup>g</sup> The reported dose value is for power plant operation only.

<sup>h</sup> The value for the nuclear fuel cycle was 0.72 man Sv/(GW a).

## A. Global trends in electricity generation technology

17. Figure I shows the global trends in electricity generation and contributions made by the various electricity-generating technologies between 1980 and 2014. Combustion of coal for electricity generation has dominated during this period with nearly 40% of total electricity generated; at the same time, total global electricity generation has grown by about a factor of three. The use of both natural gas and nuclear fuels to generate electricity has grown as a percentage of the total and also in total amount of electricity generated over the same period. The use of oil has fallen as a percentage of the total, but only slightly in total electricity generated. The use of hydropower has increased in the total amount of electricity generation, although it has fallen as a percentage of the total. The contribution of the “others” category, which includes renewable energies (geothermal, wind, solar and biomass), has increased from 1% to 7% during the 34 years, with a faster increase in their use since about 2008.

Figure I. Trends in worldwide electricity generation (GW a) from 1980 to 2014

The "others" category comprises geothermal, solar, wind, biomass and waste [W13]. Supporting values were expressed as full precision and any discrepancies in the numbers presented are due to rounding

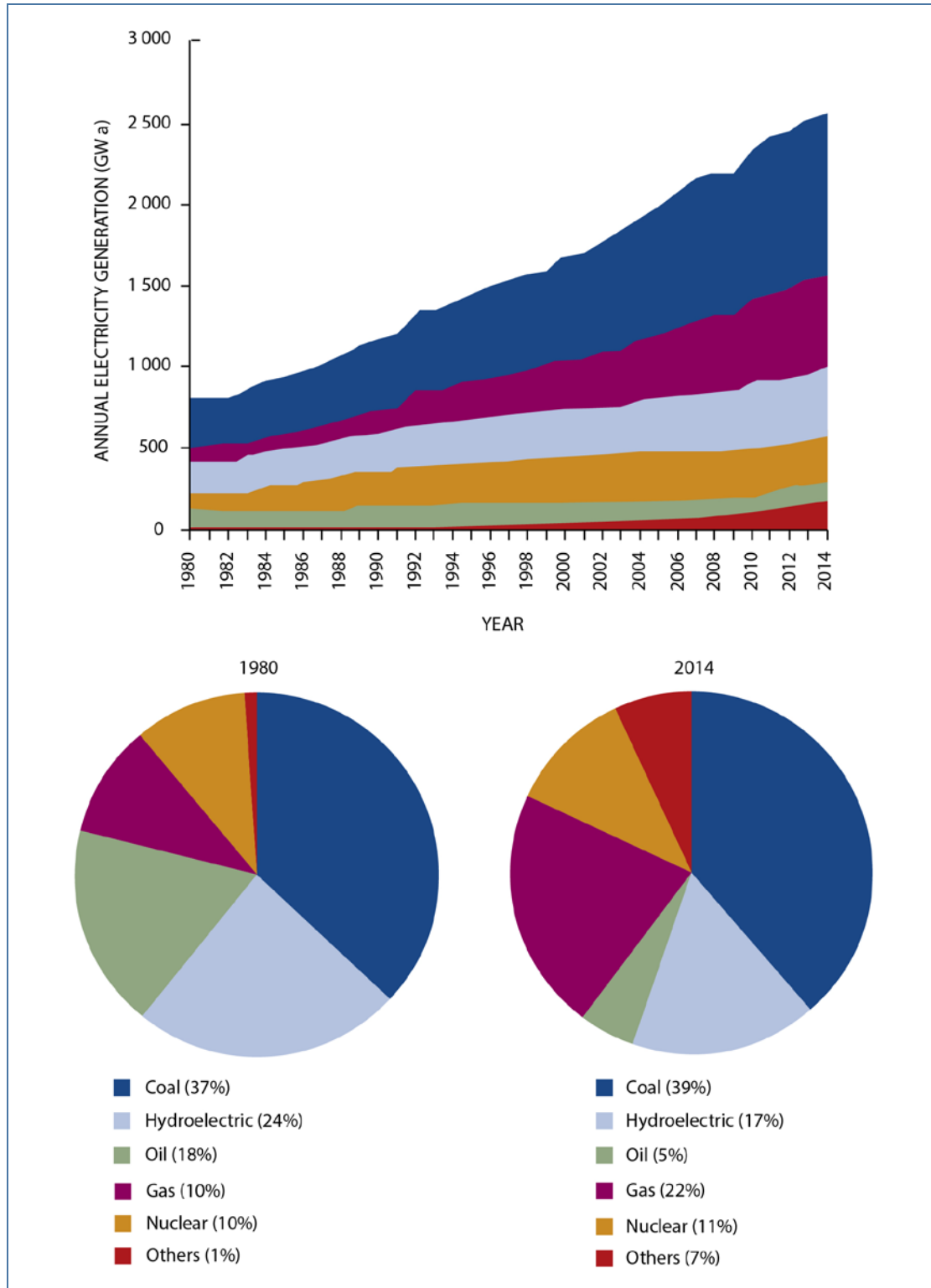

## B. Electricity generation worldwide in 2010

18. The reference year for assessments presented in this annex is 2010. Table 2 and figure II summarize worldwide electricity generation in 2010 [I15]. Total electricity generation worldwide in 2010 is reported as 2,452 GW a (table 2), which also shows the contribution by type for the six geographical regions of the world as adopted by the United Nations Environment Programme (UNEP). These regions are the same as those used in annex A. Marginally different values for electricity generated by nuclear power in 2010 were obtained from IAEA [I6] and used in the application of the revised methodology for estimating public exposures due to radioactive discharges (annex A). The IAEA database [I6] provided detailed data on electricity generated in 2010 both by region and as a function of reactor type; these data were not used to generate table 2, but were used in the more detailed assessments discussed in chapter IV.B.2.

19. Total annual average worldwide electricity generated from nuclear power plants 1998–2002 was reported as 278 GW a in table 16 and table A-5 from [U11], which can be compared to 314 GW a for 2010.

Table 2. Summary of worldwide electricity generated in 2010

Supporting values were manipulated with full precision and any discrepancies in the numbers presented are due to rounding

Type	Electricity generated in 2010 (GW a) [I15, I16]						
	Africa	Asia and Pacific	Europe	Latin America and Caribbean	North America	West Asia <sup>a</sup>	Total
Nuclear <sup>b</sup>	1.38	66.4	137.4	3.14	106.0	—	314.3
Coal	29.6	567.7	150.6	6.26	237.4	0.00	991.6
Gas	22.7	146.9	177.0	35.8	122.0	39.4	543.8
Oil	9.26	36.9	12.8	20.2	6.33	27.1	112.6
Geothermal	0.17	3.19	1.28	1.13	2.00	—	7.77
Solar	0.06	0.68	2.62	0.03	0.47	0.00	3.86
Wind	0.23	8.80	17.4	0.14	11.9	0.00	38.5
Biomass	0.09	5.95	17.3	4.85	9.59	0.00	37.8
Hydro	12.4	128.6	105.3	80.9	72.7	0.94	400.8
Tide	—	—	0.11	0.02	0.00	—	0.13
Other	—	0.00	0.55	—	0.10	—	0.65
Total	76	965	622	153	569	67	2 452

<sup>a</sup> The numerical entry 0.00 corresponds to no electricity generated and the entry — corresponds to no data available. West Asia is omitted in all tables generated from the assessments reported in this annex, except for the assessments on gas and oil.

<sup>b</sup> Marginally different values, obtained from IAEA [I6], were used in the application of the revised methodology for estimating public exposures due to radioactive discharges (annex A) for the electricity generated by nuclear power in 2010.



Figure II. Breakdown of the electricity generated worldwide in 2010 by generation technology

Derived from data in table 2 (excluding contributions from "Tide" and "Other". Supporting calculations were made to full precision and any discrepancies in the final numbers are due to rounding

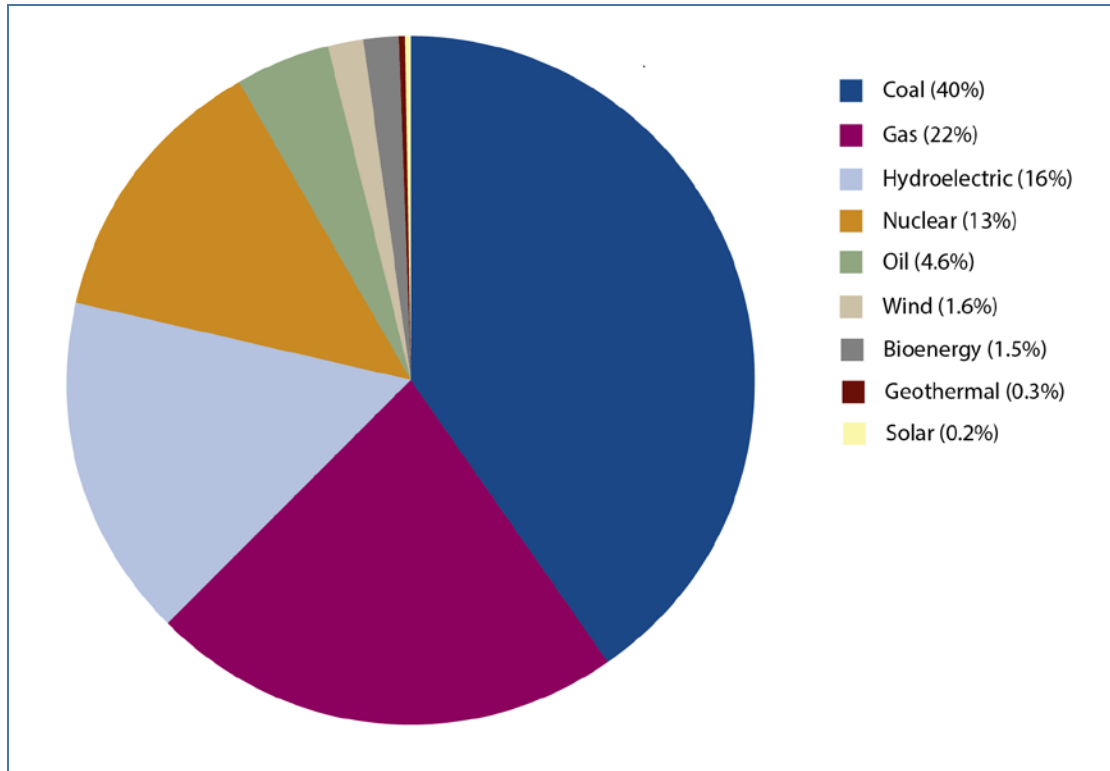

### III. ASSESSMENT APPROACH AND END POINTS

20. The main end point in this annex is an assessment and comparison of collective doses, and collective doses normalized to the electricity produced, for one year of different electricity-generating technologies, using consistent assessment approaches. To this end, the dominant exposure pathways for each of the electricity-generating technologies considered in this study have been assessed.

21. The Committee conducted this study by investigating sources of exposure from electricity-generating technologies based on (a) nuclear power, (b) the combustion of coal, natural gas, oil and biofuels, and (c) geothermal, wind and solar power. Two electricity-generating technologies (nuclear power and combustion of coal) were investigated in detail, because a more robust database existed for these technologies. The Committee evaluated the main sources of radioactive discharges from the life cycle of these electricity-generating technologies. For nuclear power, these sources included uranium mining and milling, mill tailings, power plant operation and reprocessing activities. For combustion of coal, they were the mining for coal, power plant operation for a prototype of both a modern coal plant and an older-style coal plant, and deposits of coal ash. These sets of sources will hereafter be called the "nuclear fuel cycle" and "coal cycle", respectively, for simplicity.

22. The Committee pursued two paths for the assessments presented in this annex. First, UNSCEAR's revised methodology for estimating public exposures due to radioactive discharges (annex A) was used to assess components of exposure due to electricity generation from the nuclear fuel cycle and from the coal cycle in a consistent manner. These two technologies were chosen for substantive treatment, because reasonably reliable input data existed and, from previous assessments, they were known to be important. The use of a common methodology for these assessments allowed consistent comparison of estimated exposures from the two technologies. A significant end point to these assessments was to identify and discuss dominant sources of exposure from these two electricity-generating technologies, and the dominant radionuclides contributing to those exposures.

23. The second path was to derive reasonable estimates of public exposures arising from the other electricity-generating technologies, and occupational exposures from all the electricity-generating technologies considered. This permits a rough comparison of the total human exposure from each of the electricity-generating technologies normalized to the energy generated by each technology.

24. For those electricity-generating technologies relying on power plants that burn natural gas or oil as fuel, and power plants driven by geothermal energy, an important exposure pathway is radon gas discharged to atmosphere. The Committee's revised methodology for estimating public exposures due to radioactive discharges (annex A) has been used for assessing atmospheric discharges from these technologies.

25. The revised methodology (annex A) was designed for assessing public exposures from routine releases of radionuclides to the environment during normal operations, and not for assessing occupational exposures. Thus, occupational exposures due to electricity generation from the nuclear fuel cycle and from the coal cycle have been assessed here primarily from data on occupational exposure from the UNSCEAR 2008 Report [U11], adjusted for electricity generated in 2010. In some cases, particularly occupational exposures from mining for coal and uranium and other metals, relevant new data have been obtained and estimates of dose commitments have been updated for 2010. Occupational exposures from the mining of metal ores needed for the construction of power plants or power-generating equipment have been assessed and compared for the various electricity-generating technologies.

26. Assessments have also been made of collective effective doses for the entire decommissioning phase of nuclear power plants based on available data on occupational exposures from existing decommissioned plants.

27. Exposures of the public and workers due to radioactive materials from conventional hydroelectricity generation were not included in this annex. This is because no radioactive materials are discharged during normal operations, and the magnitude of discharges of radioactive materials and resulting exposures when constructing dams were deemed negligible when compared to other exposures (for example, the mining of metals or mining for other fuels, such as coal or uranium). The main exposure situation associated with hydroelectricity generation was considered to be occupational exposure during the mining of metals needed for construction of the power plants. However, this exposure was not evaluated because hydroelectric plants have considerable variation in their size, leading to large uncertainties when adopting a standard plant design for assessment.

28. Finally, the total exposures during one year, including both public and occupational, for each electricity-generating technology (nuclear fuel cycle, coal cycle, oil, natural gas, geothermal, solar and wind), have been compared. Three main phases that contribute to the total exposure of the public and workers for each technology have been considered: preparation, operation and decommissioning. For all discharges, the same methodology has been used to estimate public exposures—a significant improvement over the Committee's earlier assessments.

## A. Recapitulation of key features of the methodology for estimating public exposures due to radioactive discharges

29. The following paragraphs recapitulate some of the key features of the methodology described in annex A that are relevant for the assessment here.

30. *World-average.* This term is used to qualify data that are intended to represent a value averaged across the whole world. For example, for the default population distributions (shown in table 3 of annex A), the world-average population for a distance band is derived from the average of the values for the distance band within each UNEP region, weighted by the population in each region. Similarly, world-average consumption rates for terrestrial and aquatic foods are derived from the values for each UNEP region weighted by the populations in each region.

31. *Dose.* In all cases and unless otherwise stated, dose refers to the protection quantity, effective dose. The annual effective dose is the sum of the dose from external exposure in that year plus the committed dose from intakes by inhalation and ingestion in that year. For doses integrated over a period, it is the sum of integrated doses from external exposure over the period and committed doses from the integrated intakes by inhalation and ingestion over the period. Doses to the public are only estimated for adults and the period considered for the committed dose is 50 years, i.e. adult ages from 20 to 70 years.

32. *Characteristic individual dose.* The individuals considered are those living in the area local to the point of discharge with behaviour indicative of the majority of people living in that area. The dose to these characteristic individuals is referred to here as the “characteristic individual dose”.

33. For discharges to atmosphere, the characteristic individuals were assumed to live 5 km from the discharge point and to obtain 25% of their food from this distance. For discharges to rivers, the characteristic individual was assumed to be exposed to riverbank sediment 5 km downstream from the discharge point, to drink all of their water from the river, and to eat 25% of the freshwater fish in their diet from the river plus 25% of their dietary grain and leafy vegetables irrigated with water from the river. For discharges to marine environments, the characteristic individual was assumed to be exposed to external irradiation from radionuclides in sediments from the local marine compartment using a factor to represent average occupancy of beaches. The characteristic individual is also assumed to consume marine foods with 25% of their dietary fish from the local marine compartment and 75% from the regional compartment, while 100% of the dietary consumption of crustacea and molluscs were assumed to be from the local compartment. In all cases the consumption rates used were the average for a population. These assumptions are discussed in detail in annex A.

34. *Collective doses.* The standard collective dose calculated here is the integrated dose to 100 years from one year’s discharge. (For the modelling of the globally-circulating radionuclides, collective doses integrated to 500 and 10,000 years are also calculated, see paragraph 39.) The end point for all radionuclides calculated in annex A was the collective dose per unit discharge integrated to 100 years. For releases to atmosphere, the local and regional components of the collective doses derive from doses to populations within a distance of 1,500 km from the discharge point and are based on four different types of population distributions:

(a) *A default population distribution based on population densities for 2010.* Values of population density are given for six different regions (as adopted by UNEP) and also a world-average value (a population-weighted average of the population density for the UNEP regions). These are used to assess collective doses due to discharges from the coal cycle, combustion of gas and oil, and geothermal energy.

(b) *The population distribution around nuclear power stations situated on the coast.* Values of the average population within distance bands around coastal nuclear power stations are given for five regions as adopted by UNEP (but not West Asia because there was no operating nuclear power station in this region at the time of the assessment) and also an average value for the world. The population densities were based on data for coastal sites of actual nuclear power stations throughout the world and the distributions are arithmetic means of the data for distance bands around each coastal site located in the region of interest.

(c) *The population distribution around nuclear power stations situated inland.* Values of the average population within distance bands around inland nuclear power stations are given for four regions as adopted by UNEP (but not Africa or West Asia because there were no operating nuclear power stations located inland in these regions at the time of the assessment) and also an average value for the world. The population densities were based on data for inland sites of actual nuclear power stations throughout the world and the distributions are arithmetic means of the data for distance bands around each inland site located in the region of interest.

(d) *A single value of population density for remote sites of  $5 \text{ km}^2$ .* This is used to assess collective doses due to discharges from uranium mines and mill tailings, which are located in areas of very low population density. This value is also used in an alternate calculation to assess collective doses due to discharges from geothermal sites. Values for regions of the world are not provided for these cases.

35. For releases to atmosphere, a distinction could be made between the local component of collective dose (to populations within a distance of 100 km) and a regional component of the collective doses (to populations between 100 and 1,500 km). For aquatic releases to rivers and lakes, it was not possible to distinguish between local and regional components of the collective dose because of the method used to calculate collective dose. However, for discharges to marine environments, local and regional compartments were used to model the dispersion of the released radionuclide, and therefore local and regional components of the collective doses could be provided. Note that the use of the word “regional” here is distinct from its potential use as a qualifier meaning “related to the geographical regions adopted by UNEP”.

36. *Globally-circulating radionuclides.* Four radionuclides ( $^3\text{H}$ ,  $^{14}\text{C}$ ,  $^{85}\text{Kr}$  and  $^{129}\text{I}$ ) were assumed to become globally circulated and to continue to expose the world population for decades and, with regards to  $^{14}\text{C}$ , centuries, and  $^{129}\text{I}$ , millions of years. These radionuclides contribute to the local and regional component of collective dose when they are initially discharged (due to the so-called “first pass”) and this component was modelled as for all other radionuclides. However, a global component needs to be added separately for these radionuclides. Thus, an additional collective dose due to global circulation was also modelled and results calculated. Results of the global model are provided for discharges to atmosphere and to marine environments; for aquatic discharges to freshwater systems, the results were assumed identical to those for a marine environment for the purposes of calculating the global component of collective dose.

37. *Integration times.* The methodology applies to discharges that can be assumed to be continuous. Account is taken of the build-up of long-lived radionuclides in the environment and the associated continued exposure after the discharges have stopped. This is done by considering a year’s discharge of a radionuclide, its dispersion in the environment and the subsequent exposure of people over many years; the resulting dose rates are then integrated. A value of 100 years is used for the integration period for the standard case (see further details in annex A).

38. Using the integrals it is also possible to consider that the discharges continue for many years from the same site. This is because the integrated dose to 100 years from one year’s discharge is numerically

equal to the dose in the 100th year from a continuous discharge at a constant rate over a 100-year period. The characteristic individual doses are calculated by integrating dose rates to 100 years, which also represent the annual dose that would be received in the 100th year of discharge.

39. Collective doses can be integrated to various times, but for most radionuclides it was sufficient to integrate to 100 years because most of the collective dose commitment (i.e. the collective dose theoretically integrated to infinity) is delivered during this period. However, for globally-circulating radionuclides (i.e.  $^3\text{H}$ ,  $^{14}\text{C}$ ,  $^{85}\text{Kr}$  and  $^{129}\text{I}$ ), the integrated collective dose continues to increase for many years beyond 100 years (see annex A, paragraph 14). Therefore, for globally-circulating radionuclides, collective doses integrated to 500 and 10,000 years were also calculated.

40. The main results of the revised methodology (annex A) are for a unit discharge for one year integrated to 100 years and can be used to estimate the impact of one-year's practice by, for example, scaling the results by the discharge of radionuclides per unit of electricity generated, or the total discharges from a particular type of electricity generation.

41. *Waste residues from uranium mining and from coal-fired power stations.* These wastes, uranium mill tailings and coal ash, are often disposed of on the surface of the ground and they contain enhanced levels of naturally occurring radionuclides, notably  $^{226}\text{Ra}$  which decays into the gas  $^{222}\text{Rn}$ , which can be emitted into the air for many years after the disposal occurs. The radon and its decay products give rise to human exposure (see figure III).

42. In this case one-year's practice gives rise to a continuing discharge to atmosphere for many years. Current best practice would rehabilitate mill tailings such that emissions were reduced to background levels (i.e. the levels that would occur from that area if the mine had not been present). Information from Australia and elsewhere indicates that this process might take some 50 years and that monitoring is expected to continue for some 20 to 30 years to ensure that the rehabilitation has been successful and to monitor for any deterioration [S2, W1]. The question remains whether the site could deteriorate once institutional control has finished, and radon emissions increase again. A base case integration time of 100 years seems reasonable with 10,000 years a cautious upper estimate.

43. Therefore, for radon discharges from land disposal of mill tailings or coal ash, allowance has to be made for this continued discharge and this was done by multiplying the results for one year's discharge by 100 to allow for the discharge continuing for 100 years (see annex A, paragraph 17). This 100-year multiplication is chosen for both individual and collective doses because 100 years is not much different from a human lifetime. The Committee has also considered the effect on the integrated collective dose of a continuing discharge for 500 and 10,000 years.

Figure III. The  $^{238}\text{U}$  and  $^{232}\text{Th}$  decay series

Half-life is expressed in a = year; d = day; h = hours; m = minutes; s = seconds

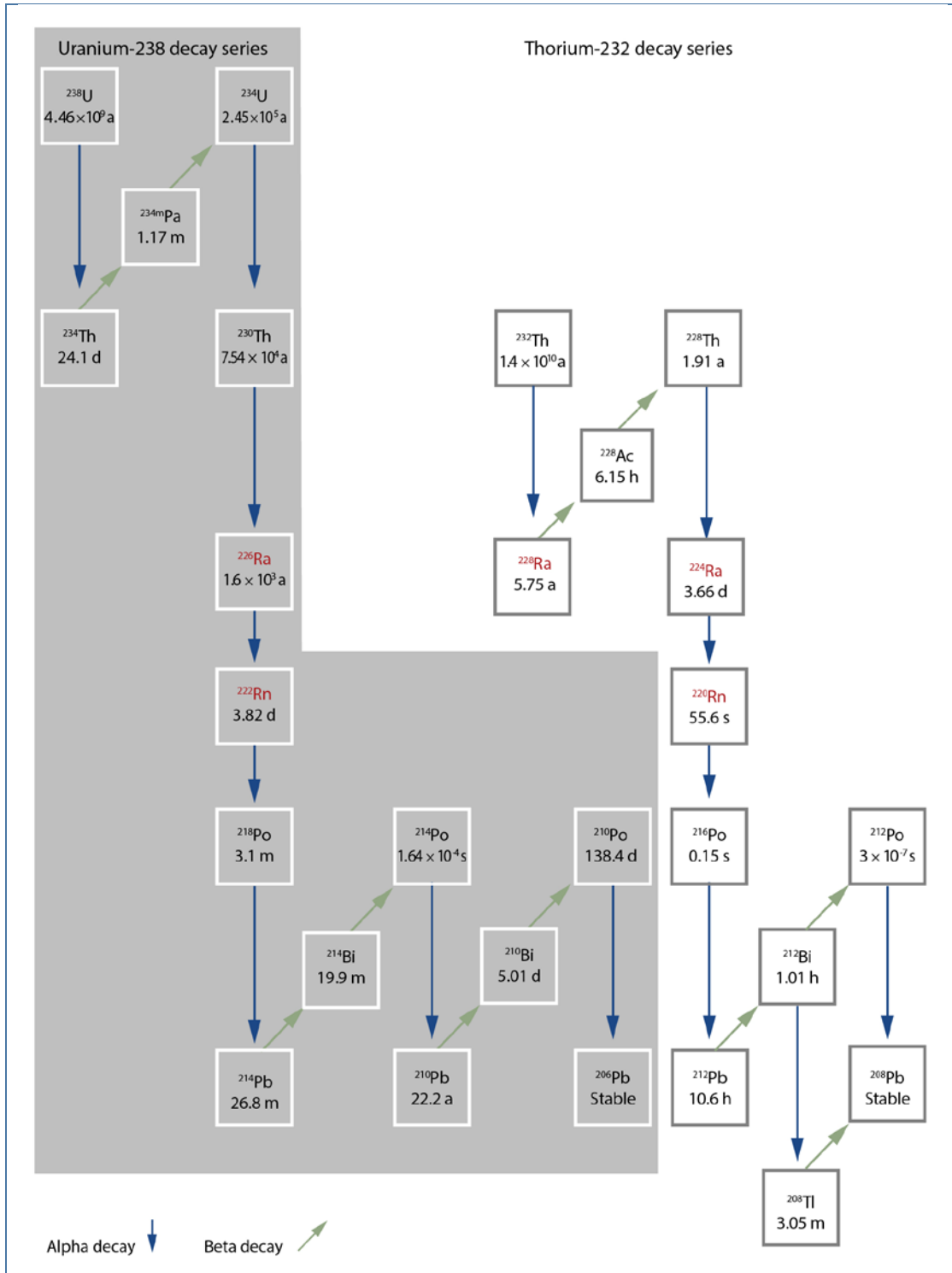

44. *Representative radionuclides for nuclear power plants.* Discharges of radionuclides from nuclear power plants are commonly reported by operators and regulatory bodies aggregated in groups. For example in UNSCEAR 2008 discharges were reported as “noble gases” and “particulates” for atmospheric discharges, or “other nuclides” for liquid discharges. Accurate assessments of doses can only be carried out on a radionuclide-specific basis and so where groups of radionuclides had been reported, it was necessary either to apportion the discharge for the groups of nuclides among the radionuclides, or to use a “representative” radionuclide. The European Commission [E1] gives the percentage of radionuclides discharged for different reactor types sited in Europe for different groupings. For AGRs, FBRs and GCRs,<sup>4</sup> the discharges were split between the radionuclides considered in the workbooks for the appropriate groupings (atmospheric noble gases, atmospheric particulates and other liquids). The breakdown for GCRs was based on United Kingdom sites because these were the only ones operational in 2010. For atmospheric particulate discharges from BWRs and PWRs, <sup>54</sup>Mn was selected as the representative radionuclide for any radionuclides not considered explicitly in the workbooks. The grouping of “other liquids” did not previously include <sup>14</sup>C and, for many countries and most reactor types, liquid discharges of <sup>14</sup>C are not reported. However, examination of EC RADD [E2] shows that for European PWRs liquid discharges of <sup>14</sup>C are significant and therefore 30% of discharges from “other liquids” were assumed to be <sup>14</sup>C for PWRs. For BWRs and PWRs any liquid discharges for radionuclides not included in the workbooks were allocated equally between <sup>54</sup>Mn and <sup>58</sup>Co. For HWRs, <sup>41</sup>Ar, <sup>60</sup>Co and <sup>137</sup>Cs were assumed to represent discharges for noble gases, atmospheric particulates and other liquids respectively, based on information in [B3, B5, C2]. For LWGRs information was taken from the EC RADD database [E2].

## IV. RADIATION EXPOSURES ARISING FROM ELECTRICITY GENERATION BY NUCLEAR POWER

### A. Introduction

45. The Committee has studied radiation exposures arising from electricity generation by nuclear power repeatedly over the years since its first publication on this subject in 1958 (see especially [U6, U7, U8, U9, U11]). These studies have consistently shown that the major contribution to public exposures has been through the discharges of natural radionuclides, primarily from: radon and its progeny released during uranium mining and milling, and from mill tailings, associated with the nuclear fuel cycle; and from carbon-14, primarily associated with reactor operation and fuel reprocessing.

46. The revised methodology for estimating public exposures due to radioactive discharges (annex A) has been used here to assess public exposures from the following processes: uranium mining and milling; electricity generation from nuclear power reactors; and fuel reprocessing. The assessments and results for these processes are presented in the following section. The processes—uranium enrichment, fuel fabrication and solid waste disposal—and their exposure characteristics are discussed in sections

---

<sup>4</sup> The following abbreviations are used for the different nuclear power reactor types, categorized according to their coolant systems and moderators: light-water-moderated and cooled pressurized or boiling-water reactors (PWRs and BWRs); heavy-water-cooled and moderated reactors (HWRs); gas-cooled, graphite-moderated reactors (GCRs and AGRs); light-water cooled, graphite-moderated reactors (LWGRs); and the liquid metal cooled fast-breeder reactors (FBRs).

IV.B.4 and IV.B.5, and dose estimates for these processes that were published in the UNSCEAR 2008 Report [U11] have been used here. This chapter begins with the assessment of public exposures, followed by that of occupational exposures, and ends with considering the occupational exposures associated specifically with the decommissioning process.

## B. Public exposure

### 1. Mining and milling

47. Uranium ore can be extracted from the earth by physically removing it through conventional surface or underground mining methods or by chemically dissolving the uranium out of the rock ore through either heap leaching or in-situ leaching (ISL) (sometimes referred to as in situ recovery or ISR) [U18]. Surface mining (also referred to as opencast, open pit or strip mining) techniques are applied to ore bodies that are close to the surface, and are also a generally cost-effective method for extracting large volumes of lower-grade ore, that may then be combined with other bulk extraction techniques (such as conventional milling, leaching and extraction, or alternative techniques such as heap leaching) which would be uneconomical for underground operations. Underground mining involves extracting rock through a tunnel or opening in the side of a hill or mountain and is generally applied for the extraction of higher-grade ores. In-situ leaching is generally applied to shallow deposits that exist in non-porous shale or mudstone, or in situations where uranium can be recovered from otherwise inaccessible or uneconomical formations [U18].

48. Uranium ores typically contain from about 0.05 to 0.3% uranium oxide ( $U_3O_8$ ) [U18]. After extraction from the ground, the mined uranium ore is sent to a mill, which is usually located close to the mine. This next step in the nuclear fuel cycle, called “milling”, involves the extraction and purification of uranium from the uranium ore. After a first purification process, the uranium is precipitated in a partially refined form, known as “yellowcake”. The uranium concentrate, typically containing 75 to 95% uranium, is shipped to a chemical plant for further purification and chemical conversion [B4].

49. In-situ leaching is an alternative method for extracting uranium from low-grade ores or shallow deposits that exist in non-porous shale or mudstone. An ISL plant chemically alters the uranium ore underground before it is pumped out for processing. In the ISL process, wells are drilled into rock containing uranium ore. An alkaline or acidic solution (known as lixiviant) is injected down the wells to dissolve the uranium in the rock. In the case of alkaline solutions, the lixiviant is usually (a) water mixed with oxygen and/or (b) hydrogen peroxide mixed with sodium carbonate or carbon dioxide. In the acid leach processes (used in Kazakhstan and Australia), sulphuric acid usage can result in lixiviant solutions with pH as low as 1 being circulated into the ore body (the process in Kazakhstan is typically strongly acidic, while in Australia only mildly acidic). In some cases, an oxidant is added to increase the efficiency of leaching. The lixiviant is then collected in a series of recovery wells, through which it is pumped to a processing plant. At the processing plant, the uranium is extracted from the solution through an ion-exchange process, and the uranium oxide concentrate (yellowcake) is then precipitated, dried and packed.

50. After recovery of the uranium, the barren solution is re-fortified with oxidant (if required) before being returned to the well field via the injection wells. However, a small flow (about 0.5%) is bled off to maintain a pressure gradient in the well field and this, with some solutions from surface processing, is treated as waste. This waste water contains various dissolved ions such as chloride, sulphate, sodium, radium, arsenic and iron from the ore body and is re-injected into approved disposal wells in a depleted



portion of the ore body. Wells must be monitored to ensure that extraction fluids do not leave the facility or contaminate groundwater. Waste from this process, usually filters and piping, can be disposed in a tailings pile at a mill site or a licensed disposal facility. In-situ leaching facilities have no radon discharge during the “mining” phase, and no surface tailings and little radon emission after closure [U11]. There can however be discharge of radon during the “leaching” phase of the ISL mining process, which here has been assumed to be the same as the radon discharge occurring during the milling phase [B6, B7]. Chapter IX discusses the need for further study regarding the ISL mining process.

51. In 2014, 51% of the world’s uranium was mined using ISL operations, a share that has risen steadily mainly because of mining operations in Kazakhstan [W8]. Table 3 shows the percentage contribution from ISL-mining to total uranium production during the period from 2008 to 2012 in each of the UNEP regions. For the reference year of 2010 used in this annex, the total uranium production for 15 countries is given in table 4.

Table 3. Contribution of ISL-mining to total uranium production between 2008 and 2012

Information on percentage ISL compared with other types of mining is taken from [W10]

Region	Contribution to world production (%)		
	Total	ISL	Others
Asia and Pacific	51.6%	38%	13.6%
North America	21.1%	2%	19.1%
Africa	18.4%	0%	18.4%
Europe	8.6%	1%	7.6%
Latin America	0.3%	0%	0.3%
World	100%	41%	59%

Table 4. Uranium production in 2010 [O8]

The production numbers come from OECD/NEA (table 1.21, page 60, Historical uranium production [O8]). Countries that had a label “Secretariat estimate” are not included here (Pakistan, Romania and India). Also excluded are a few countries that had very small production which came from mine rehabilitation efforts only

Country (UNEP region)	Uranium production (t U)
Kazakhstan (Asia and Pacific)	17 803
Canada (North America)	9 775
Australia (Asia and Pacific)	5 900
Namibia (Africa)	4 503
Niger (Africa)	4 197
Russian Federation (Europe)	3 563
Uzbekistan (Asia and Pacific)	2 874
United States (North America)	1 630
China (Asia and Pacific)	1 350

<i>Country (UNEP region)</i>	<i>Uranium production (t U)</i>
Ukraine (Europe)	837
Malawi (Africa)	681
South Africa (Africa)	582
Czech Republic (Europe)	254
Brazil (Latin America)	148
Iran, Islamic Rep. of (Asia and Pacific)	7
<b>Total</b>	<b>54 104</b>

### (a) *Input to assessments for mining and milling*

52. The Committee's revised methodology for estimating public exposures due to radioactive discharges (annex A) has been used to assess the collective doses and characteristic individual doses from four categories of sources for radon discharges:

- (a) Mining (underground uranium mining)
- (b) Milling (natural radionuclides other than radon are also discharged)
- (c) Operational mill tailings
- (d) Mill tailings

53. The third category, operational mill tailings, refers to the mill tailings produced during the milling process, and the fourth category, mill tailings, represents the tailings that are positioned in some other place for more permanent holding. They can be eventually treated or mitigated to reduce the discharge of radionuclides. Assessments were conducted using the methodology described in annex A for the four categories of sources above. They were performed using the discharges normalized to energy generated shown in table 5 and table 6, and the values for electricity generation for each region given in table 7 to estimate characteristic individual doses to the public. As noted in the tables, many of the values for the normalized discharges were taken from previous UNSCEAR reports. However, the estimate for the discharge of radon from mill tailings has been updated. A value for the discharge of radon per energy produced of 0.3 TBq/(GW a), based on a tailings area of 1 hectare and a radon emanation rate of 1 Bq s<sup>-1</sup> m<sup>-2</sup>, was used in [U9]. This was lower than the previous value of 1 TBq/(GW a). Information on emissions from Australian mine tailings [L2] is that the value of 1 Bq s<sup>-1</sup> m<sup>-2</sup> is high compared to the range of levels that are measured. Measurements taken over a number of years at the El Sharena mines were in the range 9–36 mBq s<sup>-1</sup> m<sup>-2</sup> with an average baseline value of 17 mBq which is equivalent to 0.005 TBq/(GW a) based on a tailings area per electricity generated of 1 ha/(GW a). In other cases where the tailings have been rehabilitated, the emissions rates are at background levels. A study at the Ranger uranium mine found that the emission rates ranged from 0.2 to about 0.9 Bq s<sup>-1</sup> m<sup>-2</sup>. The studies related to trial landforms intended to develop their rehabilitation strategies with the aim of reducing the long-term radon emission rates. For Olympic Dam, an emission rate of 0.5 Bq s<sup>-1</sup> m<sup>-2</sup> was published, a value equivalent to 0.15 TBq/(GW a) while other information gives emission rates of 0.3, 0.14 and 0.04 Bq s<sup>-1</sup> m<sup>-2</sup> for the inner mine, outer mine and region. These are equivalent to 0.1, 0.04 and 0.01 TBq/(GW a) based on 1 ha/(GW a). These Australian values indicate that the UNSCEAR 2000 value (0.3 TBq/(GW a)) may be too high based on mines operating with best practice for which a value of 0.1 or lower may be more appropriate. In the light of this, the Committee agreed that a rounded emission rate of 0.1 TBq/(GW a) should be used in this study.

Table 5. Discharges of radon from the uranium mining and milling process normalized to electricity generated

<i>Source</i>	<i>Normalized discharges (TBq/(GW a))</i>
Mining (world average, all mines except ISL, only radon discharges)	66 <sup>a</sup>
Mining (world average, all ISL mines, only radon discharges from leaching phase of ISL mining process)	3
Milling (world average, all mines, radon discharges plus nuclides in table 6)	3 <sup>b</sup>
Operational mill tailings (world average, all mines except ISL, only radon discharges)	3 <sup>c</sup>
Mill tailings (world average, all mines except ISL, only radon discharges)	0.1 <sup>d</sup>

<sup>a</sup> A value of 75 TBq/(GW a) was used in earlier UNSCEAR assessments [U8], and was based on the assumption that there were on average 300 GBq of radon released per tonne of uranium oxide [U8].

<sup>b</sup> From UNSCEAR 1993 Report [U8].

<sup>c</sup> From UNSCEAR 2000 Report [U9].

<sup>d</sup> From annex A.

Table 6. Airborne discharges during the milling process (all mines including ISL) ([U8] tables 19 and 22)

<i>Radionuclide</i>	<i>Activity discharged per unit of electricity generated (TBq/(GW a))</i>
<sup>210</sup> Po	$2 \times 10^{-5}$
<sup>210</sup> Pb	$2 \times 10^{-5}$
<sup>226</sup> Ra	$2 \times 10^{-5}$
<sup>234</sup> U	$4 \times 10^{-4}$
<sup>238</sup> U	$4 \times 10^{-4}$
<sup>230</sup> Th	$2 \times 10^{-5}$

54. The estimate for the discharge of radon from uranium mining (non-ISL mines) has also been updated. Total uranium production in 2010, shown in table 4 [O8], was assumed to be the amount that was mined in that year. Values were summed for all countries to give a rounded total of 54,100 tonnes of uranium. Similarly, total uranium production in 2010 from table 4 is assumed to equal the total amount of uranium milled. The value for the mass of uranium required per unit of electricity generated given in the UNSCEAR 2008 Report was 220 t/(GW a) ([U11] table 18A), which is lower than the value of 250 t/(GW a) used earlier by the Committee [U7, U8, U9]. The trend in uranium required per unit of electricity generated (the uranium requirement) is generally downwards, because of increasing efficiencies in power plant operation and lower enrichment tails assays. For example, the 2014 Red Book [O8] reported that the generic reactor uranium consumption had reduced from 175 t/GW(e) per year at 0.30% tails assay [O6] to 163 t/GW(e) per year at 0.25% tails assay. The corresponding figures for U<sub>3</sub>O<sub>8</sub> are 206 and 192 tonnes, respectively.

55. The value of 220 t/(GW a) used in the UNSCEAR 2008 Report is the value used in this assessment. Given the information in the previous paragraph, this is possibly a slight overestimate; however, it was retained for continuity with the previous UNSCEAR assessments. This gives a value for the discharge of radon from the mining process normalized to electricity generated of 66 TBq/(GW a), which is lower than the value of 75 TBq/(GW a) used in earlier UNSCEAR studies [U7, U8, U9].

56. In modern ISL facilities, the circulating lixiviant goes directly from the well field to the header houses and the dissolved uranium is extracted from the lixiviant through the ion exchange process. The lixiviant is then reconstituted and returned directly to the well field in an essentially closed (pressurized) system. In older non-pressurized systems (such as at Crow Butte, United States), the resin column is not pressurized, so the lixiviant is exposed to normal atmospheric conditions, which results in super-saturated radon being discharged. The discharged radon gas is vented through an exhaust stack to the atmosphere. This discharge is most similar to that from the milling phase, not from the mining phase. The assessments in this annex have assumed radon discharges during ISL uranium mining are the same as those from the milling phase.

57. In order to perform assessments of the characteristic individual doses to the public for each region, electricity generation in 2010—broken down into ISL and non-ISL mining sources—was needed for the different regions. Total uranium production for 15 countries in 2010 is given in table 4. Table 3 shows the contribution from ISL-mining to the total uranium production in each UNEP region between 2008 and 2012. Using the value for uranium requirement of 220 t/(GW a), the electricity generated from the total uranium production for each region could be estimated as shown in table 7. Assessments for mining and milling using the revised methodology for estimating public exposures due to radioactive discharges (annex A) used the values for total electricity generated with the normalized discharges for milling, the total electricity generation from ISL mining with the normalized discharges for ISL mining processes, and the total electricity generation excluding ISL mining sources with the normalized discharges for the processes mining (non-ISL), operational mill tailings and mill tailings, to calculate characteristic individual doses. Collective doses resulting from mining and milling were assessed assuming a low population density (defined in annex A), and no aquatic discharges were included in the assessment.

Table 7. Inferred electricity generation from the uranium production in each region and from ISL and non-ISL contributions

The assessment assumes 220 tonnes of uranium per gigawatt-year. Note that the total inferred electricity generation is 246 GW a, which is somewhat less than the world total nuclear electricity generation in 2010 at 314 GW a (table 2). However, this difference is not unreasonable because current reactor fuel requirements were met from primary supply (direct mine output: 78% in 2009) and secondary sources: commercial stockpiles, nuclear weapons stockpiles, recycled plutonium and uranium from reprocessing used fuel, and some from re-enrichment of depleted uranium tailings (left over from original enrichment) [O6, W11]

<i>Region</i>	<i>% of world production</i>	<i>% from ISL</i>	<i>% from other production methods</i>	<i>Mass of uranium from ISL (tonnes)</i>	<i>Mass of uranium from other production methods (tonnes)</i>	<i>Inferred electricity generated from ISL (GW a)</i>	<i>Inferred electricity generated from other production methods (GW a)</i>	<i>Total inferred electricity generated (GW a)</i>
Africa	18.4	0	18.4	0	9 954	0	45	45
Asia and Pacific	51.6	38	13.6	20 558	7 358	93	33	126
Europe	8.6	1	7.6	541	4 112	3	19	22
Latin America	0.3	0	0.3	0	162	0	1	1
North America	21.1	2	19.1	1 082	10 333	5	47	52
Total	100	41	59.0	22 181	31 919	101	145	246

## 2. Electricity generation from nuclear power reactors

58. The nuclear power reactors used for electricity generation that are treated here can be categorized according to their coolant systems and moderators: light-water-moderated and cooled pressurized or boiling-water reactors (PWRs and BWRs); heavy-water-cooled and moderated reactors (HWRs); gas-cooled, graphite-moderated reactors (GCRs and AGRs); and light-water cooled, graphite-moderated reactors (LWGRs). These reactor types are all thermal reactors that use the moderator material to slow down the fast fission neutrons to thermal energies. In fast-breeder reactors (FBRs), the coolant is a liquid metal, there is no moderator and fast neutrons induce fission.

### (a) *Assessments for nuclear reactor operation*

59. The distribution of electricity generated by geographic region and type of location of the nuclear power plants in the world are presented in table 8. The electricity generated in 2010 by nuclear power was about 300 GW a according to the IAEA PRIS database [I6] (table 9). PWRs contributed most to the total electricity generated worldwide from nuclear reactors (about 68%), followed by BWRs (about 21%) [I6]. The distribution of electricity generated by geographic region from nuclear power plants in 2010 by reactor type is shown in table 9. (The ordering of the individual reactor types in all relevant tables and figures in this annex is according to their world share of electricity generated in 2010, as shown in table 9.)

60. Radionuclide discharges and electricity generation data used with the revised methodology for estimating public exposures due to radioactive discharges (annex A), for assessing discharges from nuclear power plants in 2010 normalized to the electricity generated, are described in table 10. The main basis for deriving the normalized discharge values was the IAEA PRIS database [I6], the EC RADD database [E2] and the discharge data for the year 2002 in the UNSCEAR 2008 Report [U11]. Using these data the normalized discharges for 2002 were recalculated and adjusted to electricity generation in 2010, for use with the revised methodology for estimating public exposures due to radioactive discharges (annex A) to assess the exposures for the reference year 2010.

61. A summary of the activities of radionuclides, or radionuclide groups, discharged in airborne and liquid effluents from nuclear reactors during routine operation in 2010, normalized to the electricity generated in 2010, are reported in table 11. The method for determining how the aggregated nuclides were characterized, i.e. the noble gases and particulates in the atmospheric discharges, and the “other liquids” listed in the liquid discharges, has been addressed in earlier studies by UNSCEAR (e.g. [U7, U8, U9]). The aggregated nuclides were called “representative radionuclides for nuclear power plant discharges” in those studies, and the term “representative radionuclides” is used in this annex also. Chapter III.A, paragraph 44 in this annex explains how the representative radionuclides, were chosen for use in the current study with the revised methodology for estimating public exposures due to radioactive discharges (annex A) applied to nuclear power plants.

62. The revised methodology for estimating public exposures due to radioactive discharges (annex A) was used to assess doses due to discharges from nuclear power plants. The assessments considered atmospheric and aquatic discharges. Collective dose estimates for discharges to atmosphere were based on the population distributions around coastal or inland nuclear power plants, using the population distributions generated for the different regions adopted by UNEP (see annex A). Where appropriate, contributions from globally-circulating radionuclides were included in the assessment of collective

doses. The characteristic individual doses and collective doses were calculated separately for each of the reactor types (PWR, BWR, HWR, LWGR, AGR, GCR and FBR).

Table 8. Number of reactors by type, location and UNEP region (2010 data)

Data from the IAEA PRIS database [6]

<i>Reactor type</i>	<i>Africa</i>	<i>Asia and Pacific</i>	<i>Europe</i>	<i>Latin America and Caribbean</i>	<i>North America</i>	<i>Grand total</i>
PWR total	2	55	141	2	69	269
Coastal	2	54	34	2	16	108
Inland	0	1	107	0	53	161
BWR total	0	36	19	2	35	92
Coastal	0	36	9	2	2	49
Inland	0	0	10	0	33	43
HWR total	0	24	2	2	18	46
Coastal	0	11	0	0	1	12
Inland	0	13	2	2	17	34
LWGR total	0	0	15	0	0	15
Coastal	0	0	4	0	0	4
Inland	0	0	11	0	0	11
AGR (all coastal)	0	0	14	0	0	14
GCR total	0	0	4	0	0	4
Coastal	0	0	2	0	0	2
Inland	0	0	2	0	0	2
FBR (all inland)	0	0	2	0	0	2
Grand total	2	115	197	6	122	442

Table 9. Electricity generation from nuclear power plants in 2010 by reactor type and UNEP region (from [16])

The values for the total electricity generation from nuclear power plants for each UNEP region [19] are marginally different from those shown in table 2 [115]. The IAEA database [16] provided detailed data on electricity generation in 2010 both by region and as a function of reactor type, which was not available from the database used to generate table 2, and the more detailed data were therefore chosen for use in the assessments discussed in this chapter

Reactor type	Electricity generation (GW a)							% total per reactor type
	Africa	Asia and Pacific	Europe	Latin America and Caribbean	North America	West Asia	Total	
PWR	1.47	38.47	102.47	1.57	60.89	0.00	204.88	68
BWR	0.00	19.66	12.18	0.64	31.25	0.00	63.72	21
HWR	0.00	5.34	1.22	0.76	9.76	0.00	17.09	6
LWGR	0.00	0.00	8.15	0.00	0.00	0.00	8.15	3
AGR	0.00	0.00	5.01	0.00	0.00	0.00	5.01	2
GCR	0.00	0.00	0.93	0.00	0.00	0.00	0.93	0
FBR	0.00	0.00	0.42	0.00	0.00	0.00	0.42	0
Total	1.47	63.47	130.39	2.97	101.89	0.00	300.21	100

Table 10. Key data sources and assumptions used to assess public exposures due to radioactive discharges from nuclear power plants

Data sources	Commentary
Discharges, 2002	Taken from tables A6-A12 in UNSCEAR 2008 Report [U11]. Note that WWER was regrouped under PWR. Data for discharges from FBR are from 2001. Discharges of particulates to air and other liquids for United Kingdom AGRs/GCRs were taken from the EC RADD database [E2]
Electricity generation, 2002	Taken from [16]. Note that HWLWR was regrouped under HWR and PHWR under HWR. Generation data for FBR are from 2001
Electricity generation, 2010	Taken from [16]. Note that HWLWR was regrouped under HWR and PHWR under HWR. Includes a calculation of generation from reprocessing countries as a fraction of all generation
Countries	Countries and regions as adopted by UNEP (see annex A)
Location data	Inland/coastal location of reactors, taken from [16]
Normalized discharge data	For each reactor type: <sup>a,b</sup> the normalized discharges were scaled to the electricity generation ratio using the 2002 to 2010 electricity generation data; information summarized in paragraph 44 was used to apportion discharge between specific radionuclides; and location data were used to apportion between inland/coastal locations

<sup>a</sup> For FBRs, values of normalized discharges of  $^3\text{H}$ ,  $^{131}\text{I}$ ,  $^{14}\text{C}$ , liquid tritium and other liquids were taken from table 17, annex B, UNSCEAR 2008 Report [U11] because no discharge data were available. Data for the radionuclide mix were taken from [E1].

<sup>b</sup> For LWGRs, normalized discharge data were taken from table 17, annex B, UNSCEAR 2008 Report [U11]. EC RADD [E2] data for European LWGR reactors were used to infer mix of noble gases, particulates and other liquids.



Table 11. Estimated normalized discharges from nuclear power plants 2010

Reactor type	Estimated normalized discharges per unit of electricity generated (TBq per GW a)							
	Discharges to atmosphere						Aquatic discharges	
	Noble gases	Tritium	<sup>131</sup> I	<sup>14</sup> C	Particulates	<sup>35</sup> S	Liquid tritium	Other liquid
PWR	$5.8 \times 10^0$	$1.5 \times 10^0$	$8.0 \times 10^{-5}$	$8.3 \times 10^{-2}$	$3.6 \times 10^{-5}$	0	$1.8 \times 10^1$	$3.8 \times 10^{-3}$
BWR	$1.8 \times 10^1$	$1.3 \times 10^0$	$4.2 \times 10^{-4}$	$1.3 \times 10^{-1}$	$1.8 \times 10^{-3}$	0	$8.2 \times 10^{-1}$	$2.1 \times 10^{-3}$
HWR	$3.5 \times 10^1$	$2.0 \times 10^2$	$2.3 \times 10^{-5}$	$6.0 \times 10^{-1}$	$1.7 \times 10^{-5}$	0	$1.7 \times 10^2$	$3.1 \times 10^{-2}$
LWGR	$4.6 \times 10^2$	$2.6 \times 10^1$	$9.9 \times 10^{-3}$	$1.3 \times 10^0$	$2.7 \times 10^{-3}$	0	$7.8 \times 10^{-1}$	$2.0 \times 10^{-3}$
AGR	$1.9 \times 10^1$	$4.0 \times 10^0$	$3.2 \times 10^{-5}$	$1.4 \times 10^0$	$2.2 \times 10^{-5}$	$6.6 \times 10^{-2}$	$4.1 \times 10^2$	$8.1 \times 10^{-1}$
GCR	$1.7 \times 10^3$	$5.0 \times 10^0$	0	$5.5 \times 10^0$	$3.0 \times 10^{-4}$	$3.7 \times 10^{-1}$	$4.7 \times 10^0$	$1.2 \times 10^0$
FBR	$4.4 \times 10^1$	$4.9 \times 10^1$	$2.0 \times 10^{-4}$	$1.2 \times 10^{-1}$	$1.4 \times 10^{-4}$	0	$1.7 \times 10^0$	$2.3 \times 10^{-2}$

### 3. Fuel reprocessing

63. Reprocessing of used nuclear fuel has been practised for several decades in a number of countries, mainly for extracting and recycling fissile materials. Current recycling practices are primarily focused on the conversion of fertile<sup>5</sup> <sup>238</sup>U to fissile plutonium, for which a significant amount of the plutonium recovered from used fuel has been recycled into mixed oxide (MOX) fuel. Table 12 shows the current location of reprocessing facilities in the world, with operations in France, the Russian Federation and the United Kingdom dominating. Not shown in the table is the Rokkasho facility in Japan, which is expected to start operations in 2018 and to have a commercial reprocessing capacity of 800 tonnes per year. As of 2015, about 31% (90,000 tonnes of 290,000 tonnes) of used fuel from commercial power reactors has been reprocessed [W12].

64. Characteristic individual doses and collective doses were calculated for Sellafield in the United Kingdom, La Hague in France and Ozersk (Mayak) in the Russian Federation, which are also the three main reprocessing facilities (table 12), using available data on discharges. The doses due to discharges from fuel reprocessing facilities were assessed using the revised methodology for estimating public exposures due to radioactive discharges (annex A).

65. Data for both atmospheric and aquatic discharges were obtained for the reprocessing facilities at Sellafield, United Kingdom and La Hague in France for the year 2010 [E2] and for atmospheric discharges only at Ozersk (Mayak), Russian Federation [F2]. These data include discharges from other activities on site but it could be assumed that most discharges are related to reprocessing activities. Discharges normalized to electricity generation were calculated for La Hague based on the assumption that discharges from the reprocessing facility were related to the reprocessing of fuel equivalent to that required to power French PWRs in 2010, 47 GW a [I6, W9]. However, for Sellafield and Mayak it was not possible to relate the discharges to electricity generated.

<sup>5</sup> Fertile material is a material that is not fissionable by thermal neutrons, but can be converted into a fissile material by neutron absorption and subsequent nuclei conversions.

66. The discharges for reprocessing facilities are shown in table 13. Consequently, characteristic individual doses and collective doses (as defined in section III) could be assessed for all three of these facilities, all located in the region named Europe (as adopted by UNEP). However, because discharges normalized to electricity generation were only available for La Hague in France, the characteristic dose normalized to electricity generated could be assessed only for this facility. Collective doses normalized to electricity generation for Europe and the whole world were also based on La Hague, but took into account the fraction of electricity generated by all French PWRs in 2010 compared to Europe and the whole world, 0.55 and 0.24 respectively, for the calculation of the doses due to the first pass.

Table 12. World commercial reprocessing capacity [N1, O2, W12]

<i>Fuel type</i>	<i>Facility</i>	<i>Commercial reprocessing capacity (tonnes per year)</i>
LWR fuel	France, La Hague	1 700
	United Kingdom, Sellafield (THORP)	600
	Russian Federation, Ozersk (Mayak)	400
	Total LWR	approximately 2 700
Other nuclear fuels	United Kingdom, Sellafield (Magnox)	1 500
	India (PHWR, 4 plants)	330
	Japan, Tokai (MOX)	40
	Total other	approximately 1 870
Total civil capacity		approximately 4 570

Table 13. Discharges from reprocessing facilities [E2]

<i>Discharged radionuclide</i>	<i>Discharges to atmosphere</i>			<i>Aquatic discharges</i>		
	<i>Sellafield</i>	<i>La Hague</i>	<i>Mayak</i>	<i>Sellafield</i>	<i>La Hague</i>	<i>Mayak</i>
DISCHARGES PER UNIT OF ELECTRICITY GENERATED (TBq/(GW a))						
<sup>3</sup> H	—	$3.8 \times 10^4$	—	—	$6.7 \times 10^6$	—
<sup>14</sup> C	—	$1.1 \times 10^4$	—	—	$5.0 \times 10^3$	—
<sup>41</sup> Ar	—	—	—	—	—	—
<sup>54</sup> Mn	—	—	—	—	$1.4 \times 10^0$	—
<sup>58</sup> Co	—	—	—	—	$7.0 \times 10^{-2}$	—
<sup>60</sup> Co	—	$4.9 \times 10^{-3}$	—	—	$4.4 \times 10^1$	—
<sup>85</sup> Kr	—	$1.5 \times 10^8$	—	—	—	—
<sup>90</sup> Sr	—	—	—	—	$9.1 \times 10^1$	—
<sup>106</sup> Ru	—	$4.8 \times 10^{-2}$	—	—	$1.4 \times 10^3$	—
<sup>129</sup> I	—	$3.1 \times 10^0$	—	—	$9.3 \times 10^2$	—
<sup>131</sup> I	—	$1.6 \times 10^{-1}$	—	—	$7.9 \times 10^0$	—
<sup>135</sup> Xe	—	—	—	—	—	—

Discharged radionuclide	Discharges to atmosphere			Aquatic discharges		
	Sellafield	La Hague	Mayak	Sellafield	La Hague	Mayak
<sup>134</sup> Cs	—	$3.6 \times 10^{-3}$	—	—	$5.1 \times 10^1$	—
<sup>137</sup> Cs	—	$3.0 \times 10^{-3}$	—	—	$7.3 \times 10^2$	—
<sup>239</sup> Pu	—	$1.3 \times 10^{-3}$	—	—	$6.3 \times 10^0$	—
<sup>241</sup> Am	—	—	—	—	$1.3 \times 10^1$	—
AVERAGE DISCHARGE RATE OVER A YEAR (Bq/s)						
<sup>3</sup> H	$3.1 \times 10^6$	$1.8 \times 10^6$	—	$4.4 \times 10^7$	$3.2 \times 10^8$	—
<sup>14</sup> C	$8.7 \times 10^3$	$5.1 \times 10^5$	—	$1.4 \times 10^5$	$2.3 \times 10^5$	—
<sup>41</sup> Ar	—	—	$1.2 \times 10^6$	—	—	—
<sup>54</sup> Mn	—	—	—	—	$6.4 \times 10^1$	—
<sup>58</sup> Co	—	—	—	—	$3.3 \times 10^0$	—
<sup>60</sup> Co	—	$2.3 \times 10^{-1}$	$3.4 \times 10^{-1}$	$3.1 \times 10^3$	$2.0 \times 10^3$	—
<sup>85</sup> Kr	$1.4 \times 10^9$	$7.1 \times 10^9$	—	—	—	—
<sup>90</sup> Sr	$1.3 \times 10^0$	—	$4.2 \times 10^1$	$3.2 \times 10^4$	$4.2 \times 10^3$	—
<sup>106</sup> Ru	$2.4 \times 10^1$	$2.2 \times 10^0$	$5.7 \times 10^0$	$3.7 \times 10^4$	$6.5 \times 10^4$	—
<sup>129</sup> I	$3.1 \times 10^2$	$1.4 \times 10^2$	—	$8.7 \times 10^3$	$4.3 \times 10^4$	—
<sup>131</sup> I	$1.2 \times 10^1$	$7.7 \times 10^0$	$2.5 \times 10^1$	—	$3.7 \times 10^2$	—
<sup>135</sup> Xe	—	—	$1.8 \times 10^5$	—	—	—
<sup>134</sup> Cs	—	$1.7 \times 10^{-1}$	—	$3.5 \times 10^3$	$2.4 \times 10^3$	—
<sup>137</sup> Cs	$3.0 \times 10^0$	$1.4 \times 10^{-1}$	$2.1 \times 10^1$	$1.5 \times 10^5$	$3.4 \times 10^4$	—
<sup>239</sup> Pu	$6.2 \times 10^{-1}$	$5.9 \times 10^{-2}$	$1.3 \times 10^1$	$4.2 \times 10^3$	$2.9 \times 10^2$	—
<sup>241</sup> Am	$1.2 \times 10^0$	—	—	$1.1 \times 10^4$	$6.2 \times 10^2$	—

(a) *Results—public exposures from mining and milling, electricity generation from nuclear power reactors and fuel reprocessing*

67. Characteristic individual doses to the public—for the nuclear fuel cycle processes: mining and milling; electricity generation from nuclear power reactors; and fuel reprocessing—normalized to the electricity each process generated in 2010 are summarized in table 14. Doses for the characteristic individual from mining and milling are shown for both non-ISL and ISL mines. The characteristic individual was assumed to be located 5 km from the source. The doses represent the radiation exposure from all discharges in a year and, in the case of mill tailings, the doses are associated with those emissions for a period of 100 years (see chapter III).

68. The largest estimated characteristic individual doses normalized to electricity generation in 2010 for all discharges come from mining and milling activities in non-ISL mines in all regions, followed by operational discharges from nuclear power plants. Estimated characteristic individual doses from ISL mines are about an order of magnitude smaller than those from non-ISL mines, owing to the differences in radon discharges from the two processes. Estimated characteristic individual doses from mining and milling are primarily associated with radon exposures, while those from nuclear power plant operations reflect differences in the type and relative proportion of the different reactor types and thus different

radionuclide discharge mixes within a region, and to a lesser extent, variations in food consumption patterns across regions. Estimated characteristic individual doses for a region normalized to electricity generated that are associated with reprocessing are only reported for the region Europe, where the French, British and Russian reprocessing facilities are located. All of the estimated characteristic individual doses are very low.

Table 14. Summary of characteristic individual doses to the public normalized to electricity generated in 2010 for mining and milling, electricity generation from nuclear power reactors, and fuel reprocessing (mSv/(GW a))

Discharge type and source	Characteristic individual doses <sup>a,b</sup> to the public (mSv/(GW a))				
	Africa	Asia and Pacific	Europe	Latin America	North America
ATMOSPHERIC DISCHARGES					
Mining and milling <sup>c</sup> - non-ISL mines	$6.9 \times 10^{-3}$	$6.9 \times 10^{-3}$	$6.9 \times 10^{-3}$	$6.9 \times 10^{-3}$	$6.9 \times 10^{-3}$
Mining and milling - ISL mines	—	$5.5 \times 10^{-4}$	$5.5 \times 10^{-4}$	—	$5.5 \times 10^{-4}$
Power plants	$1.3 \times 10^{-5}$	$5.1 \times 10^{-5}$	$7.2 \times 10^{-5}$	$1.1 \times 10^{-4}$	$5.8 \times 10^{-5}$
Reprocessing	—	—	$5.7 \times 10^{-5}$	—	—
AQUATIC DISCHARGES					
Mining and milling - non-ISL mines	—	—	—	—	—
Mining and milling - ISL mines	—	—	—	—	—
Power plants	$7.0 \times 10^{-5}$	$1.5 \times 10^{-4}$	$1.2 \times 10^{-3}$	$1.5 \times 10^{-4}$	$5.0 \times 10^{-5}$
Reprocessing	—	—	$6.9 \times 10^{-4}$	—	—
TOTAL FOR ALL DISCHARGES					
Mining and milling <sup>c</sup> - non-ISL mines	$6.9 \times 10^{-3}$	$6.9 \times 10^{-3}$	$6.9 \times 10^{-3}$	$6.9 \times 10^{-3}$	$6.9 \times 10^{-3}$
Mining and milling - ISL mines	—	$5.5 \times 10^{-4}$	$5.5 \times 10^{-4}$	—	$5.5 \times 10^{-4}$
Power plants	$8.2 \times 10^{-5}$	$2.0 \times 10^{-4}$	$1.3 \times 10^{-3}$	$2.6 \times 10^{-4}$	$1.1 \times 10^{-4}$
Reprocessing	—	—	$7.5 \times 10^{-4}$	—	—

<sup>a</sup> The characteristic individuals are those living 5 km from the points of discharge with behaviour indicative of the majority of people living the area.

<sup>b</sup> It is only appropriate to present the characteristic individual doses for discharges normalized to electricity generated and not summations of the various individual dose values, because the same individuals cannot be exposed to all discharges from the various sources in each region. Because collective doses are the sum of all individual doses, they can be presented both as total collective dose and as collective dose normalized to electricity generated.

<sup>c</sup> The radon emissions from mill tailings produced per unit of electricity generated are assumed to continue for 100 years.

69. Collective doses to the public for discharges from mining and milling, power plant operation and reprocessing in 2010 are summarized in table 15, and in table 16 normalized to the electricity generated by each process for that year. The local component (for the region-averaged or world-averaged population within 100 km) and the regional component (for the region-averaged or world-averaged population between 100 km and 1,500 km) of the collective doses due to the atmospheric releases are presented separately, integrated to 100 years (first pass). Radon emissions from mill tailings produced per unit of electricity generated are assumed to continue for 100 years. The global components of collective doses resulting from the globally-circulating radionuclides ( $^3\text{H}$ ,  $^{14}\text{C}$ ,  $^{85}\text{Kr}$  and  $^{129}\text{I}$ ) are also shown, integrated to 100, 500 and 10,000 years. For ease of comparison, table 17 shows the final

aggregated values for the total collective dose to the world public and for the collective dose normalized to electricity generated for each of the processes mining and milling, power plant operation and reprocessing.

70. The results in tables 15 and 16 indicate that for discharges from both power plant operation and reprocessing facilities, the global component of the collective doses due to globally-circulating radionuclides integrated to 100 years and longer exceed the local and regional components of the collective doses due to the initial discharge (first pass) integrated out to 1,500 km. It is important to recognize that global components are summed over the population of the entire world, which is taken as  $10^{10}$  people to account for growth over the next 100 years (called “whole world population” in the tables 15 and 16). This component thus is the sum of a large number of very small doses with per caput values of the order of  $10^{-8}$  Sv, and per caput values normalized to electricity generated of the order of  $10^{-10}$  Sv/(GW a). Values for the collective doses in both tables 15 and 16 for the first-pass calculation are the doses integrated to 100 years and to a distance of 1,500 km for the local and regional components due to atmospheric discharges. Based on the results of the assessment, doses beyond this distance were assumed to be negligible.

71. For the nuclear industry, a significant fraction of the collective dose is due to radon discharges from mining and disposal of mill tailings. The importance of carbon-14 discharges from nuclear power plants and reprocessing is also evident. Table 18 shows the contribution from individual radionuclides to the collective doses to the public, and collective doses per unit of electricity generated, from reprocessing integrated to 100 years, not including contributions from globally-circulating radionuclides. Figure IV is derived from the data in table 18, showing collective doses per unit of electricity generated for individual radionuclides discharged from reprocessing. The importance of the carbon-14 contribution to dose is evident.

72. Figure V shows collective doses per unit of electricity generated due to the globally-circulating radionuclides (tritium,  $^{14}\text{C}$  and  $^{85}\text{Kr}$ ) integrated to 100, 500 and 10,000 years, for each reactor type considered. Besides indicating the variation in the dose contribution from globally-circulating radionuclides for the different reactor types, the graphs also illustrate the importance of  $^{14}\text{C}$ , whose contribution to collective dose increases with integration time. The global circulation for  $^{129}\text{I}$  is not included in figure V because it is only discharged during the reprocessing phase.

73. Figure VI compares the collective doses to the public from all discharges, atmospheric and aquatic, from all nuclear power plants by region and by reactor type, not including contributions from globally-circulating radionuclides. The data indicate that HWRs and PWRs are the reactor types that contribute most to the collective doses. Table 19 shows the total collective dose for all nuclear reactor types summed and by region, with North America and Europe showing the highest values.

Table 15. Summary of collective doses to the public due to mining and milling, electricity generation from nuclear power reactors, and fuel reprocessing (in 2010)

Discharge type and source	Collective dose <sup>a, b</sup> (man Sv)					
	Africa	Asia and Pacific	Europe	Latin America	North America	World
LOCAL COMPONENT – ATMOSPHERIC RELEASES						
Mining and milling	No data by region					$1.0 \times 10^1$
Power plants						
Inland	0	$1.2 \times 10^0$	$2.0 \times 10^0$	$1.7 \times 10^{-1}$	$2.2 \times 10^0$	$5.3 \times 10^0$
Coastal	$8.2 \times 10^{-3}$	$2.7 \times 10^0$	$1.2 \times 10^0$	$1.5 \times 10^{-2}$	$1.2 \times 10^{-1}$	$3.8 \times 10^0$
Reprocessing	—	—	$1.3 \times 10^0$	—	—	$2.1 \times 10^0$
REGIONAL COMPONENT – ATMOSPHERIC DISCHARGES						
Mining and milling	No data by region					$4.3 \times 10^1$
Power plants						
Inland	0	$3.0 \times 10^0$	$6.7 \times 10^0$	$1.3 \times 10^{-1}$	$5.8 \times 10^0$	$1.6 \times 10^1$
Coastal	$1.6 \times 10^{-3}$	$6.8 \times 10^0$	$3.5 \times 10^0$	$2.9 \times 10^{-2}$	$1.5 \times 10^{-1}$	$8.4 \times 10^0$
Reprocessing	—	—	$4.3 \times 10^0$	—	—	$4.4 \times 10^0$
LOCAL AND REGIONAL COMPONENT – AQUATIC DISCHARGES						
Mining and milling	No data by region					—
Power plants						
Inland	0	$1.4 \times 10^0$	$1.4 \times 10^1$	$8.1 \times 10^{-1}$	$1.8 \times 10^1$	$3.4 \times 10^1$
Coastal	$9.3 \times 10^{-5}$	$2.5 \times 10^{-2}$	$6.8 \times 10^{-2}$	$3.5 \times 10^{-4}$	$1.3 \times 10^{-3}$	$3.9 \times 10^{-1}$
Reprocessing	—	—	$2.6 \times 10^{-1}$	—	—	$1.1 \times 10^0$
LOCAL AND REGIONAL COMPONENTS (ATMOSPHERIC AND AQUATIC DISCHARGES)						
Mining and milling	No data by region					$5.3 \times 10^1$
Power plants	$9.9 \times 10^{-3}$	$1.5 \times 10^1$	$2.8 \times 10^1$	$1.2 \times 10^0$	$2.6 \times 10^1$	$6.8 \times 10^1$
Reprocessing	—	—	$5.8 \times 10^0$	—	—	$7.6 \times 10^0$
TOTAL LOCAL AND REGIONAL COMPONENTS <sup>c</sup>	$9.9 \times 10^{-3}$	$1.5 \times 10^1$	$3.3 \times 10^1$	$1.2 \times 10^0$	$2.6 \times 10^1$	$1.3 \times 10^2$

GLOBAL COMPONENT – GLOBALLY-DISPERSED RADIONUCLIDES	
<i>Source and integration time</i>	<i>Collective dose (man Sv)</i>
	<i>Whole world population</i>
Mining and milling integrated to	
100 years	—
500 years	—
10 000 years	—
Power plants integrated to	
100 years	$5.3 \times 10^2$
500 years	$1.0 \times 10^3$
10 000 years	$5.0 \times 10^3$
Reprocessing integrated to	
100 years	$2.6 \times 10^2$
500 years	$4.9 \times 10^2$
10 000 years	$2.4 \times 10^3$

<sup>a</sup> Local and regional components of the collective doses (due to the first pass) are integrated to 100 years. The local and regional components are explained in chapter III. Per caput values are not given in the table, but are discussed in the text.

<sup>b</sup> For all tables in the annex, the calculations resulting from assessments are made to full precision and any discrepancies in the final sum of numbers in the tables are due to rounding.

<sup>c</sup> Total of the local and regional components due to mining and milling, power plants and reprocessing from the first-pass. The totals for each region include only discharges from power plants, except for Europe, which also has a value for reprocessing.

Table 16. Summary of collective doses to the public due to mining and milling, electricity generation from nuclear power reactors, and fuel reprocessing (in 2010) normalized to electricity generated

Discharge type and source	Collective dose <sup>a</sup> per unit of electricity generated (man Sv/(GW a))					
	Africa	Asia and Pacific	Europe	Latin America	North America	World-average <sup>b</sup>
LOCAL COMPONENT – ATMOSPHERIC DISCHARGES						
Mining and milling	No data by region					4.1 × 10 <sup>-2</sup>
Power plants						
Inland	0	8.0 × 10 <sup>-1</sup>	2.2 × 10 <sup>-2</sup>	2.2 × 10 <sup>-1</sup>	2.5 × 10 <sup>-2</sup>	2.9 × 10 <sup>-2</sup>
Coastal	5.6 × 10 <sup>-3</sup>	4.3 × 10 <sup>-2</sup>	3.2 × 10 <sup>-2</sup>	6.8 × 10 <sup>-3</sup>	8.5 × 10 <sup>-3</sup>	3.3 × 10 <sup>-2</sup>
Reprocessing	—	—	1.2 × 10 <sup>-2</sup>	—	—	8.6 × 10 <sup>-3</sup>
REGIONAL COMPONENT – ATMOSPHERIC RELEASES						
Mining and milling	No data by region					1.7 × 10 <sup>-1</sup>
Power plants						
Inland	0	2.0 × 10 <sup>0</sup>	7.2 × 10 <sup>-2</sup>	1.7 × 10 <sup>-1</sup>	6.5 × 10 <sup>-2</sup>	8.9 × 10 <sup>-2</sup>
Coastal	1.1 × 10 <sup>-3</sup>	1.1 × 10 <sup>-1</sup>	9.4 × 10 <sup>-2</sup>	1.3 × 10 <sup>-2</sup>	1.1 × 10 <sup>-2</sup>	7.2 × 10 <sup>-2</sup>
Reprocessing	—	—	4.0 × 10 <sup>-2</sup>	—	—	1.8 × 10 <sup>-2</sup>
LOCAL AND REGIONAL COMPONENTS (AQUATIC DISCHARGES)						
Mining and milling	No data by region					—
Power plants						
Inland	0	9.3 × 10 <sup>-1</sup>	1.5 × 10 <sup>-1</sup>	1.1 × 10 <sup>0</sup>	2.0 × 10 <sup>-1</sup>	1.9 × 10 <sup>-1</sup>
Coastal	6.3 × 10 <sup>-5</sup>	4.1 × 10 <sup>-4</sup>	1.8 × 10 <sup>-3</sup>	1.6 × 10 <sup>-4</sup>	9.6 × 10 <sup>-5</sup>	3.3 × 10 <sup>-3</sup>
Reprocessing	—	—	3.0 × 10 <sup>-3</sup>	—	—	2.1 × 10 <sup>-3</sup>
LOCAL AND REGIONAL COMPONENTS (ATMOSPHERIC AND AQUATIC DISCHARGES)						
Mining and milling	No data by region					2.2 × 10 <sup>-1</sup>
Power plants	6.7 × 10 <sup>-3</sup>	2.4 × 10 <sup>-1</sup>	2.1 × 10 <sup>-1</sup>	3.9 × 10 <sup>-1</sup>	2.6 × 10 <sup>-1</sup>	2.3 × 10 <sup>-1</sup>
Reprocessing	—	—	5.5 × 10 <sup>-2</sup>	—	—	2.9 × 10 <sup>-2</sup>
TOTAL LOCAL AND REGIONAL COMPONENTS <sup>c</sup>	6.7 × 10 <sup>-3</sup>	2.4 × 10 <sup>-1</sup>	2.6 × 10 <sup>-1</sup>	3.9 × 10 <sup>-1</sup>	2.6 × 10 <sup>-1</sup>	4.3 × 10 <sup>-1</sup>



GLOBAL COMPONENT – GLOBALLY-DISPERSED RADIONUCLIDES	
<i>Source and integration time</i>	<i>Collective dose per unit of electricity generated (man Sv/(GW a))</i>
	<i>Whole world population</i>
Mining and milling integrated to	
100 years	—
500 years	—
10 000 years	—
Power plants integrated to	
100 years	$1.8 \times 10^0$
500 years	$3.4 \times 10^0$
10 000 years	$1.7 \times 10^1$
Reprocessing integrated to <sup>d</sup>	
100 years	$1.2 \times 10^0$
500 years	$2.1 \times 10^0$
10 000 years	$1.0 \times 10^1$

<sup>a</sup> Local and regional components of the collective doses (due to the first pass) are integrated to 100 years. The local and regional components are explained in chapter III. Per caput values are not given in the table, but are discussed in the text.

<sup>b</sup> World-average is used to qualify the calculations and data that are intended to represent a value averaged across the whole world. In this case the world average is the average of the population in each annulus for all nuclear sites for which data are available (annex A). Similarly, consumption rates for terrestrial and aquatic foods are average values for the world population. The world-average values can be used for comparative purposes including for comparison with the previous versions of the methodology for estimating public exposures due to radioactive discharges (annex A).

<sup>c</sup> Total of the local and regional components due to mining and milling, power plants and reprocessing from the first-pass. The totals for each region include only discharges from power plants, except for Europe, which also has a value for reprocessing.

<sup>d</sup> The normalized values were calculated as described in paragraphs 65 and 66.

Table 17. Comparison of the worldwide collective dose, and associated collective dose normalized to electricity generated, from mining and milling, power plant operation and reprocessing

<i>Nuclear fuel cycle</i>	<i>Collective dose (man Sv)</i>	<i>Normalized collective dose<sup>a</sup> (man Sv/(GW a))</i>
Local and regional component from mining and milling, power plants and reprocessing (first pass) <sup>b</sup>	130	0.43
Local and regional component (integrated to 100 years) plus global component integrated to		
100 years	910	3.0
500 years	1 700	5.5
10 000 years	7 600	25

<sup>a</sup> These values are averages for the whole world. The world average is the average of the population in each annulus for all nuclear sites for which data are available (annex A). Similarly, consumption rates for terrestrial and aquatic foods were average values for the world population. The results can be used for comparative purposes including for comparison with the previous versions of the methodology for estimating public exposures due to radioactive discharges (annex A).

<sup>b</sup> Local and regional components of the collective doses (due to the first pass) are integrated to 100 years. The local and regional components are explained in chapter III.

Table 18. Radionuclide contributions to the local and regional components of collective doses to the public from reprocessing integrated to 100 years

<i>Radionuclide</i>	<i>Collective dose per unit of electricity generated (man Sv/(GW a))</i>			<i>Collective dose (man Sv)</i>		
	<i>Atmosphere</i>	<i>Aquatic</i>	<i>Total</i>	<i>Atmosphere</i>	<i>Aquatic</i>	<i>Total</i>
<sup>3</sup> H	$1.3 \times 10^{-3}$	$3.6 \times 10^{-6}$	$1.3 \times 10^{-3}$	$7.1 \times 10^{-1}$	$8.0 \times 10^{-4}$	$7.1 \times 10^{-1}$
<sup>14</sup> C	$2.0 \times 10^{-2}$	$1.7 \times 10^{-3}$	$2.2 \times 10^{-2}$	$4.0 \times 10^0$	$5.4 \times 10^{-1}$	$4.5 \times 10^0$
<sup>41</sup> Ar	0	0	0	$1.7 \times 10^{-3}$	0	$1.7 \times 10^{-3}$
<sup>54</sup> Mn	0	$8.4 \times 10^{-7}$	$8.4 \times 10^{-7}$	0	$1.7 \times 10^{-4}$	$1.7 \times 10^{-4}$
<sup>58</sup> Co	0	$1.8 \times 10^{-8}$	$1.8 \times 10^{-8}$	0	$3.6 \times 10^{-6}$	$3.6 \times 10^{-6}$
<sup>60</sup> Co	$3.4 \times 10^{-7}$	$6.1 \times 10^{-5}$	$6.1 \times 10^{-5}$	$1.6 \times 10^{-4}$	$3.0 \times 10^{-2}$	$3.0 \times 10^{-2}$
<sup>85</sup> Kr	$4.5 \times 10^{-3}$	0	$4.5 \times 10^{-3}$	$1.1 \times 10^0$	0	$1.1 \times 10^0$
<sup>90</sup> Sr	0	$5.8 \times 10^{-7}$	$5.8 \times 10^{-7}$	$3.0 \times 10^{-2}$	$9.8 \times 10^{-4}$	$3.1 \times 10^{-2}$
<sup>106</sup> Ru	$4.2 \times 10^{-7}$	$9.0 \times 10^{-5}$	$9.0 \times 10^{-5}$	$1.2 \times 10^{-3}$	$2.8 \times 10^{-2}$	$2.9 \times 10^{-2}$
<sup>129</sup> I	$8.3 \times 10^{-4}$	$2.3 \times 10^{-5}$	$8.5 \times 10^{-4}$	$5.1 \times 10^{-1}$	$5.3 \times 10^{-3}$	$5.2 \times 10^{-1}$
<sup>131</sup> I	$9.6 \times 10^{-7}$	$1.3 \times 10^{-9}$	$9.6 \times 10^{-7}$	$1.1 \times 10^{-3}$	$2.6 \times 10^{-7}$	$1.1 \times 10^{-3}$
<sup>135</sup> Xe	0	0	0	$3.6 \times 10^{-4}$	0	$3.6 \times 10^{-4}$
<sup>134</sup> Cs	$2.0 \times 10^{-7}$	$1.7 \times 10^{-6}$	$1.9 \times 10^{-6}$	$3.9 \times 10^{-5}$	$8.1 \times 10^{-4}$	$8.5 \times 10^{-4}$
<sup>137</sup> Cs	$1.9 \times 10^{-7}$	$1.7 \times 10^{-5}$	$1.7 \times 10^{-5}$	$6.5 \times 10^{-3}$	$1.8 \times 10^{-2}$	$2.5 \times 10^{-2}$
<sup>239</sup> Pu	$3.7 \times 10^{-6}$	$8.3 \times 10^{-5}$	$8.7 \times 10^{-5}$	$1.6 \times 10^{-1}$	$2.5 \times 10^{-1}$	$4.2 \times 10^{-1}$
<sup>241</sup> Am	0	$5.7 \times 10^{-5}$	$5.7 \times 10^{-5}$	$1.2 \times 10^{-2}$	$2.0 \times 10^{-1}$	$2.2 \times 10^{-1}$
Total	$2.7 \times 10^{-2}$	$2.1 \times 10^{-3}$	$2.9 \times 10^{-2}$	$6.5 \times 10^0$	$1.1 \times 10^0$	$7.6 \times 10^0$

Table 19. Local and regional components of collective dose integrated to 100 years summed over all reactor types

	<i>Africa</i>	<i>Asia and Pacific</i>	<i>Europe</i>	<i>Latin America</i>	<i>North America</i>	<i>World</i>
Collective dose (man Sv)	$9.9 \times 10^{-3}$	$1.5 \times 10^1$	$2.8 \times 10^1$	$1.2 \times 10^0$	$2.6 \times 10^1$	$6.8 \times 10^1$

Figure IV. Contribution of radionuclides to the local and regional components of collective dose to the public from reprocessing integrated to 100 years and normalized to electricity generation

See data in table 18

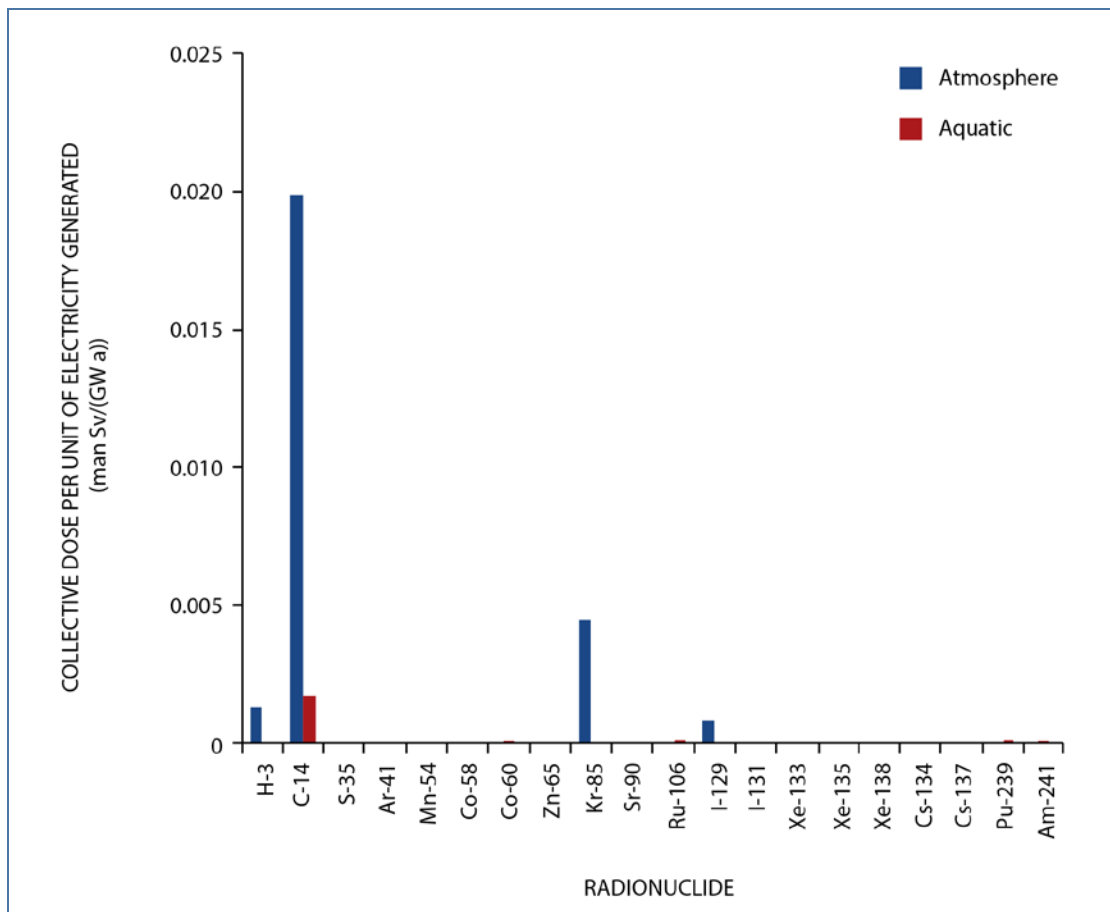

Figure V. Collective doses from globally-circulating radionuclides per unit of electricity generated

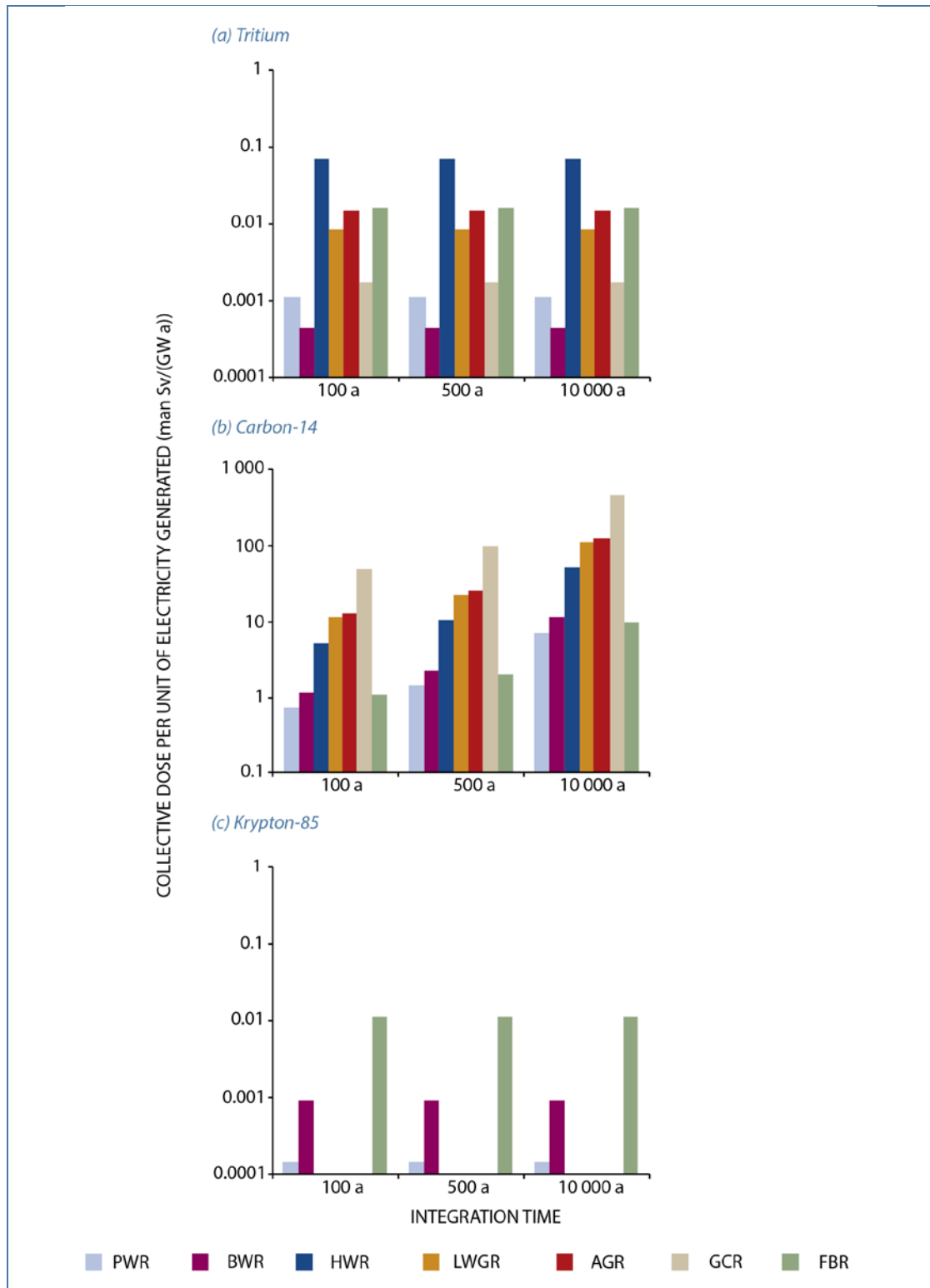
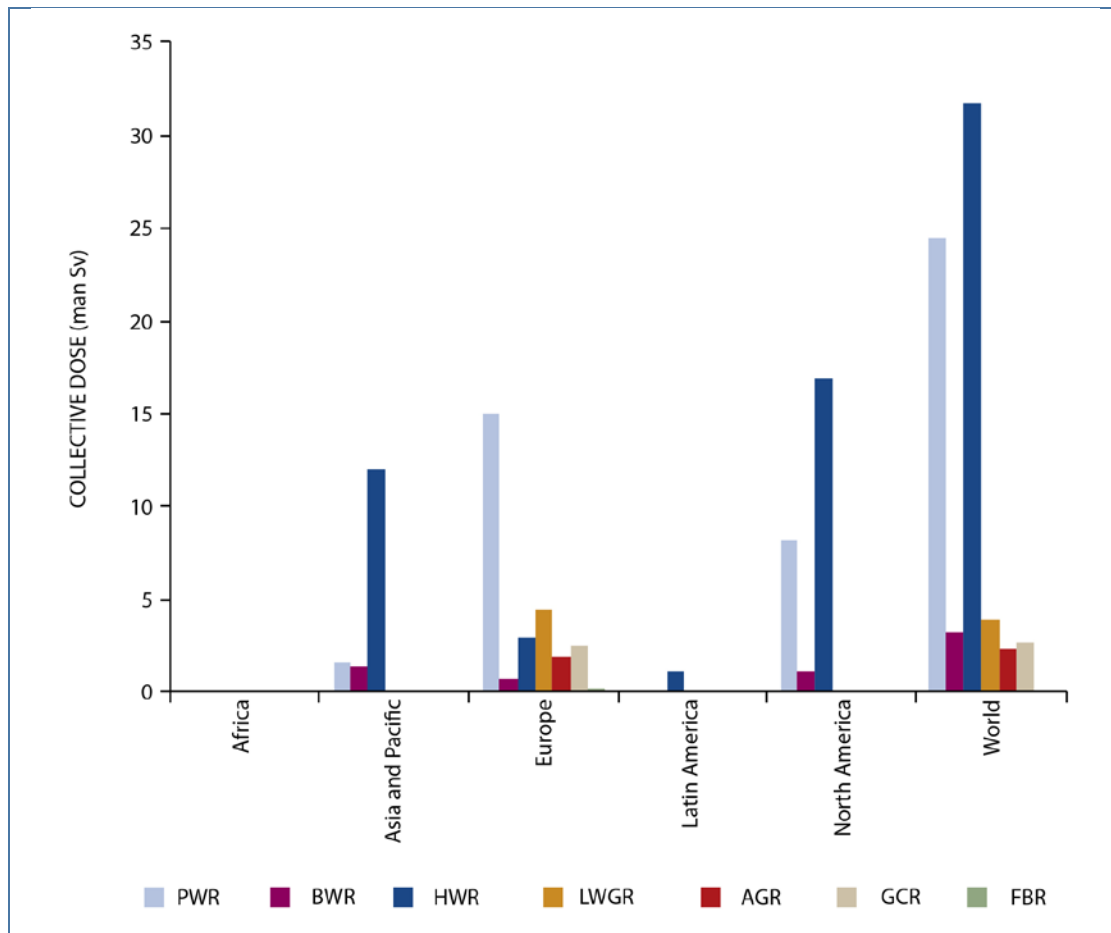

Figure VI. Local and regional components of the collective doses to the public due to total estimated discharges from nuclear power plants (2010) integrated to 100 years, by UNEP region and by reactor type



#### 4. Uranium enrichment and fuel fabrication

74. The discharges from the processes of conversion, uranium enrichment and subsequent fuel fabrication needed for different reactor types have generally been determined in earlier studies to be relatively small, consisting mainly of radionuclides within the decay chains of uranium isotopes. The collective dose to the public estimated on the basis of the electricity generated, derived in the UNSCEAR 2000 Report [U9] and re-used in the UNSCEAR 2008 Report [U11], were used here to obtain an updated value based on the 2010 electricity generation from nuclear power. This value for uranium enrichment and fuel fabrication facilities is 0.003 man Sv/(GW a). The Committee earlier estimated the average annual collective dose to the public from all plants for the period 1998–2002 to be 0.8 man Sv [U11]. Updating this value to the electricity generated from nuclear power in 2010 from table 2, the average annual collective dose to the public due to uranium enrichment and fuel fabrication in the year 2010 is about 0.9 man Sv.

## 5. Solid waste disposal

75. Solid wastes arise at various stages in the nuclear fuel cycle. These include low- and intermediate-level wastes, mainly from reactor operations, high-level wastes from fuel reprocessing, and spent fuel for direct disposal. The activity concentrations of these wastes can range from just above natural background levels, as in mill tailings, to much higher levels, such as in spent reactor fuel.

76. Low- and intermediate-level wastes are generally disposed of by shallow burial in trenches or concrete-lined structures, but more advanced disposal sites also exist. Before disposal, all such material is manipulated and transported, which gives rise to both occupational and public exposures. For the nuclear fuel cycle, doses to members of the public from the transport of radioactive material have been earlier estimated using the factor of 0.1 man Sv/(GW a) for the collective dose per unit of electricity generated [U11]. Wastes from the nuclear fuel cycle also include large quantities of depleted uranium from uranium enrichment operations [U18]. High-level wastes and spent fuel are presently retained in interim storage facilities until adequate methods for disposal have been devised and disposal sites selected [U11].

77. Estimates of the doses due to solid waste disposal have been based on the projected eventual migration of radionuclides from the burial site into groundwater. The collective dose due to low- and intermediate-level waste disposal normalized to electricity generated is estimated to be approximately 0.5 man Sv/(GW a), due almost entirely to <sup>14</sup>C. The average worldwide per caput annual effective dose would be about 1 nSv per year of practice [U11].

## C. Occupational exposure for the nuclear fuel cycle

78. The assessment of occupational exposures for the nuclear fuel cycle considers the practices of mining, milling, uranium enrichment and conversion, fuel fabrication, reactor operation, fuel reprocessing and research.

79. Collective doses due to occupational exposure for each practice in the nuclear fuel cycle that were reported in the UNSCEAR 2008 Report [U11] for the years 2000–2002 were used as the starting point to estimate the 2010 occupational exposures. This approach was taken since data were not readily available on the total number of, or the average annual effective dose to, monitored workers worldwide in 2010. As reported in the UNSCEAR 2008 Report, the Committee used the amount of electricity that can be generated from each practice (i.e. how much electricity can be generated from the uranium that is mined, milled, converted, and so on) to normalize collective doses to the electricity generated.

80. Table 20 summarizes the data on occupational exposure for the nuclear fuel cycle in the period 2000–2002 that are relevant for estimating occupational exposure for the nuclear fuel cycle in 2010.

81. The ratio from the 2000–2002 data for the average annual collective dose per unit of electricity generated was combined with the electricity generation for 2010 to estimate the annual collective dose for 2010. Similarly, the ratio obtained from 2002 for the average annual collective dose per unit mass of uranium mined, which can be further transformed to the collective dose per unit of electricity generated is assumed appropriate for the mining process. Actual data from the Canada, the United Kingdom and the United States for 2010 were obtained on the number of monitored workers and their average annual effective dose, and were compared with the respective country values for 2000–2002 in the UNSCEAR 2008 Report [U11]. These comparisons showed reasonable agreement with the scaled average annual effective dose, giving some confidence in the assumptions used.

Table 20. Worldwide average annual individual and collective doses to workers due to the commercial nuclear fuel cycle

From table 72 in the UNSCEAR 2008 Report [U11]; for the years 2000–2002<sup>a</sup>

Practice	Monitored workers (thousands)	Average annual <sup>b</sup> collective dose (man Sv)	Average annual <sup>b</sup> collective dose per unit of electricity generated (man Sv/(GW a))	Average annual <sup>b</sup> effective dose to monitored workers (mSv)
Mining	12	22	0.1	1.8
Milling	3	3	0.02	1.0
Enrichment	18	2	0.02	0.1
Fuel fabrication	20	31	0.1	1.6
Reactor operation	437	617	2.5	1.4
Reprocessing <sup>c,d</sup>	76	68		0.9
Research	90	36	0.1	0.4
Total	656	779	2.8	1.2

<sup>a</sup> Some values in the table have been corrected since table 72 was published in the UNSCEAR 2008 Report [U11]; for the years 2000–2002.

<sup>b</sup> The words “average annual” used in the table denote the annual dose averaged over the 2000–2002 year span.

<sup>c</sup> Also includes the reprocessing of some fuel associated with military application.

<sup>d</sup> The average annual collective dose per unit of electricity generated was not possible to obtain, because there were no data readily available on the amount of electricity generated from the reprocessed fuel.

82. Table 21 shows the current results for 2010 for the worldwide average annual collective dose compared to the 2000–2002 results. The procedure for estimating the values for each practice for 2010 is explained below.

- *Uranium mining.* The amount of uranium ore mined was assumed equal to the amount produced [U11]. Total uranium production in 2010 for 16 countries is shown in table 4 [O8]. Values were summed for all countries to give 54,100 t of uranium. Of this amount, 31,900 t was produced from open pit and underground uranium mines and 22,200 t was produced from in-situ leaching (ISL) processes. Assuming the same collective dose per unit mass of uranium extracted of 0.623 man Sv/kt as for 2000–2002 [U11], then the collective dose (rounded) is 20 man Sv. This value excludes uranium produced from ISL.
- *Uranium milling.* As for uranium mining, the total uranium production in 2010 was taken from table 4 [O8] and assumed to equal the total amount of uranium milled, 54,104 t. Applying the same simplifying assumptions used in the UNSCEAR 2008 Report [U11] (i.e. that all milled uranium is used in LWRs and that the uranium requirement is 220 t/(GW a) ([U11]; table 18-A)), the equivalent amount of electricity for 2010 is 246 GW a. The collective dose (rounded) for 2010 is then 5 man Sv. While ISL extract is not milled, it does go through some treatment to produce yellowcake. Thus the full amount of uranium mined, 54,100 t, is used here.
- *Uranium conversion and enrichment, and fuel fabrication.* UNSCEAR 2008 Report (table 15) shows the worldwide installed capacity for fuel cycle installations taken from the IAEA Nuclear Fuel Cycle Information System, NFCIS. Compiling the data from NFCIS for 2010 and comparing with table 15 from the UNSCEAR 2008 Report shows little has changed in the

capacity of these processes. All three processes show decreased capacities of between 8% and 9%. Using the assumption that these practices give the same collective dose per unit of electricity generated in 2010 as in 2002, the average annual collective dose for 2010 in table 21 has been adjusted to a lower value by 8%.

- *Reactor operation.* The normalized average annual collective dose for 2000–2002 was 2.5 man Sv/(GW a). Instead of using this value directly, as explained above, data from the OECD/NEA [O4] indicated a general decrease in the average annual collective doses. The reported average annual collective dose for operating nuclear power plants fell by 20% between 2002 and 2010, attributed to additional operating experience and the global exchange of best radiation protection practices. Using this, the normalized average annual collective dose for 2010 can be taken as 2.0 man Sv/(GW a). Assuming the total worldwide electricity generation in 2010 is 314 GW a, an average annual collective dose of 628 man Sv was calculated, about the same as that reported for 2002, as shown in table 21.
- *Reprocessing.* In the absence of updated data on occupational exposures during fuel reprocessing in 2010, it was assumed that reprocessing activities have remained more or less constant and the same collective dose was assigned as previously, i.e. no change. Data from UNSCEAR [U11] were not presented in terms of dose per unit of electricity generated.
- *Research.* In the absence of updated data on occupational exposures obtained during research for 2010, it was assumed that research activities have remained more or less constant and the same collective dose was assigned as previously. However, it should be noted that a slight downward trend in collective dose was observed over the previous two time periods in UNSCEAR [U11]. Data from UNSCEAR [U11] were not presented in terms of dose per unit of electricity generated.



Table 21. Worldwide levels of exposure of workers due to the commercial nuclear fuel cycle for 2010 and 2000–2002

<i>Practice</i>	<i>Average annual collective effective dose 2000–2002 (man Sv) (From [U11] for years 2000–2002)</i>	<i>Average annual collective dose 2010 (man Sv) (Estimates from this study)</i>	<i>Average annual collective dose per unit of electricity generated (man Sv/(GW a)) (From [U11] for years 2000–2002)</i>	<i>Remarks</i>
Mining	22	20	0.1	U production 2010=54.1 kt; of this 31.9 kt was the amount of U produced excluding ISL production (35 ktU average in 1998–2003)
Milling	3	5	0.02	246 GW a calculated using same simplifying assumption from UNSCEAR 2008 Report, table 18-A, that all milled uranium was used in LWRs, and that uranium requirement was 220 t/(GW a). Doses resulting from subsequent remediation activities were not accounted for
Enrichment	2	2	0.02	8% lower capacity than in 2000–2002 (not noticeable because numbers are rounded)
Fuel fabrication	31	29	0.1	8% lower throughput than in 2000–2002
Reactor operation	617	628	2.5	314 GW a total electricity generated by nuclear power plants in 2010 [I15, I16]
Reprocessing	68	68		Assumed constant collective dose–i.e. no change. Data were not presented [U11] in terms of dose per unit of electricity generated
Research	36	36	0.1	Assume constant collective dose–i.e. no change
Total	779	788	2.8	

## D. Decommissioning

83. When a power company decides to close a nuclear power plant permanently, the facility must be decommissioned by safely removing it from service and reducing residual radioactivity to a level that permits release of the property and termination of the operating licence. As more commercial nuclear power reactors reach the end of their operating licence, there is a commensurate increase in decontamination and decommissioning activities that involve radiation exposure. These activities include decontamination of structures and components, dismantling of components and demolition of buildings, remediation of any contaminated ground, and removal of the resulting waste. As of 2015, 156 commercial and prototype reactors located in 19 countries with a total of 60.9 GW(e) capacity were permanently shut down [I8]. Most of these reactors were PWRs, GCRs and BWRs. The current assessment concentrated on occupational exposures during the decommissioning process.

84. The decommissioning process begins when a power company decides to permanently cease operations. The operator of a nuclear facility may choose between three decommissioning strategies: (a) immediate dismantling, (b) deferred dismantling after a safe storage period, and (c) entombment of the facility. Under immediate dismantling, decommissioning activities begin shortly after the permanent cessation of operations. This strategy implies prompt completion of the decommissioning project (approximately 10 to 20 years) and involves the removal of all radioactive material from the facility to another new or existing licenced facility.

85. Under deferred dismantling (sometimes called safe storage, safe store or safe enclosure), a nuclear facility is maintained and monitored in a condition that allows the radioactivity to decay and thus reduce occupational exposure. Parts of a facility containing radioactive contaminants are safely stored and maintained for upwards of 40 to 60 years until they can subsequently be decontaminated to levels that permit parts of the facility to be dismantled and released for unrestricted use.

86. Under entombment, radioactive contaminants are encased in a structurally long-lived material such as concrete until radioactivity decays to a level permitting the unrestricted release of the facility, or release with restrictions imposed by the regulatory body.

87. As of December 2015, the International Atomic Energy Agency/Nuclear Energy Agency Information System on Occupational Exposure (ISOE) database (<http://www.isoe-network.net/>) contained data on doses to workers from 84 reactors that were shut down, in some stage of decommissioning or fully decommissioned. These reactor units were generally of different types and sizes, and at different phases of their decommissioning programmes. At least 15 reactors had been fully dismantled, over 50 reactors were being dismantled, over 50 reactors were in deferred dismantlement, three had been entombed, and for others the decommissioning strategy was not specified yet.

88. Table 22 provides the average annual collective dose for occupational exposure per unit for up to 71 permanently shut down reactors by country and reactor type for 2008–2013, based on data recorded in the ISOE database and supplemented by individual country reports. Different decontamination and decommissioning strategies were being employed and each facility shown in the database was in a different stage of decommissioning, making definitive trends difficult to deduce from this information. Depending on the phase of decommissioning, there may be little or no worker exposure one year and the next year collective dose to workers may rise as much as 100-fold (adapted from [O5]). Considering the average collective doses for each of the reactor types, however, and the total average for all the units, the average values demonstrate some stability over these six years, with the total average for all units being about 0.06 man Sv per year and reactor.

89. Table 23 shows data from the whole decommissioning period for nuclear power plants that have been immediately decontaminated and decommissioned. The dose values given are the integrated doses for the whole decommissioning process. There may be some additional dose due to spent fuel storage until a permanent repository is opened, but these occupational exposures can be considered negligible compared to active decommissioning. For example, for five of the decommissioned units that reported to the REIRS database (Radiation Exposure and Information Reporting Systems) ([U24]; table 3.1), collective doses from occupational exposure due to spent fuel storage ranged from 0 to  $1.86 \times 10^{-3}$  man Sv annually. The values for electricity supplied were the total integrated electricity generation from the time the unit went on the grid until it ceased operation.

90. The relative quantity needed for the comparative study conducted here was an estimate of the collective doses from occupational exposure for decommissioning, integrated over the period of decommissioning. The fact that the annual collective dose varies from year to year is not relevant if a reasonable average can be obtained. Although limited, the Committee considered that the data on integrated doses for nuclear reactors shown in table 23 were sufficient for its use here.

91. The average total collective dose associated with the strategy of immediate decontamination and decommissioning of the commercial nuclear power plants shown in table 23 was less than 10 man Sv per reactor. While the alternative decommissioning strategies, deferred dismantling and entombment, may result in some reduction in the total collective dose per reactor from decommissioning, it may be another 10 to 20 years before any definitive conclusions can be documented.

92. Table 23 also shows the collective dose from occupational exposure normalized to the total integrated electricity supplied for each of the reactors, with an average for these 8 reactors of 1.80 man Sv/(GW a).

Table 22. Number of units and average annual collective dose from occupational exposure per reactor by country and reactor type for definitely shutdown reactors, 2008–2013

The columns headed dose give the average annual collective dose from occupational exposure in man-millisieverts per reactor (man mSv)

		2008		2009		2010		2011		2012		2013	
		No.	Dose	No.	Dose	No.	Dose	No.	Dose	No.	Dose	No.	Dose
PWR	France	1	23.2	1	62.1	1	117.2	1	264.1	1	275.6	1	189.3
	Germany	5	160.0	5	128.0	3	278.6	3	126.3	3	114.4	4	77.7
	Italy	1	1.1	1	1.7	1	3.2	1	1.8	1	3	1	5.2
	Spain	1	134.7	1	244.0	1	53.0	1	190.0	1	307.9	1	468.9
	United States	10	7.1	8	1.5	8	2.4	6	49.4	6	127.1	12	47.3
	Average	18	57.2	16	60.0	14	73.5	12	94.4	12	141	19	81.1
VVER	Bulgaria	4	31.0	4	29.4	4	11.3	4	9.2	4	10.1	4	3.3
	Germany	5	27.0	5	20.0	—	—	—	—	—	—	—	—
	Russian Federation	2	78.0	2	84.0	2	77.6	2	66.3	2	79.2	2	49.6
	Slovak Republic	1	48.2	2	106.0	2	12.4	2	10.0	2	4.3	—	—
	Average	12	38.6	13	46.0	8	28.2	8	23.7	8	25.9	6	18.7
BWR	Germany	3	179.0	3	138.0	1	427.1	1	289.5	1	88.2	1	72.0
	Italy	2	29.1	2	61.8	2	60.3	2	15.1	2	18.4	2	34.2
	Japan	—	—	—	—	2	123.8	2	48.4	2	41.2	2	64.2
	The Netherlands	1	0.3	1	0.6	n/a	n/a	1	10	—	—	—	—
	Sweden	2	39.1	2	27.0	2	6.2	2	27.2	2	20	2	3.45
	United States	3	13.4	4	5.1	5	21.8	4	30.7	4	59.4	5	55.7
	Average	11	64.9	12	51.1	12	76.3	12	50.3	11	44.1	12	46.2

		2008		2009		2010		2011		2012		2013	
		No.	Dose	No.	Dose	No.	Dose	No.	Dose	No.	Dose	No.	Dose
GCR	France	6	2.8	6	8.8	6	1.3	6	2.4	6	7.4	6	8.2
	Germany	2	13.0	2	17.0	—	—	—	—	—	—	—	—
	Italy	1	2.9	1	0	1	1.7	1	10.4	1	0.2	1	2.2
	Japan	1	20.0	1	20.0	1	50	1	50	1	70	1	10
	Spain	—	—	—	—	—	—	1	0	1	0	1	0
	United Kingdom	16	48.0	16	42.0	16	55	16	49	19	56	19	57.3
	United States	—	—	—	—	—	—	—	—	1	0	1	0
	Total number, average dose	26	32.1	26	30.0	24	39.1	25	34.4	28	42.1	28	41.1
HTGR	Germany	1	0	1	0	1	0	1	0	—	—	1	0
FBR	United States	—	—	1	80.14	1	77.9	1	294.9	1	2	1	0.1
LWGR	Lithuania	1	188.4	1	144.7	2	236.2	2	304.8	2	264.9	2	304.8
LWCHWR	Japan	1	431.3	1	114.6	1	111.6	1	126.6	1	148.8	1	134.1
All Units	Average	70	52.3	71	47.7	63	59.9	62	61.5	64	66.3	71	57.8

This table is adapted from table 4 in the 2012 IAEA annual report [O5] and table 5 from the 2010 IAEA annual report [O4]. Additional information was obtained from the individual country reports and the IAEA database, and the United States Nuclear Regulatory Commission Radiation Exposure and Information Reporting System (REIRS) [U24] database for United States definitely shut reactors. Data for 2013 were obtained from the 2013 IAEA country reports [O7] and the IAEA database [I20].

Dashes (—) represent missing or partial data in the data source. The acronyms for the reactor type used in tables 22 and 23 differ somewhat from those in the other tables in this annex (see paragraph 58). The acronyms in this table and table 23 are the designations used by the Nuclear Energy Agency.

The following explains the meaning of the acronyms that differ from previous tables:

LWCHWR (Light Water Cooled Heavy Water Reactor) also known as a CANDU reactor is the Canadian designed system. IAEA would refer to this as a PHWR.

VVER (water, water, energetic reactor) is a Soviet designed PWR.

HTGR, (also called HTGC, high temperature gas cooled) reactor. More of a prototype reactor but nuclear power plants include Peach Bottom and Fort Saint Vrain in the United States; Dragon reactor in the United Kingdom, and THTR-300 and AVR in Germany.

Table 23. Collective dose, and collective dose normalized to electricity supplied, due to the complete decommissioning process of immediately decontaminated and decommissioned commercial nuclear power plants

Reactor gross electrical capacity and total electricity supplied were obtained from the IAEA PRIS database [I7]. Collective doses were obtained from the ISOE database [I20] and REIRS reports [U24]

<i>Reactor type</i>	<i>Country</i>	<i>Plant</i>	<i>Gross Capacity (MW(e))</i>	<i>Collective dose (man Sv)</i>	<i>Electricity supplied (GW a)</i>	<i>Normalized collective dose (man Sv/GW a)</i>
PWR	United States	Haddem Neck	603	8.457	12.1	0.70
		Maine Yankee	900	6.195	13.6	0.46
		Rancho Seco	917	2.345	5.1	0.46
		San Onofre 1	456	3.002	5.8	0.52
		Trojan	1 155	2.973	9.6	0.31
		Yankee Rowe	180	6.467	3.9	1.66
		AVERAGE		4.907	8.34	0.69
BWR	United States	Big Rock Point	71	5.703	1.45	3.93
HTGR	United States	Fort St. Vrain	342	3.961	0.62	6.39
All units	Average			4.900		1.80

## V. RADIATION EXPOSURES ARISING FROM ELECTRICITY GENERATION BY COMBUSTION OF FOSSIL FUELS

### A. Coal

#### 1. Introduction

93. Coal is a family name for a variety of solid organic fuels and refers to a whole range of combustible sedimentary rock materials spanning a continuous quality scale. For convenience, this continuous series is often divided into two main categories: hard coal (which includes anthracite and bituminous coal) and brown coal (which includes sub-bituminous coal and lignite). The International Energy Agency [I15] makes use of two broad categories of coal; hard coal as having a gross calorific value not less than 23.9 GJ/t (5,700 kcal/kg) and brown coal with a gross calorific value less than 23.9 GJ/t (5,700 kcal/kg). Often coal data are presented in tonnes of coal equivalent (TCE) where one tonne of coal is equivalent to 7 million kilocalories. This description standardizes the carbon content and heat value of a particular type of coal. The International Energy Agency estimates that there are equal recoverable global reserves of both hard coal and brown coal [I14].

94. Combustion of coal for electricity generation is the largest contributor to worldwide electricity generation (figure I). Coal has maintained a share of about 40% of the total electricity generated for some decades, while the total electricity generation from coal and other sources has increased steadily as shown in figure I [I15]. The UNEP geographic region—Asia and the Pacific—accounted for 57% of the total electricity generation from coal in 2010, with China accounting for about 70% of this [U17]. In contrast, the geographic region—West Asia—used no coal for electricity generation in 2010 (table 2).

95. Electricity generation is not the only end-product of coal combustion, others being for example steel production and cement manufacturing. The largest 10 coal-producing countries are shown for the years 2008–2012 in table 24. China was the largest producer with a 30% increase in production over this five-year period. The total world primary coal production for this period had a 16% increased production in 2012 compared with 2008, and about a 60% increased production during the 10-year period since 2002 [U17].

96. Coal contains naturally occurring radionuclides from the uranium and thorium series (figure III) and potassium-40. The concentration of naturally occurring radioactive material in coal depends on the characteristics of the geological formation of the coal seams where it originated. Table 25 provides a representative overview of the range in concentrations, where large variations in the activity concentrations can be noted.

Table 24. Total primary coal production 2008–2012 (million metric tonnes, Mt)

Source: United States Energy Information Administration, International Energy Statistics 2008–2012, open source data [U17]

Country	2008	2009	2010	2011	2012
China	2 811	2 995	3 230	3 518	3 645
United States	1 063	975	984	994	922
India	517	558	562	575	589
Australia	392	408	424	402	421
Russian Federation	305	276	322	322	354
South Africa	252	249	255	253	259
Indonesia	249	291	325	360	443
Poland	143	135	133	139	144
Kazakhstan	111	101	111	116	126
Colombia	74	73	74	86	89
World	6 778	6 896	7 257	7 660	7 881

Table 25. Example ranges and/or averages of radionuclide activity concentrations in coal (Bq/kg) (table VII from IAEA [I2])

Country	$^{238}\text{U}$	$^{230}\text{Th}$	$^{226}\text{Ra}$	$^{210}\text{Pb}$	$^{210}\text{Po}$	$^{232}\text{Th}$	$^{228}\text{Ra}$	$^{40}\text{K}$
Australia	8.5–47	21–68	19–24	20–33	16–28	11–69	11–64	23–140
Brazil <sup>a</sup>	72		72	72		62	62	
Egypt	59		26			8	8	
Germany Lignite (Former Democratic Republic of Germany)			10–145 32 <sup>a</sup> <1–58 10 <sup>a</sup>			10–63 21 <sup>a</sup> <1–58 8 <sup>a</sup>		10–700 225 <sup>a</sup> <4–220 22 <sup>a</sup>
Greece <sup>b</sup>	117–390		44–206	59–205			9–41	
Hungary	20–480					12–97		30–384
Italy <sup>c</sup>	23±3					18±4		218±15
Poland	<159 18 <sup>d</sup>					<123 11 <sup>d</sup>		<785
Romania	<415 80 <sup>a</sup>		<557 126 <sup>a</sup>	<510 210 <sup>a</sup>	<580 262 <sup>a</sup>	<170 62 <sup>a</sup>		
United Kingdom	7–19	8.5–25.5	7.8–21.8			7–19		55–314
United States	6.3–73		8.9–59.2	12.2–77.7	3.3–51.8	3.7–21.1		

<sup>a</sup> Average.

<sup>b</sup> Lignite.

<sup>c</sup> Lignite, average.

<sup>d</sup> Average for all coal seams.

97. When coal is combusted the majority of the non-combustible matter remains in the bottom and fly ash. Because radionuclides are present in the mineral constituents, they also tend to remain in the ash, where the concentration of the radionuclides becomes enhanced [I2, S4, Z1]. However, radon is a noble gas and all the radon present in the coal is emitted through the flue-gas stack. As coal-fired power plants have modernized, the cleaning and filtering systems have become increasingly efficient and larger fractions of the particulate matter in the fly ash have been captured and removed from the discharge to atmosphere. The coal ash that is collected is either recycled for beneficial use or it is disposed of in landfills or impoundments.<sup>6</sup>

98. The components of the coal cycle that can lead to radiation exposures of the public are (a) discharges to atmosphere of radon from coal-mining activities and other wastes produced during mining, (b) radioactive discharges from the operation of coal-fired power plants, and (c) radiation exposures from the recycling and use of, or disposal of, coal ash. Occupational radiation exposures

<sup>6</sup> Coal ash can be disposed as a coal slurry in impoundments, a dammed reservoir that contains the coal slurry.



occur during (a) the mining for coal, and (b) work performed associated with power plant operation and disposal operations. In earlier studies, occupational exposures from work performed at the power plant were determined to be small [C5, G4, G5] in relation to the occupational radiation exposures incurred during coal mining. For this reason, combined with the relatively small number of workers involved compared to coal mining, this exposure source was not considered further in the current study. The following sections consider the other exposure sources and pathways.

## 2. Public exposure

### (a) Coal mining

99. Radon emissions from coal mining contribute to exposure of the public from the coal cycle. Radon gas is emitted from the mines as a result of the coal mining activities, primarily through venting of the mines. Although data that could enable the assessment of this impact have earlier been scarce, new measurements on radon emissions from coal mining in China have become available. Radon emissions from 23 large-, medium- and small-sized coal mines in eight different provinces in China have been assessed, based on the monitoring results of radon activity in the mines. The large- and medium-sized coal mines are equipped with ventilation systems that are described as “good” or “relatively good.” The smaller, privately owned coal mines generally are poorly ventilated, with radon concentrations 15 to 30 times higher than in the larger mines [L1]. The radon emissions have been normalized to the unit of coal output and per unit of electricity generated for each coal mine and for each size-class of coal mine. Typical values were obtained as shown in table 26 [W2].

Table 26. Radon emissions during one year from large-, medium- and small-sized coal mines in China [W2]

Type of coal mine	Coal output (t/a)	Number of coal mines	Radon emissions per unit of coal output (Bq/t)	Radon emissions per unit of electricity generated (TBq/(GW a)) <sup>a</sup>
Large-sized	$1.6 \times 10^9$	7	$1.9 \times 10^5$	0.57
Medium-sized	$5.7 \times 10^8$	4	$1.3 \times 10^6$	3.6
Small-sized	$3.9 \times 10^8$	12	$3.5 \times 10^6$	11
Typical value			$9.3 \times 10^5$	2.8

<sup>a</sup> From the data in table 26, obtained from the Chinese delegation to the Committee, the coal production per unit of electricity generation could be calculated as between 2.8 and  $3.1 \times 10^6$  t/(GW a).

100. The radioactive content of coal-mine tailings do not differ significantly from background concentrations of natural radionuclides in soil; this situation is different from uranium mining and mill tailings, which have higher concentrations of the natural radionuclides [U9]. This exposure pathway is thus not considered further in this analysis.

101. The typical value for the radon emission (based on discharges of radon during one year) normalized to electricity generated obtained from the Chinese data, 2.8 TBq/(GW a), has been used with the electricity generation data from table 2 and the Committee’s revised methodology for estimating public exposures due to radioactive discharges (annex A) to assess the radiological impact from this source. The default population distribution (see section III.A) was used and the radon was assumed to be released on its own with account taken of its short-lived progeny ( $^{218}\text{Po}$ ,  $^{214}\text{Pb}$ ,  $^{214}\text{Bi}$ , and  $^{214}\text{Po}$ ) in estimating the doses from inhalation.

## (b) *Electricity generation from combustion of coal*

102. Coal combustion in power plants results in the direct release of gaseous radionuclides, and the production of ash with enhanced concentrations of natural radionuclides relative to those of coal [S4]. A fraction of the ash produced is released to atmosphere, dependent on the particulate collection devices used in the power plant. Modern coal-fired power plants have more efficient particulate collection devices than older coal-fired power plants.

103. To assess the doses due to atmospheric releases from coal-fired power plants, a representative case was considered. The coal (e.g. hard coal) was assumed to have an energy equivalent of 24 GJ/t with a power generation efficiency of 38% [I13]. Although the values of  $^{238}\text{U}$  concentrations shown in table 25 show wide variations, an average  $^{238}\text{U}$  concentration of 20 Bq/kg was chosen, based on typical values for Chinese coal reported as 10–25 Bq/kg [I10]. China is the largest producer of coal worldwide, so the value of 20 Bq/kg for the  $^{238}\text{U}$  concentration in coal was considered reasonable as a typical average global value. Other studies have also found a normal range of 20–25 Bq/kg observed globally for good quality coal [S4, T1, U6]. A value of 20 Bq/kg for the  $^{238}\text{U}$  concentration in coal had also been used in the UNSCEAR 1988 Report [U7]. It should also be noted that the resulting individual and collective doses calculated by the revised methodology for estimating public exposures due to radioactive discharges (annex A) are directly proportional to the  $^{238}\text{U}$  concentration in coal.

104. Two different release rates were evaluated to represent the discharge characteristics of older coal-fired power plants and modern coal-fired power plants (table 27). The relative distribution among the different radionuclides in table 27 for the older plants were taken from Hedvall and Erlandsson [H2] while the same for the modern plants were based on Zeevaert et al. [Z1]. The key difference between the two data sets is that  $^{222}\text{Rn}$  concentrations in the discharges are 100 times larger than  $^{226}\text{Ra}$  in older plants and 1,500 larger than  $^{226}\text{Ra}$  in modern plants that have more efficient filtering systems. However, in both cases the value for the discharge of lead and polonium particles has been chosen as twice that of uranium and radium [C4, T1]. Because radon is a noble gas, it is unaffected by filters. As seen from table 27, these releases are not in secular equilibrium. The distribution of older versus modern coal-fired power plants in the various regions of the world is not well-characterized so the results from both cases are included to illustrate the difference in the resulting doses.

105. The assessments presented in this annex using the Committee's revised methodology for estimating public exposures due to radioactive discharges (annex A) do not include dose contributions from  $^{40}\text{K}$  or the  $^{232}\text{Th}$  decay chain. The absorption of  $^{40}\text{K}$  in humans is homeostatically controlled and therefore any doses from  $^{40}\text{K}$  discharges have been neglected. The contribution of the  $^{232}\text{Th}$  decay chain to exposures due to electricity generation from coal combustion has been studied by Zeevaert et al. [Z1]. They found that the concentrations of the radionuclides in the  $^{238}\text{U}$  and  $^{232}\text{Th}$  decay chains in flue gases discharged were similar. The largest contribution to individual doses came from deposition, with consumption of food crops dominating. In this category, the contribution from the  $^{238}\text{U}$  decay series was one order of magnitude larger than the contribution from the  $^{232}\text{Th}$  decay series. Although inclusion of the  $^{232}\text{Th}$  decay series may lead to somewhat higher doses from electricity generation due to coal combustion, it was excluded from the analysis in this annex.

106. Aquatic discharges from coal-fired power plants may lead to additional exposure of local population groups, but this contribution has been found to be small and site-specific [L2, Z1], and were therefore not considered here.

Table 27. Releases to atmosphere (during one year) normalized to electricity generated from coal-fired power plants, based on a representative coal containing 20 Bq/kg of <sup>238</sup>U

Radionuclide	Normalized release (TBq/(GW a))	
	Older coal-fired power plants <sup>a</sup>	Modern coal-fired power plants <sup>b</sup>
<sup>222</sup> Rn	0.07	0.07
<sup>210</sup> Po	$1.4 \times 10^{-3}$	$9.3 \times 10^{-5}$
<sup>210</sup> Pb	$1.4 \times 10^{-3}$	$9.3 \times 10^{-5}$
<sup>226</sup> Ra	$0.7 \times 10^{-3}$	$4.7 \times 10^{-5}$
<sup>234</sup> U	$0.7 \times 10^{-3}$	$4.7 \times 10^{-5}$
<sup>238</sup> U	$0.7 \times 10^{-3}$	$4.7 \times 10^{-5}$
<sup>230</sup> Th	$0.7 \times 10^{-3}$	$4.7 \times 10^{-5}$

<sup>a</sup> Relative radionuclide distribution source: [H2].

<sup>b</sup> Relative radionuclide distribution source: [Z1].

### (c) Radon discharges from coal ash disposed in landfills

107. Coal ash is also referred to as coal combustion residuals (CCR) and coal combustion products (CCP) depending on the industry and the country, and is one of the larger streams of industrial waste generated in the United States [U21]. Coal ash includes a number of by-products from combustion of coal including: fly ash; (furnace) bottom ash; fluidized bed combustion ash; boiler slag; semi-dry absorption product; and flue gas desulphurization gypsum.

108. The coal ash collected from a power plant is either recycled for beneficial use or it is disposed of in landfills or impoundments. Figure VII shows a time history of fly ash production and the fraction used for construction in the period 1966–2010 in the United States [A1]. Approximately 40% was used commercially, leaving the remaining 60% for disposal. This does not include bottom ash, but the proportion sent for disposal was similar [A2].

109. Conventional back-filling or earthmoving operations are used to dispose of the coal combustion residues (CCR) in dry or slightly moist conditions. Impoundments represent a wet disposal method where the CCR is mixed with water at the power station and conveyed hydraulically through pipelines to artificial lagoons where the slurry is discharged. According to the Electric Power Research Institute [E3], about 60% of the disposed fly ash in the United States is managed dry in landfills, and 40% is managed wet in impoundments, and it noted that there was a long-term trend toward increased use of dry management practices [E3].

110. Earlier studies concluded that the individual doses to the public due to radioactive discharges from deposited coal ash were below values relevant from an individual radiation protection viewpoint (e.g. [U23]). The main reason was that the fraction of radon emanating from coal ash is small. This pathway was however considered relevant in the current assessment for collective doses given that the amount of coal ash produced is large and could be significant to the comparisons of collective doses. Also, a similar pathway was considered from the uranium mill tailings in the nuclear fuel cycle motivating a comparison between these two pathways.

Figure VII. Fly ash production and use in the United States (1966–2010) [A1]

(Blue = production, Red = used as a construction material in a variety of applications)

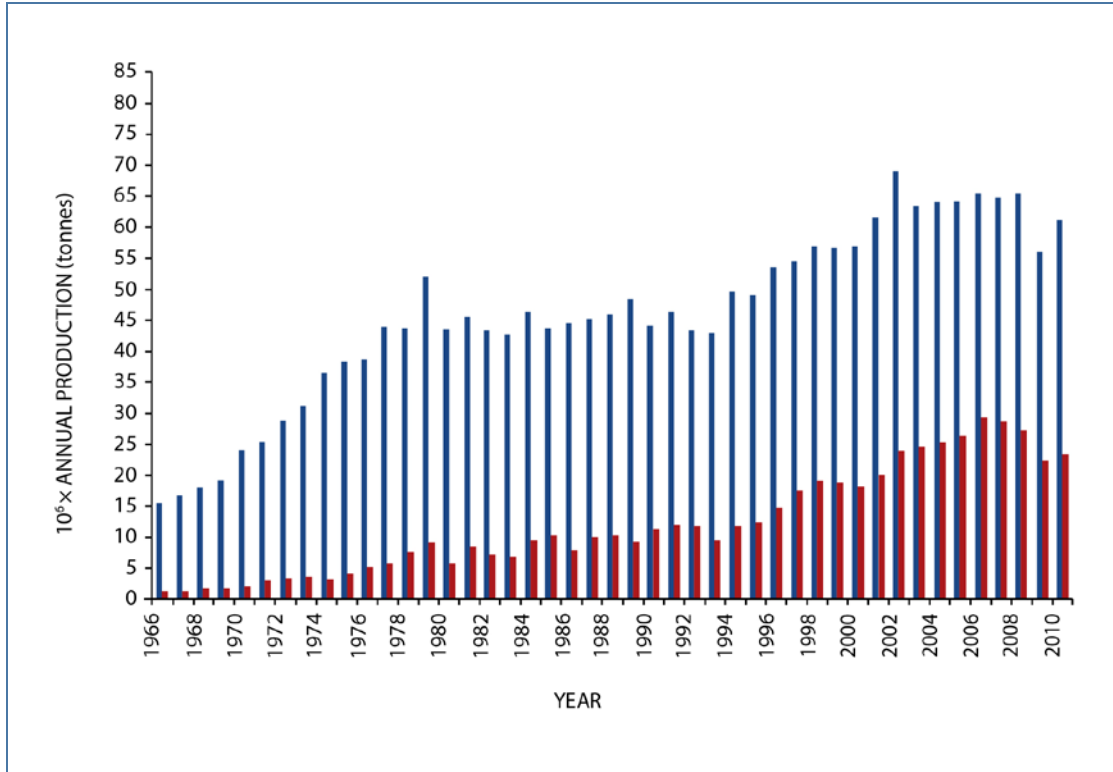

111. *Method for treating the radon discharge from coal ash deposits.* The amount of radon released to atmosphere from coal ash depends on the activity concentration of radon in the ash, which is related to the activity concentration of  $^{226}\text{Ra}$ , and the extent to which the radon produced in the ash is emitted to atmosphere. A recent comprehensive review of radon emanation measurements for mineral, rock, soil, mill tailings and fly ash found the radon emanation fraction (the ratio of the radon emitted to that generated in the mill tailings (or ash deposits) per unit volume) for mill tailings (mostly uranium mill tailings) was 0.17 and for fly ash was 0.03 [S1]. In another study [S6] the radon emanation fraction for coal ash was found to be between 0.08 and 0.13 [S6]. In summary, the first cited study estimated a radon emanation from coal fly-ash of about 20% of the radon emanation from uranium mill tailings, and the second study estimated a value of about 50%. A representative average concentration of  $^{226}\text{Ra}$  in coal ashes (fly- and bottom-ash) was taken as 100 Bq/kg [M2].

112. The  $^{222}\text{Rn}$  flux ( $\text{Bq}/(\text{m}^2 \text{ s})$ ) was studied using data from a repository for uranium residues in India [15] and a linear relationship was found between the radon flux and the activity concentration of  $^{226}\text{Ra}$  in the source:

$$^{222}\text{Rn flux (Bq}/(\text{m}^2 \text{ s})) = 8.3 \times 10^{-4} \text{ kg}/(\text{m}^2 \text{ s}) \times ^{226}\text{Ra concentration (Bq/kg)} \quad (1)$$

113. Because the relationship between the radon flux and the radon emanation factor is linear, the constant in the above equation can be assumed to be proportional to the ratio of the radon emanation factors for different sources. Therefore, for fly ash the constant above could be reduced to between

20 and 50% of its value (comparable with the values from the studies cited above for the radon emanation from coal ash as compared to uranium mine tailings) to obtain an estimate of the  $^{222}\text{Rn}$  flux from coal ash based on the  $^{226}\text{Ra}$  concentration in coal ash. A value of 20% was used in this analysis, giving a linear constant in the above relationship of  $1.7 \times 10^{-4} \text{ kg}/(\text{m}^2 \text{ s})$ .

114. According to a survey in the United States regarding the disposal of solid waste from coal-fired power plants, a value for the area needed for disposing of solid wastes normalized to electricity generated was reported as 2–11  $\text{m}^2/(\text{GW h})$  [A9, F3]. A central value of 6  $\text{m}^2/(\text{GW h})$  was used for this analysis. Multiplying the radon flux during one year, obtained by using equation (1), with the linear constant adjusted for coal ash and a  $^{226}\text{Ra}$  concentration of 100 Bq/kg, with the area needed for disposing of solid wastes normalized to electricity generated, gave the source term for the annual discharge of  $^{222}\text{Rn}$  from deposited coal ashes of about 0.03 TBq/(GW a).

115. A similar value was reached by an independent method. This assessment used an annual discharge of 0.1 TBq/(GW a) as the source term for radon discharges from uranium mill tailings, one part of the nuclear fuel cycle. Using the source term 0.1 TBq/(GW a) for radon discharge from uranium mill tailings and reducing it to 20 to 50% gives an estimate for the annual discharge of radon from coal ash of 0.02–0.05 TBq/(GW a), agreeing well with the value 0.03 TBq/(GW a) obtained from the alternate assessment above.

116. The amount of ash placed in disposal was assumed to be 60% of the total ash produced in coal power plants, based on data cited earlier from the United States and the United Kingdom. The larger six coal-producing countries in table 24 are also countries with large land mass and therefore the value of 60% from the United States was assumed appropriate for use in this assessment. The remaining 40% of the ashes were assumed to be used in a variety of building-related activities and the resulting radiation exposures are discussed in subsection (e).

117. It was explained in paragraph 43 that radon discharges from one gigawatt-year of coal ash deposits were assumed to continue for 100 years and that allowance had to be made in the methodology for this continued discharge. This was done by multiplying the results for one year's discharge by 100 to allow for the discharge continuing for 100 years (see annex A, paragraph 17). Taking into account this multiplication by 100 years and that 60% of the total ash produced in coal-fired power plants was assumed placed in disposals, gave a value for the radon discharge from coal ash deposit normalized to electricity generation of 1.8 TBq/(GW a).

#### *(d) Results—public exposures due to discharges from coal mining, coal-fired power plants and ash deposits*

118. The annual discharges to atmosphere obtained as described above were used to derive individual and collective doses using the revised methodology for estimating public exposures due to radioactive discharges (annex A). The results of the calculation of the characteristic individual doses per unit of electricity generated integrated to 100 years due to atmospheric discharges from the three sources of public exposures from the coal cycle are shown in table 28. These three sources are (a) discharges from coal-fired power plants, (b) discharges from coal ash disposed in landfills and (c) discharges from coal mining. The radon discharges from one gigawatt-year of coal ash deposits were assumed to continue for 100 years. The results are presented for both older coal-fired and for modern coal-fired power plants. If the coal-fired power plants are older, then the individual doses from all three routes are similar, with those from the discharges from power plants being the highest. For newer power plants, the doses due to discharges from the plants are about 10% of those from the other two sources.

119. The values for each region that are shown in table 28 for the characteristic individual doses per unit of electricity generation due to radon discharges from coal mining and from coal ash deposits remain constant across the regions. This is because the discharges from mining and from ash deposits are from radon gas and therefore only result in inhalation doses. However, the discharges from coal-fired power plants include the other radionuclides from the  $^{238}\text{U}$  series, as shown in table 27, and result in doses due to deposition and food consumption, which do have variations with geographical region. As described above, the  $^{232}\text{Th}$  series was not considered in these calculations, and earlier assessments by [Z1], imply that this contribution is less than 10% of the contribution from  $^{238}\text{U}$ .

120. The results also show a difference in the characteristic individual doses per unit of electricity generated due to coal-fired power plant discharges between the older and the modern coal-fired plants with the values for the modern plants being about 10% of those for the older plants. It could be expected that the values resulting from discharges from ash would differ between the older and the modern coal-fired power plants, but this is not reflected in table 28. This is because the actual difference in the amount that remains in the ash for an older versus a modern coal-fired power plant is very small, of the order of about 1%, and for both cases most of the radionuclides stay in the ash. This difference therefore does not show up in the results.

121. The collective doses to the public integrated to 100 years due to electricity generation from the coal cycle for each region and for the world as a whole are shown for the total electricity generated from coal in the year 2010 in table 29. Both cases, assuming (a) that all coal-fired plants are older and (b) that all coal-fired plants are modern, are compared. Considering the three discharge sources (from mining, power plants and ash deposits), the contribution to the collective dose from the discharges from coal-fired plants dominates for the older coal-fired plants, but is the smallest term for the modern plants where the contribution from mining is largest. To facilitate comparison, table 30 compares only the terms from the older versus modern coal-fired power plants.

Table 28. Summary of characteristic individual doses per unit of electricity generated integrated to 100 years due to atmospheric discharges from coal-fired power plant sources (mSv/(GW a))

Source	Africa	Asia and Pacific	Europe	Latin America	North America
From mining	$2.4 \times 10^{-4}$	$2.4 \times 10^{-4}$	$2.4 \times 10^{-4}$	$2.4 \times 10^{-4}$	$2.4 \times 10^{-4}$
From older coal plants	$3.8 \times 10^{-4}$	$4.0 \times 10^{-4}$	$4.2 \times 10^{-4}$	$3.9 \times 10^{-4}$	$4.2 \times 10^{-4}$
From modern coal plants	$3.1 \times 10^{-5}$	$3.2 \times 10^{-5}$	$3.4 \times 10^{-5}$	$3.2 \times 10^{-5}$	$3.4 \times 10^{-5}$
From ash <sup>a</sup>	$1.5 \times 10^{-4}$	$1.5 \times 10^{-4}$	$1.5 \times 10^{-4}$	$1.5 \times 10^{-4}$	$1.5 \times 10^{-4}$

<sup>a</sup> The annual discharges of radon from coal ash produced per unit of electricity generated are assumed to continue for 100 years.

Table 29. Summary of collective doses to the public integrated to 100 years for the total electricity generated from combustion of coal (in 2010) (man Sv)

<i>Discharge type and source</i>	<i>Africa</i>	<i>Asia and Pacific</i>	<i>Europe</i>	<i>Latin America</i>	<i>North America</i>	<i>World</i>
<b>LOCAL COMPONENT<sup>a</sup> – ATMOSPHERIC DISCHARGES</b>						
Mining	$1.0 \times 10^0$	$7.1 \times 10^1$	$8.6 \times 10^0$	$3.8 \times 10^{-1}$	$3.4 \times 10^0$	$7.0 \times 10^1$
Older coal plants	$1.8 \times 10^0$	$1.3 \times 10^2$	$1.9 \times 10^1$	$7.1 \times 10^{-1}$	$7.4 \times 10^0$	$1.4 \times 10^2$
Modern coal plants	$1.5 \times 10^{-1}$	$1.1 \times 10^1$	$1.5 \times 10^0$	$5.6 \times 10^{-2}$	$5.8 \times 10^{-1}$	$1.1 \times 10^1$
Ash <sup>b</sup>	$6.7 \times 10^{-1}$	$4.6 \times 10^1$	$5.5 \times 10^0$	$2.4 \times 10^{-1}$	$2.2 \times 10^0$	$4.5 \times 10^1$
Total (assuming all older coal plants)	$3.5 \times 10^0$	$2.5 \times 10^2$	$3.3 \times 10^1$	$1.3 \times 10^0$	$1.3 \times 10^1$	$2.5 \times 10^2$
Total (assuming all modern plants)	$1.9 \times 10^0$	$1.3 \times 10^2$	$1.6 \times 10^1$	$6.8 \times 10^{-1}$	$6.2 \times 10^0$	$1.3 \times 10^2$
<b>REGIONAL COMPONENT<sup>c</sup> – ATMOSPHERIC DISCHARGES</b>						
Mining	$4.5 \times 10^0$	$3.0 \times 10^2$	$3.7 \times 10^1$	$1.6 \times 10^0$	$1.5 \times 10^1$	$3.0 \times 10^2$
Older coal plants	$8.7 \times 10^0$	$6.4 \times 10^2$	$9.0 \times 10^1$	$3.4 \times 10^0$	$3.5 \times 10^1$	$6.4 \times 10^2$
Modern coal plants	$6.9 \times 10^{-1}$	$5.0 \times 10^1$	$6.9 \times 10^0$	$2.6 \times 10^{-1}$	$2.7 \times 10^0$	$5.0 \times 10^1$
Ash <sup>b</sup>	$2.9 \times 10^0$	$2.0 \times 10^2$	$2.4 \times 10^1$	$1.0 \times 10^0$	$9.4 \times 10^0$	$1.9 \times 10^2$
Total (assuming all older coal plants)	$1.6 \times 10^1$	$1.1 \times 10^3$	$1.5 \times 10^2$	$6.0 \times 10^0$	$5.9 \times 10^1$	$1.1 \times 10^3$
Total (assuming all modern plants)	$8.0 \times 10^0$	$5.5 \times 10^2$	$6.7 \times 10^1$	$2.9 \times 10^0$	$2.7 \times 10^1$	$5.5 \times 10^2$
<b>TOTAL LOCAL AND REGIONAL COMPONENTS – ATMOSPHERIC DISCHARGES</b>						
Mining	$5.5 \times 10^0$	$3.7 \times 10^2$	$4.5 \times 10^1$	$2.0 \times 10^0$	$1.8 \times 10^1$	$3.7 \times 10^2$
Older coal plants	$1.1 \times 10^1$	$7.7 \times 10^2$	$1.1 \times 10^2$	$4.1 \times 10^0$	$4.3 \times 10^1$	$7.8 \times 10^2$
Modern coal plants	$8.3 \times 10^{-1}$	$6.0 \times 10^1$	$8.3 \times 10^0$	$3.2 \times 10^{-1}$	$3.3 \times 10^0$	$6.0 \times 10^1$
Ash <sup>b</sup>	$3.5 \times 10^0$	$2.4 \times 10^2$	$2.9 \times 10^1$	$1.3 \times 10^0$	$1.2 \times 10^1$	$2.4 \times 10^2$
Total (assuming all older coal plants)	$2.0 \times 10^1$	$1.4 \times 10^3$	$1.8 \times 10^2$	$7.4 \times 10^0$	$7.2 \times 10^1$	$1.4 \times 10^3$
Total (assuming all modern plants)	$9.9 \times 10^0$	$6.8 \times 10^2$	$8.3 \times 10^1$	$3.6 \times 10^0$	$3.3 \times 10^1$	$6.7 \times 10^2$

<sup>a</sup> The local component of collective dose is calculated for people living between 0 and 100 km from the discharge point.

<sup>b</sup> The discharges of radon from coal ash produced in 2010 from electricity generation are assumed to continue for 100 years.

<sup>c</sup> The regional component of collective dose is calculated for people living between 100 and 1,500 km from the discharge point.

Table 30. Comparison of collective doses to the public integrated to 100 years from coal-fired power plants given alternative plant design (man Sv)

<i>Doses from coal-fired power plants</i>	<i>Collective doses to the public integrated to 100 years (man Sv)</i>					
	<i>Africa</i>	<i>Asia and Pacific</i>	<i>Europe</i>	<i>Latin America</i>	<i>North America</i>	<i>World</i>
LOCAL COMPONENT <sup>a</sup> – ATMOSPHERIC DISCHARGES						
Older coal plants	1.8 × 10 <sup>0</sup>	1.3 × 10 <sup>2</sup>	1.9 × 10 <sup>1</sup>	7.1 × 10 <sup>-1</sup>	7.4 × 10 <sup>0</sup>	1.4 × 10 <sup>2</sup>
Modern coal plants	1.5 × 10 <sup>-1</sup>	1.1 × 10 <sup>1</sup>	1.5 × 10 <sup>0</sup>	5.6 × 10 <sup>-2</sup>	5.8 × 10 <sup>-1</sup>	1.1 × 10 <sup>1</sup>
REGIONAL COMPONENT <sup>b</sup> – ATMOSPHERIC DISCHARGES						
Older coal plants	8.7 × 10 <sup>0</sup>	6.4 × 10 <sup>2</sup>	9.0 × 10 <sup>1</sup>	3.4 × 10 <sup>0</sup>	3.5 × 10 <sup>1</sup>	6.4 × 10 <sup>2</sup>
Modern coal plants	6.9 × 10 <sup>-1</sup>	5.0 × 10 <sup>1</sup>	6.9 × 10 <sup>0</sup>	2.6 × 10 <sup>-1</sup>	2.7 × 10 <sup>0</sup>	5.0 × 10 <sup>1</sup>
TOTAL LOCAL AND REGIONAL COMPONENTS – ATMOSPHERIC DISCHARGES						
Older coal plants	1.1 × 10 <sup>1</sup>	7.7 × 10 <sup>2</sup>	1.1 × 10 <sup>2</sup>	4.1 × 10 <sup>0</sup>	4.3 × 10 <sup>1</sup>	7.8 × 10 <sup>2</sup>
Modern coal plants	8.3 × 10 <sup>-1</sup>	6.0 × 10 <sup>1</sup>	8.3 × 10 <sup>0</sup>	3.2 × 10 <sup>-1</sup>	3.3 × 10 <sup>0</sup>	6.0 × 10 <sup>1</sup>

<sup>a</sup>The local component of collective dose is calculated for people living between 0 and 100 km from the discharge point.

<sup>b</sup>The regional component of collective dose is calculated for people living between 100 and 1,500 km from the discharge point.

### (e) Coal ash in building materials

122. Coal combustion products (CCPs) are used as ingredients in a variety of construction materials including concrete, grouting, fill material, lightweight aggregate, road construction or maintenance materials, and in soil stabilization [U1].

123. Fly ash and furnace bottom ash are the main CCPs and the extent to which they are utilized varies by country. Approximately 40% of CCPs produced in the United States are utilized in construction materials [A2], and the percentage utilization was around 45% in the European Union [E2] for fly ash and bottom ash CCPs produced in 2010. China is the largest producer of electricity from combustion of coal and consequently the largest producer of coal ash. According to Tang et al. [T2], China produces proportionately more coal ash because it has a very low coal washing rate (51%). In 2010, the fly ash utilization rate in China was over 65% [T2]. In contrast, in 2009 less than 20% of CCPs produced in Australia were utilized [H3].

124. As noted previously, the activity concentration of natural radionuclides in coal ash is increased relative to coal by a factor of 5–10. However, the concentration is again diluted when the fly ash is mixed with other materials to form construction material. The presence of fly ash in building materials may increase indoor exposures to gamma radiation from <sup>226</sup>Ra, <sup>232</sup>Th and <sup>40</sup>K contained in the coal ash, and exposures due to inhalation of radon emanating from the building construction material such as concrete [D3, F1, T4].

125. The relationship between coal ash in construction material and exposure is not straightforward. The use of coal ash has been shown to either increase, decrease or have essentially no effect on exposures relative to traditional construction materials [T4]. This reflects differences in the source of the coal, the natural radionuclide content of the traditional construction materials, and to the changes in structural properties of the construction material. For example, the use of fly ash and furnace slag in concrete has been shown to reduce radon exhalation rates because it alters the porosity and chemistry of



the construction material [D3, D4]. As of the year 2016 there are no consistent or internationally accepted limits for radionuclides in building materials.

126. A population-weighted average annual effective dose of 0.41 mSv from indoor exposure to gamma rays mainly determined by construction materials was reported by UNSCEAR [U9]. The results for individual countries generally ranged between 0.3 and 0.6 mSv. A more recent analysis by de Jong et al. [D3] calculated an annual effective dose of 0.32 mSv for the Netherlands, which is at the lower end of the range given by UNSCEAR [U9]. In both evaluations, the results included dwellings where fly ash was used in the construction material.

127. Collective doses either for geographical region or for the world as a whole due to the use of coal ash in building materials have not been analysed further in this study. Although the individual doses that have been assessed are very low, some contribution to the total collective dose can be expected from the use of coal ash in construction materials. However, the various factors causing variability in the exposure characteristics cause major uncertainty in the assessments.

### 3. Occupational exposures from coal mining

128. Previous UNSCEAR studies have estimated the collective doses due to occupational exposure from coal mining. In the UNSCEAR 1988 Report [U7], based on exposure data from British coal mining and the worldwide coal production rate, the worldwide collective dose was estimated as 2,000 man Sv. The UNSCEAR 2000 Report [U9] updated this value to an estimated 2,600 man Sv. The UNSCEAR 2008 Report estimated the worldwide collective dose to workers from coal mining in 2002–2004 at 16,560 man Sv in a year [U11]. Most of the data on occupational exposure from coal mining that were used in the UNSCEAR 2008 Report came from China. A study on radiation levels in China reported the annual average collective dose to underground coal miners in 2003–2004 as 16,500 man Sv [L1]. In addition, occupational exposures from coal mining in the United Kingdom in 2002 were reported in the UNSCEAR 2008 Report [U11] as 3 man Sv for 5,000 coal miners and an average individual dose of 0.6 mSv.

129. The worldwide collective dose to coal miners in 2010 could be estimated from the 2002 collective dose value assuming that the increase in electricity generation from coal in the period 2002–2010 was proportional to the increase in occupational exposure due to coal mining for the same time span. This assumed that the same collective dose normalized to electricity generation that was assessed for 2002–2004 [U11] was applicable for 2010 and that the efficiency of coal mining remained the same, i.e. the same number of coal miners was needed to obtain the same amount of coal. The electricity generated from coal-fired power plants in the reference year of 2010 was 992 GW a (table 2). The corresponding number for the period of 2002–2004 considered in the UNSCEAR 2008 Report was 720 GW a [I12]. This gave a rounded worldwide estimate of the collective dose to coal miners of 23,000 man Sv, as a first approximation.

130. Table 31 shows results from a Chinese study [L1], together with data on the number of coal miners in three categories of mines in China for 2010 [W2]. No new values of the average annual effective dose to coal miners have been published since the 2010 values in table 31.

131. Chinese coal production between 2004 and 2010 increased by approximately 50%. During this period, there was an increase in the number of underground miners working at medium- and large-sized coal mines and a significant decrease in the number working in small-sized township and privately-owned coal mines [W2]. The last column in table 31 uses the average annual effective dose from 2004 and the number of coal miners in 2010 to estimate the collective dose in 2010 in China for the three

coal-mine categories: small, medium and large. This can be compared to the collective dose in 2002–2004, also shown in the table. (The number of bone-coal miners in China in 2010 was not available, although this group represented a small fraction of the total in the 2004 data.) This approach gave an estimated collective dose in 2010 for coal miners in China of about 10,000 man Sv.

132. During the period 2002–2004, China accounted for almost 90% of the underground coal miners in the world. Assuming that the proportion of underground coal miners from countries worldwide was about the same in 2010 as in 2002–2004, the total world collective dose to coal miners was estimated to be about 11,000 man Sv (compared to 23,000 man Sv obtained using the simpler approach above). This can also be compared to the value 16,560 man Sv that was reported in the UNSCEAR 2008 Report [U11]. The implied decrease would be due to more efficient coal-mining technology for underground coal extraction and to the closing of many of the smaller, less efficient coal mines with poor ventilation [W2].

133. The dose contribution for thorium and its decay products and aerosols containing long-lived alpha-emitting radionuclides were not assessed in this study [L1]. In the past, the effective dose from aerosols containing long-lived alpha-emitting radionuclides was roughly estimated by using the contents of radioactive material in the coal and the concentrations of dust in underground coal mines. The estimation indicated that the annual individual dose ranges from several to ten microsieverts, which has been assumed to be of little significance in this comparative study.

Table 31. Annual doses to underground coal miners in China [L1]

The information in the table for number of miners for the year 2010 was obtained from an official communication from the Chinese delegation to the Committee

Type of coal mine	Average annual effective dose (2004) (mSv)	Number of miners in 2004 (millions)	Number of miners in 2010 (millions)	Collective dose 2002–2004 (man Sv)	Collective dose in 2010, using average annual effective dose from 2004 and number of miners in 2010 (man Sv)
Large-sized	0.32	1	1.26	315	403
Medium-sized	0.63	1	1.31	630	825
Small-sized	3.78	4	2.27	15 100	8 581
Bone-coal	11.3	0.05	Not available	567	Not available
Total	2.75 (weighted average)	6.05	4.84	16 612	9 809

## B. Natural gas

134. According to table 2 the global combustion of natural gas produced 544 GW a of electrical energy in 2010. This amount of electrical energy was second only to that due to the combustion of coal at 992 GW a and was 1.7 times the amount of electricity generated by nuclear power plants. The generation of 1 kW h of electrical energy has been estimated to require the combustion of 0.286 m<sup>3</sup> of natural gas [U20].

135. Natural gas is essentially methane (CH<sub>4</sub>) with trace amounts of other materials. The most important radionuclide released during the combustion of natural gas is <sup>222</sup>Rn. Several authors have

reported on the concentration of  $^{222}\text{Rn}$  in natural gas as measured at the wellhead or at various other locations in the gas-delivery system. In developed countries, natural gas is typically not used directly from the wellhead, but is processed to remove moisture and refrigerated to condense and remove higher chain gases, including ethane ( $\text{C}_2\text{H}_6$ ), propane ( $\text{C}_3\text{H}_8$ ) and butane ( $\text{C}_4\text{H}_{10}$ ). The condensation process is important, because radon tends to condense with ethane and propane [D6, G2]. Gesell [G2] studied nine gas-processing plants and found that, on average, the  $^{222}\text{Rn}$  content of gas ready to be sold for combustion (the sales gas) was 34% of that at the wellhead (the input gas) with a range of 4 to 90%. Further, natural gas may be transported by pipeline over long distances and is also typically stored at locations near its end use. Because the half-life of  $^{222}\text{Rn}$  is 3.8 days, appreciable decay can occur between the production and combustion of natural gas.

136. Measured values of  $^{222}\text{Rn}$  in natural gas are summarized in table 32. The range of individual values was large; the weighted average of 879 samples was  $625 \text{ Bq/m}^3$ . Most of the values in table 32 were for samples taken at the wellhead. Considering the processes that reduce the concentration of radon from the gas at the wellhead to the gas sold for combustion [V2], a value of  $300 \text{ Bq/m}^3$  was considered to be a reasonable estimate.

Table 32. Summary of reported concentrations of  $^{222}\text{Rn}$  in samples of natural gas

Unless noted otherwise, the samples were taken at or near the wellhead. Concentration values are in units of  $\text{Bq/m}^3$

Source	Area	Number of samples	Minimum value	Maximum value	Mean
[B9]	NW New Mexico SW Colorado	307	7.4	5 880	910
[M4]	NW New Mexico SW Colorado	42	11.8	2 130	610
[G2]	Texas, Oklahoma, Louisiana	15	37	4 400	1 330
[V1]	Netherlands, Germany, North Sea, Borneo, Nigeria	~200	33	1 650	74 <sup>a</sup>
[K2]	N. Germany	196	—	4 000	580
[V2]	British Columbia	~32	7	921	272
[O9]	Ireland	8 <sup>b</sup>	116	918	638
[A4] <sup>c</sup>	Syrian Arab Republic	36	15	1 142	400
[R4]	Pennsylvania	21	37	2 920	1 370
[P2]	Pennsylvania	22	110	5 476	1 770
	Weighted average	879			625

<sup>a</sup> Average results for the Netherlands only.

<sup>b</sup> Same field sampled at various times.

<sup>c</sup> Taken at many locations, including those in gas-processing plants.

137. The calculation of the activity of  $^{222}\text{Rn}$  released normalized to electricity generated is thus given as

$$0.2860 \frac{\text{m}^3}{\text{kW} \cdot \text{h}} \times 300 \frac{\text{Bq}}{\text{m}^3} \times 8760 \frac{\text{h}}{\text{a}} \times 10^6 \frac{\text{kW}}{\text{GW}} \times 10^{-12} \frac{\text{TBq}}{\text{Bq}} = 0.75 \frac{\text{TBq}}{\text{GW} \cdot \text{a}} \quad (2)$$

This value for the release of  $^{222}\text{Rn}$  normalized to electricity generated was used with UNSCEAR's revised methodology for estimating public exposures due to radioactive discharges (annex A). The 2010 data on electricity generation from natural gas for each region, shown in table 2, were used, and the default population distribution based on population densities for 2010 was used for the collective doses (see paragraph 34). The resulting characteristic individual and collective doses are compared with those for other electricity-generating technologies in table 33 (for characteristic individual doses) at the end of this chapter and in table 46 (for collective doses) in chapter VIII.

138. Other radionuclides can appear in natural gas. One of them is  $^{220}\text{Rn}$ , but its half-life (55.6 s) is too short for it to appear at the point of end use of the gas for combustion. If water is co-produced with natural gas, the water may contain soluble amounts of radium. Radium-226 is the parent of  $^{222}\text{Rn}$  and is a decay product of  $^{238}\text{U}$ ;  $^{224}\text{Ra}$  is the parent of  $^{220}\text{Rn}$  and is a decay product of  $^{228}\text{Ra}$  and ultimately of  $^{232}\text{Th}$  (see figure III). The progeny of the three radium isotopes and  $^{222}\text{Rn}$  can also be present in natural gas, but typically in small amounts. Lead-210 is a longer-lived (half-life of 22.2 years) decay product of  $^{226}\text{Ra}$  and  $^{222}\text{Rn}$ , and van der Heijde et al. noted that the activities of  $^{210}\text{Pb}$  and its decay product  $^{210}\text{Po}$  in natural gas are more than can be accounted for by the decay of  $^{226}\text{Ra}$  and  $^{222}\text{Rn}$  [V1]. These authors concluded that the additional  $^{210}\text{Pb}$  and  $^{210}\text{Po}$  had been produced from the natural gas reservoir. In general, these radionuclides other than radon do not reach the end point of combustion of natural gas, but they typically plate out within the gas-distribution system fairly close to the point of withdrawal and/or treatment. Because the radionuclides are contained within equipment, workers can incur external exposure to radiation. Organo and Fenton [O9] concluded after investigations in Ireland that workers at offshore locations would be exposed "at most" to around 100  $\mu\text{Sv}$  in a year. The Pennsylvania Department of Environmental Protection [P2] measured the external ambient dose rate at several locations within gas production and processing sites and estimated a maximum annual average dose of 270  $\mu\text{Sv}$ . The Committee has assumed a reasonably realistic estimate of 100  $\mu\text{Sv}$  in a year.

139. A problem in estimating the collective effective dose to workers is determining the number of workers in the industry apportioned to the amount of natural gas used to generate electricity. An indirect method was used to make this determination. According to the United States Bureau of Labor Statistics [U16], there were 89,000 production and non-supervisory workers in the oil- and gas-extraction subsector. Most of these workers were not working directly in support of natural gas production for electricity generation, but there was no further breakdown in the data. In order to estimate the fraction of workers supporting the generation of electrical energy by combustion of natural gas, data from [I17] for the OECD countries for 2010 were used. In terms of energy produced, these data indicated that 12% of the energy produced from oil and natural gas together was used for electricity generation due to combustion of natural gas. Thus, it was estimated that 10,700 workers were employed in the United States to produce natural gas for the generation of electricity.

140. According to [U19] 209.2 billion cubic metres of natural gas were used in 2010 to produce electricity in the United States. With the use of previously mentioned conversion factors this was equivalent to 83.5 GW a of electrical energy. Thus, the normalized collective dose for workers based on the data originating in the United States was 0.013 man Sv/(GW a).

## C. Oil

141. The combustion of oil for electricity generation accounted for less than 5% of the world's electricity generation in 2010, but accounted for more than 30% of electrical energy generated in West Asia. The generation of 1 kW h of electrical energy is estimated to require the combustion of 0.278 L of petroleum [U20]. Most of the “petroleum” combusted to generate electricity in 2010 in the OECD countries consisted of fuel oil [I17], which has an approximate density of 0.95 kg/L.

142. Petroleum is produced from underground reservoirs in the presence of geological formations that contain the primordial radionuclides  $^{40}\text{K}$ ,  $^{238}\text{U}$  and  $^{232}\text{Th}$ ; the latter two are parents of chains that produce a series of radionuclides usually present in secular equilibrium (see figure III). A process that can perturb the secular equilibrium is the dissolution of some members of the chain in water, which at depth can be at high temperature. Water containing dissolved radium is typically co-produced with oil. Radium-226 is a member of the chain headed by  $^{238}\text{U}$ ;  $^{226}\text{Ra}$  is the parent of  $^{222}\text{Rn}$  and an additional series of decay products including  $^{210}\text{Pb}$  and  $^{210}\text{Po}$ . Radium-228 is a member of the chain headed by  $^{232}\text{Th}$ ;  $^{228}\text{Ra}$  is the parent of  $^{224}\text{Ra}$  and  $^{220}\text{Rn}$ . Both  $^{226}\text{Ra}$  and  $^{224}\text{Ra}$  are parents of additional short-lived beta or gamma-emitting radionuclides.

143. Apparently some power plants can burn crude (or heavy) oil with its associated natural gas [A5], but it is more typical that associated natural gas and water produced in the process must be removed from petroleum before delivery to a pipeline or refinery [S5]. Radon is more typically associated with natural gas and the soluble isotopes of radium are typically associated with the produced water. As produced water is withdrawn from depth, it cools and dissolved minerals, including radium, can form precipitates and deposit on the production tubing and on various other production equipment. These deposits are known as scale or sludge. With time the radium contained within scale and sludge will come into equilibrium with gamma-emitting decay products and give rise to external exposure of workers.

144. There are many studies of the presence of radionuclides in scale, sludge, (e.g. [I1, R3]) and produced water [S5], and of radon in natural gas (see section V.B above), but there are few measurements of radium or radon in crude oil or its subsequent products. Crude oil generally contains some remaining water within a water-in-oil emulsion and this water contains dissolved radium [S5]. Radon is also quite soluble in oil [B2].

145. The report by Bell et al. [B2] appears to be the only one that reports measurements of both  $^{222}\text{Rn}$  and  $^{226}\text{Ra}$  in the same samples of crude oil. Because the half-life of  $^{222}\text{Rn}$  is 3.82 days, the samples had to be delivered quickly and correction made for decay in transit. Seven samples of crude oil from wells in Texas and Oklahoma were measured. The results for  $^{222}\text{Rn}$  varied from a minimum of 3.2 Bq/kg to a maximum of 17 Bq/kg and had an average of 7 Bq/kg. The results for  $^{226}\text{Ra}$  had a minimum of 0.2 Bq/kg, a maximum of 13 Bq/kg and an average of 0.7 Bq/kg. The ratio of  $^{222}\text{Rn}$  to  $^{226}\text{Ra}$  had a minimum of 4, a maximum of 38, and an average of 15. Thus, most of the  $^{222}\text{Rn}$  in fresh samples of crude oil was unsupported, that is, it was far in excess of the activity that was in equilibrium with  $^{226}\text{Ra}$ . Except for those power plants that burn crude oil directly, this excess  $^{222}\text{Rn}$  would decay or be removed in the refining and/or transportation processes.

146. Hamlat et al. [H1] reported concentrations of  $^{226}\text{Ra}$  in an unspecified number of samples of crude oil collected in Algeria. The range of values was from 6 Bq/kg to 20 Bq/kg; these values are reasonably consistent with those reported by Bell et al. [B2]. Al-Saleh and Al-Harshan [A7] measured radionuclides in 14 petroleum-product samples, including crude oil drawn from the Riyadh City Refinery. The detection limit for  $^{226}\text{Ra}$  was 0.014 Bq/kg; the only products with detectable amounts of  $^{226}\text{Ra}$  were “sweet naphtha” ( $0.65\pm 0.40$  Bq/kg) and “flushing oil” ( $0.45\pm 0.20$  Bq/kg).

147. The limited amount of data indicated above suggests a cautious approach in estimating the release of radionuclides from the combustion of oil products. For this procedure the Committee estimated that there was a concentration of  $^{226}\text{Ra}$  in all oil products of 1 Bq/kg. Further, it assumed that unsupported amounts of  $^{222}\text{Rn}$  decayed or otherwise were eliminated in the process, so that the concentration of  $^{222}\text{Rn}$  in all oil products was also 1 Bq/kg.

148. Then, the normalized release of  $^{222}\text{Rn}$  was calculated as

$$0.278 \frac{\text{L}}{\text{kW} \cdot \text{h}} \times 0.95 \frac{\text{kg}}{\text{L}} \times 1 \frac{\text{Bq}}{\text{kg}} \times 8760 \frac{\text{h}}{\text{a}} \times 10^6 \frac{\text{kW}}{\text{GW}} \times 10^{-12} \frac{\text{TBq}}{\text{Bq}} = 0.002 \frac{\text{TBq}}{\text{GW} \cdot \text{a}} \quad (3)$$

This value for the release of  $^{222}\text{Rn}$  normalized to electricity generated was used with the revised methodology for estimating public exposures due to radioactive discharges (annex A). The 2010 data on electricity generation from oil for each region, shown in table 2, were used, and the default population distribution based on population densities for 2010 was used for the collective doses (see paragraph 34). The resulting characteristic individual and collective doses are compared with those for other electricity-generating technologies in table 33 (for characteristic individual doses) at the end of this chapter and in table 46 (for collective doses) in chapter VIII.

149. There may be other radionuclides emitted by the combustion of oil products; Al-Masri and Haddad [A5] reported values of about 60 Bq/kg of  $^{210}\text{Po}$  in heavy oil fuel used in three power plants in the Syrian Arab Republic. The same authors [A6] also reported that soil in the vicinity of the three power plants contained enhanced levels of  $^{210}\text{Pb}$  and  $^{210}\text{Po}$ . Other authors have not reported measurements of  $^{210}\text{Pb}$  and  $^{210}\text{Po}$  associated with oil-fired power plants.

150. As mentioned above,  $^{226}\text{Ra}$  and  $^{228}\text{Ra}$  and their decay products accumulate in scale and sludge around wellheads and processing equipment. This gives rise to occupational exposure, when workers are in the vicinity of these elements. Kvasnicka [K4] estimated that the maximum effective dose on offshore platforms could be managed to be below 1 mSv in a year. It is expected that the doses to workers on offshore platforms would be higher than on onshore platforms, because of more substantial problems with scale formation and the limited space in the working environment on the platforms. Hamlat et al. [H1] measured ambient dose rates in the vicinity of onshore oil and natural gas production equipment. They estimated that annual effective doses around oil extraction equipment might range from 40 to 600  $\mu\text{Sv}$  for normal activities. A value of 300  $\mu\text{Sv}$  was adopted for this analysis.

151. There were no direct data on the number of workers in the oil industry apportioned to the combustion of oil for the generation of electricity, so an indirect method was used. According to the United States Bureau of Labor Statistics [U16], there were 89,000 production and non-supervisory workers in the oil- and gas-extraction subsector in the United States in 2010. In order to estimate the fraction of workers who were supporting the generation of electrical energy by the combustion of oil, data from [I17] were used. In terms of energy produced these data indicated that only 1.7% of energy produced from oil and natural gas was used for the generation of electricity by the combustion of oil in 2010. Thus, it was estimated that 1,520 workers in the United States could be apportioned to generation of electrical energy by the combustion of oil.

152. According to [U19]  $7.02 \times 10^9$  kg of oil were used in 2010 to generate electricity in the United States. Using the conversion factors given above, this is equivalent to 3.03 GW a of electricity. Thus, the collective dose to workers normalized to the electricity generated, based on data from the United States, was estimated to be 0.15 man Sv/(GW a).

## D. Comparisons of exposures from fossil-fuel electricity generation

153. Table 33 shows characteristic individual doses integrated to 100 years per unit of electricity generated for the UNEP regions. These doses are due to atmospheric discharges from the coal cycle and the combustion of gas or oil in power plants generating electricity. Although the doses resulting from the modern coal plants are about 10% of the doses from the older plants, in total the characteristic individual doses per unit of electricity generated from both the older and the modern coal plants are larger than from the gas or the oil combustion technologies. See chapter VIII for further comparisons between these and other electricity-generation technologies.

Table 33. Summary of characteristic individual doses per unit of electricity generated integrated to 100 years due to atmospheric discharges from the coal cycle and the combustion of gas and oil (mSv/(GW a))

Showing results from both older and modern coal plants

<i>Electricity generation technology</i>	<i>Release</i>	<i>Africa</i>	<i>Asia and Pacific</i>	<i>Europe</i>	<i>Latin America</i>	<i>North America</i>	<i>West Asia</i>
Coal							
- From mining	Radon	$2.4 \times 10^{-4}$	$2.4 \times 10^{-4}$	$2.4 \times 10^{-4}$	$2.4 \times 10^{-4}$	$2.4 \times 10^{-4}$	0
- From older coal plants	Natural radionuclides including radon	$3.8 \times 10^{-4}$	$4.0 \times 10^{-4}$	$4.2 \times 10^{-4}$	$3.9 \times 10^{-4}$	$4.2 \times 10^{-4}$	0
- From modern coal plants		$3.1 \times 10^{-5}$	$3.2 \times 10^{-5}$	$3.4 \times 10^{-5}$	$3.2 \times 10^{-5}$	$3.4 \times 10^{-5}$	0
- From ash	Radon	$1.5 \times 10^{-4}$	$1.5 \times 10^{-4}$	$1.5 \times 10^{-4}$	$1.5 \times 10^{-4}$	$1.5 \times 10^{-4}$	0
Gas	Radon	$6.3 \times 10^{-5}$	$6.3 \times 10^{-5}$	$6.3 \times 10^{-5}$	$6.3 \times 10^{-5}$	$6.3 \times 10^{-5}$	$6.3 \times 10^{-5}$
Oil	Radon	$1.7 \times 10^{-7}$	$1.7 \times 10^{-7}$	$1.7 \times 10^{-7}$	$1.7 \times 10^{-7}$	$1.7 \times 10^{-7}$	$1.7 \times 10^{-7}$

## VI. RADIATION EXPOSURES ARISING FROM ELECTRICITY GENERATION FROM GEOTHERMAL ENERGY

154. Geothermal energy is derived from the heat of the earth at locations where magma is closer than normal to the earth's surface. The generation of electricity from geothermal sources presently depends upon the use of steam or hot water from wells drilled into underground reservoirs. As shown in table 2 [I17], geothermal energy in the reference year 2010 generated 7.77 GW a of electricity and accounted for 0.3% of the total world's electricity generation in 2010.

155. Electricity generation from geothermal sources first began in 1904 at Larderello, Italy, with an experimental 10 kW generator. At the present time the installed capacity is in excess of 9,000 MW in 25 countries [L3]. The larger power plants are at The Geysers, California; Larderello, Italy; Cerro Prieto, Mexico; Leyte, Philippines; Salton Sea, California; Hellisheidi, Iceland; Tiwi and Malitbog, Philippines; and Wayang Windu and Darajat, Indonesia [K1].

156. Different approaches can be taken to generate electricity from geothermal sources. If dry steam is available, the simplest is to run the steam through a turbine and exhaust to the atmosphere. Efficiency is improved if the dry steam is condensed, with heat dissipated through cooling towers. Most reservoirs, however, do not produce dry steam, but some combination of steam and hot water or hot water alone. In this situation, it is necessary to separate steam from water, or, if hot water alone is produced, to flash the water to steam through single, double, or even triple passes. A binary process is in use at some sites that use water of lower temperature; hot water is run through a primary loop and a fluid with a lower boiling point through a secondary loop. As of the year 2016, most electrical energy generation is through the flash process with single or double flash; the other major technology is the use of dry steam with condensation [M3].

157. During the 1970s there was substantial interest in evaluating the potential impact of the release of  $^{222}\text{Rn}$  from gases vented during the operation of geothermal electricity-generating plants. The more complete evaluations were reported for The Geysers and the Larderello Plants. Anspaugh [A10] reported that 19.3 TBq/a were being released from The Geysers during the operation of 11 dry steam condensing units with 502 MW of electrical power; the daily rate was noted to be equivalent to the average daily background emission of  $^{222}\text{Rn}$  from about 40 km<sup>2</sup> of soil. For the Larderello geothermal complex, the emission rate per unit energy was 38.5 TBq/(GW a) according to George et al. [G1]. This was based on measurements performed by D'Amore [D1], who calculated that 300 GBq/d were being released from the Larderello geothermal complex, which had an installed capacity of about 420 MW [P1]. Thus, the emission rate per unit energy at Larderello was 260 TBq/(GW a).

158. The above represent the two situations where data were complete enough to estimate emissions per unit of electricity generated. Based on this limited set of data, the Committee assumed an average value of 150 TBq/(GW a). There are measurements of radon in steam or hot water from other locations, and samples of such data are given in table 34; at the time of the assessment no data were available for the amount of  $^{222}\text{Rn}$  that might be released from geothermal sites using binary circle systems. A reason that data are scarce on radon related to geothermal energy is that, following the measurements in the 1970s, it was generally concluded that this source of radon was not significant compared to the natural exhalation of radon from soil. Measurements of  $^{222}\text{Rn}$  and  $^{220}\text{Rn}$  in geothermal fluids do continue, but are mainly related to understanding of the dynamics of resources [W6].

Table 34. Reported concentrations of  $^{222}\text{Rn}$  in fluids produced from geothermal wells

<i>Location</i>	<i>Activity of <math>^{222}\text{Rn}</math> per unit of produced fluid (Bq/kg)</i>	<i>Reference</i>
The Geysers, weighted average	520	[A10]
The Geysers	620	[K3]
Larderello	1 280	[K3]
Larderello, weighted average	3 100	[G1]
Salton Sea, California	110	[K3]
East Mesa, Imperial Valley, CA	1.1	[K3]
Wairakei, New Zealand	630	[W6]

159. The value of 150 TBq/(GW a) for the release of  $^{222}\text{Rn}$  normalized to electricity generation from geothermal energy was used with the electricity generation data by region from table 2 and with estimates of population density to give an estimate of the characteristic individual and collective doses. There is substantial uncertainty regarding the population density around geothermal power plants, as it is necessary to locate the plants within the narrow confines of the resource. The Geysers and the Cerro



Prieto plants are in isolated locations, but large metropolitan areas are within 1,500 km. The other extremes are geothermal power plants located on islands. Because of these discrepancies and the lack of specific population data on each power plant, the Committee made two calculations for geothermal: one with the assumption of low-density population, as in the assessments for uranium mining and milling, and one with the default population density.

160. Table 46 in chapter VIII compares the collective doses to the public for the discharges from the nuclear fuel cycle, coal cycle, gas, oil and geothermal electricity-generating technologies. As explained in the previous paragraph, two values are given for geothermal energy. The normalized discharge of radon for geothermal electricity generation is the largest of the electricity-generating technologies shown in table 46. However, the impact of geothermal electricity generation remains small because of the limited use of this technology. Further, there is substantial uncertainty regarding the discharge of radon from geothermal power plants; data are available for only two plants, and the estimated discharges from these two plants vary substantially.

161. There are even fewer data on occupational exposure in the geothermal industry. Anspaugh [A10] reported no evidence of increased external gamma exposure, but did note increased levels of radon and short-lived progeny at several locations normally inaccessible except during maintenance. In general, moderate to severe disequilibria were found, and an average excess amount of exposure was 0.05 Working Levels<sup>7</sup> (WL) ( $1 \mu\text{J m}^{-3}$ ). Razzano and Cei [R1] indicated that 36 persons work over three shifts to operate the Larderello complex. From data in the same paper, the electricity generated in 2013 at Larderello was 5,659 GW h with 767 MW of “efficient” installed capacity. The combination of these data leads to an annual occupational exposure of 5 man WLM/(GW a). According to [I11] 1 WLM is equivalent to an effective dose of 10–20 mSv, but the higher values are associated with mines and homes. A more reasonable value for outdoor exposure is 10 mSv, which would also be consistent with [U10]. Thus, the normalized collective dose to workers in geothermal electricity generation would be 0.05 man Sv/(GW a).

## VII. ASSESSING DOSES FROM THE CONSTRUCTION PHASE OF ELECTRICITY-GENERATING TECHNOLOGIES

162. All electricity-generating technologies considered by the Committee have a construction phase during which the facilities and infrastructure are established. Although in general there are no significant radiation exposures associated with the construction, there may be radiation exposures associated with obtaining the materials for construction such as in mining activities.

163. Industries not directly linked to electricity generation, such as mining, milling and processing of metal ores, contribute to occupational and public exposure because of the presence of natural radionuclides [U11, U22]. While public exposures from the mining industry may be negligible on an individual basis, typical occupational doses in the mining industry may be up to a few millisieverts in a year. The collective dose from occupational exposures during the mining of metals was evaluated for this study on the basis of the dose per unit mass of metal ore mined for each electricity-generating technology, as discussed in the UNSCEAR 2008 Report [U11], and on recent data from 2012 on radiation exposure of miners of rare earth metals in China [W3].

---

<sup>7</sup> A working level (WL) is a unit of potential alpha energy per unit of air. In the SI system of units, one WL is equal to  $2.08 \times 10^{-5} \text{ J m}^{-3}$ . A working level month is a unit of exposure to 1 WL for a month. For occupational personnel one month is considered to be 170 hours.

164. Aggregate is also used extensively in the construction of electricity-generating plants. Aggregate in building and construction refers to the material used for mixing with cement, bitumen, lime, gypsum and other additives to form concrete or mortar. Commonly used aggregates include sand, crushed or broken stone, gravel, and blast-furnace slag. In some cases, the amount of aggregate used is similar to the total mass of all other materials.

165. The relative volumes of concrete required to construct various nuclear and coal-fired power plants are tabulated in tables 35 and 36. Typical radionuclide concentrations in raw and processed materials and in wastes of the mineral processing industry, including the cement industry, were reviewed in the UNSCEAR 2000 Report (see table 27 in [U9]). Typical radionuclide concentrations in metal ores were reported to be about three orders of magnitude higher than of materials in the cement industry. For this assessment, only the occupational exposures from the mining of metal ores needed for metals used in construction of electricity-generating technologies were evaluated.

Table 35. Estimates of the amounts of construction materials used in nuclear power plants

<i>Plant</i>	<i>Mass of metals (t)</i>	<i>Volume of concrete (m<sup>3</sup>)</i>
PWR, 1 000 MW(e) [D5]	61 000	169 000
BWR, 1 000 MW(e) [D5]	66 000	200 000
PWR, 1 000 MW(e) [B8] <sup>a</sup>	38 000 (estimated)	75 000 (estimated)
Nuclear power plant [W5]	36 000	75 000

<sup>a</sup> The amount presented for specific metals: Al, Cr, Cu, Ag, Fe, Pb, Mg, Mn, Mo, Ni, Sn, Zn.

Table 36. Estimates of the amounts of construction materials used in coal-fired power plants

<i>Plant<sup>a</sup></i>	<i>Mass of metals (t)</i>	<i>Comments</i>	<i>Volume of concrete (m<sup>3</sup>)</i>
Coal-fired power plant [S7]	50 000 steel	Amount presented in generic terms as "steel" and expressed in kg/MW(e)	380 000
Coal-fired power plant [W5]	41 000 metals	Amount presented for specific metals: Al, Cr, Cu, Mn, Mo, Ni, steel (low alloy and stainless) and V and expressed in t/GW(e)	31 000

<sup>a</sup> 1,000 MW(e) plant assumed.

166. The mass of metal ore required to produce the metals in the building materials has been estimated from information on the total metal inventory required and from the metal ore grade used. It was assumed that steel was the primary metal used. Iron is alloyed with carbon to produce plain carbon steel. Alloy steels also contain various alloying metals. The category of steel used in the different electricity-generating technologies and the contents of alloying metals were considered. Plain carbon steels were assumed to contain iron and 0.16–0.59% carbon. Low-alloy steels were assumed to contain less than 0.25% carbon, as well as small amounts of nickel, chromium, molybdenum, manganese and silicon. High-alloy stainless steels were assumed to contain molybdenum, chromium and/or nickel and other elements. These assumptions are based on the information in [C1, G3].

167. For high-alloy stainless steel, type S316 was used as the basis for this assessment, because it is widely used in industrial applications. Type S316 contains around 2% by mass of molybdenum [A3, S3]. Other steel types may contain different levels of molybdenum, or none at all, which could influence the results. This is because molybdenum is a low-grade metal ore and therefore extraction of molybdenum may make a larger contribution to occupational exposures [A3, S3].

168. Based on the above, the composition of typical steels for each category (plain, low-alloyed and high-alloyed stainless) was assumed as shown in table 37. If the type of steel was not known, the proportions given in table 38 were assumed.

Table 37. Composition of different types of steel (based on [C1, G3])

<i>Material</i>	<i>Composition (% by weight)</i>
PLAIN STEEL	
Iron	99.62
Carbon	0.38
LOW-ALLOY STEEL	
Iron	99.63
Molybdenum	0.33
Carbon	0.05
HIGH-ALLOY STAINLESS STEEL	
Iron	65.35
Chromium	17.00
Nickel	12.00
Molybdenum	2.50
Manganese	2.00
Other non-metallic elements	1.07
Carbon	0.08

Table 38. Assumed mix of steel types used in construction where details were not specified (based on [C1, G3])

<i>Steel type</i>	<i>Proportion of total (%)</i>
High-alloy stainless steel	10
Low-alloy steel	30
Plain steel	60

169. *Assumptions on ores.* The amount of ore required for the construction of an electricity-generating facility also depends on the ore grade. The assumptions made regarding ore grades are shown in table 39 [A8, C3, M1].

Table 39. Metals and their assumed ore grades

The data presented here are typical values taken from [A8, C3, M1], and the numbers have been rounded

<i>Resource</i>	<i>Ore grade at mine (%)</i>
Tin	79
Manganese	47
Zirconium	47
Iron	46
Magnesium	41
Tantalum	31
Chromium	26
Aluminium	11
Zinc	7
Lead	6
Nickel	2
Copper	1.4
Vanadium	0.3
Molybdenum	0.18
Silver	0.01
Gold	0.0005

170. *Recycling of metals.* Recycling is an important part of the metal industry from both an economic and energy-saving point of view. In the United States, approximately two thirds of the steel produced in 2008 was made from recycled material [U15]. Around 43% of the total crude steel production worldwide is made from recycled steel, with the main sources for steel recycling typically being discarded cars, household appliances and steel cans, as well as old buildings and structures [W4]. Typical building construction uses approximately 60–65% recycled metal [B1], while in the United Kingdom about 94% of construction steel is recovered [T3].

171. Special rules apply to the re-use of scrap steel and other metals from nuclear power plants; authorities establish limits on the activity concentrations of radionuclides in materials that can be released for recycling. There is, however, no indication that there are significant differences in the degree of recycling between the various electricity-generating technologies.

172. The effect of recycling metals has not been included in the present study, because of insufficient data for large portions of the world. By not explicitly considering recycling, the collective dose per unit of electricity generated due to the extraction and processing of the metals used in the construction of a facility is likely to be overestimated by around a factor of two on average, and possibly a factor of five or more for some regions of the world with developed recycling processes. This should not affect the relative comparisons of occupational exposures from mining metals between technologies, but would affect comparisons of the total exposures (public and occupational) among the electricity-generating technologies.

173. *Dose assessment.* To estimate the radiation exposure of workers in the mining industry (occupational exposure) from ore extraction and processing, the following assumptions were made:

(a) The ores are extracted only through underground mining. The use of above-ground mining would give rise to smaller radiation doses than underground mining [U11]. Consequently, this assumption leads to an overestimation of collective dose.

(b) The presence of several metals in an ore was not considered. Each ore was assumed to contain only one metal type, and thus the contribution to occupational doses from the extraction and processing of the various minerals was evaluated independently and summed. In reality some metals will be extracted together and consequently the resulting collective doses may have been overestimated.

(c) Occupational exposures from mining and processing of raw materials were inferred from data on uranium mining and processing, and on mining other minerals. Mining data for underground copper mines in Australia (Mount Isa), Canada (Kidd Creek), South Africa (Palabora), and Portugal (Neves Corvo) show annual production rates of 1–5 kilotonnes of ore per employee [I19]. The denoted employees included all workers at the mines. Based on these data, the Committee selected a mid-range value of 3 kt of metal ore per employee for use in this assessment (table 40).

(d) The average annual effective dose to non-uranium miners, including those involved in mineral processing, given in the UNSCEAR 2008 Report [U11] was 3.0 mSv, with a range of 1.3 to 5.0 mSv. Using an annual average value of 3.0 mSv for all workers associated with the mining industry, and the value of 3 kt of metal ore per employee given in (c), the collective dose per unit mass of ore extracted was estimated at  $1 \times 10^{-9}$  man Sv/kg (table 40). The data for (c) and (d) were obtained from different worker populations and this introduces some uncertainty in the estimation of the collective dose per unit mass of ore extracted.

(e) In a recent study in China [W3] data were collected on radiation levels, and dose assessments were performed for workers of the rare earth industry in the Baotou area and Sichuan Province, two large mining districts in China. These regions account for about 77% of the total annual output of rare earth mines in China; the reported annual production rates were 0.01 and 0.02 kt of rare earth metal per mining employee, respectively.

(f) The Chinese study has estimated the collective dose per unit mass of rare earth metal extracted. The typical value for the whole rare earth industry that was obtained in the Chinese study on radiation exposure of Chinese workers in mining, crushing, beneficiation and refining is about  $150 \times 10^{-9}$  man Sv/kg. This value relates to the mass of metal extracted, which differs from the value  $1 \times 10^{-9}$  man Sv/kg given in (d) which relates to mass of metal ore. The Committee used the latter value in the analysis in order to account for the different metal requirements with associated metal ore grades of each electricity-generating technology.

(g) As a check, an alternative estimate was obtained by comparing with the data on uranium mining. The collective dose per unit mass of uranium extracted given in the UNSCEAR 2008 Report [U11] was 1 man Sv/kt (based on 2000–2002 data). Assuming (from information in [I4, O8]) an average grade for uranium ore of 0.3%, the collective dose per unit mass of uranium ore extracted is  $3 \times 10^{-9}$  man Sv/kg.

174. Although the assumptions in paragraph 173 affect the absolute values of the assessed collective dose, the relative importance of the different electricity-generating technologies with regards to the construction phase remains.

Table 40. Collective effective dose per unit mass of ore mined used in this study

<i>Estimate based on</i>	<i>Annual production rate of ore per person (kt)</i>	<i>Average annual occupational dose (mSv)</i>	<i>Collective dose per unit mass of metal ore extracted (man Sv/kg)</i>
[U11]	3	3	$1 \times 10^{-9}$

175. *Nuclear power plants.* For the current assessment, the assumed design lifetime of a nuclear power plant was 40 years and the capacity factor<sup>8</sup> was 90% (table 41).

176. Three different studies of the use of materials in nuclear power plants have been published. Dones et al. [D5] studied the material used in two Swiss nuclear power plants—the pressurized-water reactor (PWR) at Gösgen and the boiling-water reactor (BWR) at Leibstadt. Both were of the 1,000 MW(e) type, but the capacity of the Leibstadt plant was increased to 1,190 MW(e) following construction. For the latter, the total amount of metals used was 66,000 tonnes, of which two thirds were unalloyed steel/iron. In addition, 200,000 m<sup>3</sup> of concrete were used. Bryan and Dudley [B8] considered the quantities of different materials used in a typical 1,000 MW(e) PWR with river water cooling. The total mass of metals used was estimated at 38,000 tonnes but the proportions of each metal were not specified. The total amount of concrete used was estimated as 210,000 tonnes (~87,260 m<sup>3</sup>). White and Kulcinski [W5] gave the amount of material needed for four power plants, including a nuclear power plant, where values of 36,000 tonnes of metals and 180,000 tonnes (~75,000 m<sup>3</sup>) concrete were given. The study focused on the energy payback ratio<sup>9</sup> and CO<sub>2</sub> emissions, and it was not in that sense a full life cycle assessment. Furthermore, the study did not consider potential radiation exposure. The data from the three studies are presented in table 35.

Table 41. Assumed plant sizes, life times and capacity factors for the different electricity-generating technologies

\* Assumed to be the same as coal

<i>Electricity-generating technology</i>	<i>Typical plant gross capacity (MW(e))</i>	<i>Lifetime (years)</i>	<i>Capacity factor (%)</i>
Nuclear [I3]	1 000	40	90
Coal [F3, I18]	1 000	40	80
Natural gas [O1, S8]	505	25	80
Solar PV [F3, N3]	—	30	9.4
Wind turbine [D2, N4, O10]	25	20	24
Biomass [W5]	1 000*	20	75
Geothermal [R5, S9]	NA	30	NA

<sup>8</sup> Capacity factor (net) is the ratio of the net electricity generated, for the time considered, to the energy that could have been generated at continuous full-power operation during the same period [U25].

<sup>9</sup> Energy payback ratio is the ratio of total electrical energy produced during a system's normal lifespan, divided by the electrical energy required to build, maintain and fuel it.

177. *Example of a dose calculation for a nuclear power plant.* Specifications of the typical plant gross capacity, lifetimes and capacity factors (can also be called load factor) used in the calculations are shown in table 41. Table 42 shows an example of the details of a dose calculation for a nuclear power plant. The collective dose was estimated based on occupational exposures related to metal ore mining and processing of the metal ore for metals needed to construct the power plants.

Table 42. Example calculation of collective dose from occupational exposure during construction phase of a nuclear power plant

Type: PWR Gösgen, 970 MW(e), capacity factor 90% [D5]

Resource/Elements	Metal needed for construction (kg/kWh)	Ore grade at mine (%)	Amount of ore needed at mine (kg/kWh)	Collective dose (manSv/(GW a))
Stainless steel				
Iron	$4.7 \times 10^{-5}$	46	$1.0 \times 10^{-4}$	$8.9 \times 10^{-4}$
Manganese	$1.4 \times 10^{-6}$	47	$3.1 \times 10^{-6}$	$2.7 \times 10^{-5}$
Chromium	$1.2 \times 10^{-5}$	26	$4.8 \times 10^{-5}$	$4.2 \times 10^{-4}$
Molybdenum	$1.8 \times 10^{-6}$	0.18	$9.9 \times 10^{-4}$	$8.7 \times 10^{-3}$
Nickel	$8.6 \times 10^{-6}$	2	$4.3 \times 10^{-4}$	$3.8 \times 10^{-3}$
Low-alloyed				
Iron	$1.8 \times 10^{-5}$	46	$3.9 \times 10^{-5}$	$3.5 \times 10^{-4}$
Molybdenum	$5.9 \times 10^{-8}$	0.18	$3.3 \times 10^{-5}$	$2.9 \times 10^{-4}$
Unalloyed steel				
Iron	$1.1 \times 10^{-4}$	46	$2.4 \times 10^{-4}$	$2.1 \times 10^{-3}$
Other				
Copper	$4.7 \times 10^{-6}$	1.4	$3.3 \times 10^{-4}$	$2.9 \times 10^{-3}$
Aluminium	$6.3 \times 10^{-7}$	11	$5.6 \times 10^{-6}$	$4.9 \times 10^{-5}$
Total				$1.9 \times 10^{-2}$

178. *Coal-fired power plants.* There are a number of different designs of coal-fired power plants. However, the amounts of material used in their construction do not differ significantly. Spath et al. [S7] conducted a full life cycle assessment of a coal-fired power plant covering the construction and decommissioning of the plant. The amount of steel used in the construction of a 1,000 MW(e) plant was 50,000 tonnes, but no data were given on the other metals. Also, the proportions of plain carbon steel, low-alloy steel and stainless steel were not specified. White and Kulcinski [W5] described a total amount of 41,000 tonnes of metals in their study. In both studies [S7, W5], the analysed units had an assumed capacity factor of 80% and a lifetime of 40 years. The information from these studies is summarized in table 36.

179. *Natural gas power plant.* The designs of natural gas power plants also vary. Spath and Mann [S8] presented a full life cycle assessment for a 505 MW(e) natural gas power plant covering its construction and decommissioning. The study is similar in approach to the one they used for coal-fired power plants [S7]. Again, potential radiation exposure was not considered and no specific data were provided on the particular metals used to construct the plant. The amount of steel used was 31 t/MW(e) and the amount of concrete used was 98 t/MW(e). The Committee assumed that the average capacity of a natural gas

power plant was 505 MW(e) to estimate the amount of each metal using the assumptions shown in table 37 and table 38.

180. *Solar energy power plant.* Solar energy is by far the largest energy resource available on earth. Two different technologies contribute to solar electricity generation: solar photovoltaics (PV) and concentrating solar power (CSP).

181. Solar PV systems convert direct and diffused solar radiation into electricity through a photovoltaic process using semiconductor devices. Solar PV systems can be used anywhere in the world on suitable land and on buildings. Solar PV technology is also very adaptable to being used in a modular fashion, which means that systems can be installed close to centres of demand.

182. Silicon-based PV solar cells contain small amounts of rare earth elements. Crystalline-silicon PV cells are the most common PV cells in use today [U14].

183. Concentrating solar power (CSP) systems are designed to produce high-temperature heat for electricity generation or for co-generation of electricity and heat. CSP systems are capable only of exploiting direct normal irradiation, which is the energy received directly from the sun (i.e. not scattered by the atmosphere) on a surface tracked perpendicular to the sun's rays. Areas suitable for CSP development are those with strong sunshine and clear skies, usually arid or semi-arid areas. Parabolic mirrors or troughs are used in CSP<sup>10</sup> technology. The parabolic mirrors are designed to concentrate solar radiation onto linear heat collection elements [N2].

184. A solar energy power plant does not have a fuel cycle in the same way that most other energy technologies do, consequently any potential human exposure to ionizing radiation is related to the use of natural resources for manufacturing the centralized CSP plants or the PV solar cells. The largest contribution to the collective dose is from the acquisition of raw materials, especially minerals used for manufacturing the CSP plants or PV solar cells.

185. Silicon-based PV solar cells contain small amounts of rare earth elements, which are of particular interest because the ores from which they are obtained have relatively high contents of uranium and thorium. Thus, the mining of the ores and their subsequent processing lead to occupational radiation exposures.

186. Because relevant data on the use of metals and other natural resources were only readily available for the PV solar systems, the assessment was only carried out for this type of solar energy production.

187. The metals required to construct a solar PV system and amount of ore required are shown in table 43. The results are based on data for a life cycle assessment of a 3 kWp<sup>11</sup> multicrystalline-silicon PV solar panel mounted on a slanted roof in Switzerland [J1]. The solar panel efficiency was 9.4%. The solar PV system lifetime was assumed to be 30 years, with the exception of the power inverter that changes direct current to alternating current. In this case a lifetime of 15 years was assumed. The parts included were mainly PV panels, mounting structures, inverter and electric installations. Metals used for the solar panels included small amounts of rare earth elements, which are derived from ores with high contents of thorium or uranium.

188. The amount of ore required per unit of electricity generated depends on the ore grade. In table 43, the values were based on published ore grades [A8, C3, J1].

<sup>10</sup> Also called concentrated solar power and concentrated solar thermal (CST).

<sup>11</sup> The symbol, kWp, stands for the peak power (kW) of the solar PV system—the basic unit for the characterization of the capacity of PV plants measured in a standardized test at a temperature of 25 °C and an irradiation of 1,000 W/m<sup>2</sup>.



Table 43. Ore usage at mine for the production of energy by a PV solar system mounted on a slanted roof in Switzerland

Figures are for production of 1 kWh by a 3 kWp<sup>a</sup> PV solar system; ore grade values provided in table 38

Resource	Amount of metals required per unit electricity produced <sup>b</sup> (kg/kWh)	Amount of ore required per unit electricity produced (kg/kWh)
Aluminium	$1.7 \times 10^{-3}$	$1.5 \times 10^{-2}$
Chromium	$2.6 \times 10^{-6}$	$1.0 \times 10^{-5}$
Copper	$4.2 \times 10^{-4}$	$3.0 \times 10^{-2}$
Iron	$1.3 \times 10^{-3}$	$2.7 \times 10^{-3}$
Lead	$1.3 \times 10^{-6}$	$2.2 \times 10^{-5}$
Magnesium	$5.4 \times 10^{-5}$	—
Manganese	$4.4 \times 10^{-6}$	$9.3 \times 10^{-6}$
Molybdenum	$4.2 \times 10^{-6}$	$8.3 \times 10^{-3}$
Nickel	$5.0 \times 10^{-8}$	$2.5 \times 10^{-6}$
Silver	$2.9 \times 10^{-6}$	$2.9 \times 10^{-2}$
Tantalum	$7.8 \times 10^{-7}$	$2.5 \times 10^{-6}$
Tin	$1.6 \times 10^{-6}$	$2.1 \times 10^{-6}$
Zinc	$3.1 \times 10^{-6}$	$4.4 \times 10^{-5}$

<sup>a</sup> The symbol, kWp, stands for the peak power (kW) of the solar PV system—the basic unit for the characterization of the capacity of PV plants measured in a standardized test at a temperature of 25 °C and an irradiation of 1,000 W/m<sup>2</sup>.

<sup>b</sup> Calculated based on data in Jungbluth et al. [J1].

189. *Wind power plant.* The kinetic energy of wind is exploited in wind turbines for electricity generation. Wind speeds suitable for electricity generation range from 4 to 25 metres per second. These are attainable practically all over the world, with the exception of some equatorial regions. Wind power is exploited not only onshore but also offshore, where wind speeds are higher and the wind is typically available more regularly and for longer periods of time. The depth of water and distance from centres of demand onshore are major factors influencing the siting of offshore developments [O3].

190. An assessment of materials used to build an onshore wind power unit was conducted by White and Kulcinski [W5]. The assessment was for a three-blade wind turbine and assumed a 25 MW(e) unit, with a capacity factor of 24% and a lifetime of 20 years. The data on construction materials is summarized in table 44.

Table 44. Estimates of the amounts of construction materials used in wind power plants

Data in White and Kulcinski [W5] and references therein. Amount presented is for low-alloy and stainless steel and expressed in t/GW(e)

Plant <sup>a</sup>	Mass of metals (t)	Volume of concrete (m <sup>3</sup> )
Wind power plant [S7]	85 000 steel	130 000

<sup>a</sup> 25 MW(e) plant assumed.

191. *Biomass power plant.* Biomass fuel includes straw, wood or wood residues from forests, and wood waste from wood-processing plants, such as sawmills or pulp and paper mills. Biomass fuel can contain varying amounts of radionuclides associated with past emissions or accidents. One example of this is fuel containing varying amounts of  $^{137}\text{Cs}$  in wood that has been obtained from forested regions affected by fallout from past nuclear power plant accidents. The  $^{137}\text{Cs}$  can be emitted in the flue gases or concentrated in the ash from the combustion of biomass containing  $^{137}\text{Cs}$  and possibly lead to exposures. In some areas filters are currently in use to decrease the  $^{137}\text{Cs}$  in the flue gases, and treatment or proper burial of the ashes can reduce or prevent exposures. Exposures via these pathways are not treated further here since the  $^{137}\text{Cs}$  originates from nuclear power plant accidents and are concentrated in the forested areas that have received significant fallout from past accidents.

192. In general terms, biomass fuel has a lower energy density than coal and is more challenging to handle. As a consequence, the fuel handling equipment is heavier than that for a coal-fired power plant of equivalent capacity. Technically, biomass power plants can be as large as coal-fired power plants in terms of installed capacity, but, in general, biomass units are not built as large as coal units, mostly because of the significant difficulties with supply and storage associated with materials of lower energy density [R2].

193. The design of a biomass power plant is not very different from that of a coal-fired power plant. The main difference is that the ash handling equipment is generally smaller in a biomass plant, depending on the type of fuel used (biomass typically generates less ash than coal). However, this difference may be neglected to a first approximation, and therefore the Committee assumed that the materials required per kilowatt to build a biomass power plant were the same as those given by White and Kulcinski for a coal-fired power plant [W5]. For the biomass power plant, the capacity factor was assumed to be 75% and plant lifetime 20 years.

194. *Summary.* Table 45 shows occupational collective effective doses normalized to energy production due to mining for ores and the processing needed for construction of the electricity-generating plants or devices, as estimated in this study. Electricity-generating technologies using coal, natural gas and biomass have the lowest collective doses normalized to electricity generated, followed by slightly higher values for nuclear power. Wind power shows a larger collective dose by about a factor of 10 compared to the lowest values, and solar power shows the largest value by about a factor of 80. The differences between the various electricity-generating technologies are connected to various plant facilities using different types and amounts of steel and metals. Another reason is the differences in the capacity factors and lifetime of the plants, with a higher capacity factor and longer lifetime implying a lower collective dose per unit of electricity generation.

Table 45. Collective effective dose normalized to unit of electricity generation for construction of electricity-generating plants or devices

<i>Electricity-generating technology</i>	<i>Normalized occupational collective dose due to mining and processing of ores needed for construction (manSv/(GW a))</i>
Nuclear	0.02
Coal	0.01
Natural gas	0.01
Solar PV	0.8
Wind	0.1
Biomass	0.01

## VIII. COMPARISON OF RADIATION EXPOSURES FROM ELECTRICITY-GENERATING TECHNOLOGIES

195. Sources of radiation exposure from electricity-generating technologies based on the (a) nuclear fuel cycle, (b) coal cycle, the combustion of natural gas, oil and biofuels, (c) geothermal energy, (d) wind power and (e) solar energy have been investigated in this annex. Two electricity-generating technologies, the nuclear fuel cycle and the coal cycle have been substantially investigated using the same methodology, the Committee's revised methodology for estimating public exposures due to radioactive discharges (annex A). This same methodology was also used to investigate public exposures derived with more rudimentary assessments based on less available data for the electricity-generating technologies that employ combustion of oil and natural gas, and geothermal energy.

196. Occupational exposures for all of these technologies were also estimated, relying mainly on data from dosimetric records of worker exposures. In addition, new assessments on occupational exposures from (a) decommissioning of nuclear power reactors and (b) the mining of rare earth metals needed for the construction phase in different electricity-generating technologies have been presented, adding for the first time solar energy, wind power and combustion of biomass to the electricity-generating technologies assessed by the Committee.

197. This chapter compares the results for the different electricity-generating technologies investigated by applying the revised methodology for estimating public exposures due to radioactive discharges (annex A). This is followed by a comparison of all results for both occupational and public exposures.

### A. Comparison of public exposures due to radioactive discharges from the electricity-generating technologies based on the nuclear fuel cycle, coal cycle, combustion of natural gas and oil, and use of geothermal energy

198. Table 46 shows results from applying the revised methodology for estimating public exposures due to radioactive discharges (annex A). The results represent the sum of all discharges assessed in this annex for the electricity-generating technologies based on the (a) nuclear fuel cycle, (b) coal cycle and combustion of natural gas and oil, and (c) use of geothermal energy.

199. The table provides estimates of collective doses to the worldwide public, and associated collective doses normalized to electricity generation in 2010, integrated to 100 years. Collective doses normalized to electricity generation are the sum of the collective doses for each process in the nuclear fuel cycle, or the coal cycle, divided by the total electricity generated in 2010 for that cycle. For the coal cycle, the doses were estimated assuming all discharges were either from older coal plants or from modern ones. Both results are shown and represent a range of values for the coal cycle. Although the assessments of the nuclear fuel cycle and coal cycle were more substantive than those for the combustion of oil and natural gas, and geothermal energy, the Committee considered that comparing the magnitudes of the total and normalized collective doses was still valid.

Table 46. Collective dose to the worldwide public, and associated normalized collective dose for 2010, integrated to 100 years<sup>a,b</sup>

Except where otherwise specified, the collective doses given are for the local and regional components. Shown also is the percentage of total world electricity generation in 2010 for each electricity-generating technology and the discharges for <sup>222</sup>Rn normalized to the electricity generation in 2010

<i>Electricity-generating technology</i>	<i>Collective dose (man Sv)</i>	<i>Normalized collective dose (man Sv/(GW a))</i>	<i>% of total world electricity generation in 2010</i>	<i>Normalized <sup>222</sup>Rn discharges (TBq/(GW a))</i>
NUCLEAR FUEL CYCLE				
Nuclear, total from mining and milling, power plants and reprocessing, excluding global component	130	0.43	13	Uranium mining – 66 Milling – 3 Operational mill tailings – 3 Mill tailings <sup>c</sup> – 10
Adding global component integrated to				
100 years	910	3.0		
500 years	1 700	5.5		
10,000 years	7 600	25		
COAL CYCLE				
Coal, older coal plants	1 400	1.4	40	Coal mining – 2.8
Coal, modern coal plants	670	0.7		Power plants – 0.07 Ash <sup>c</sup> – 1.8
OTHERS				
Natural gas	55	0.10	22	0.75
Oil	0.03	0.000 3	4.6	0.002
Geothermal (low-density population – default population)	5–160	1–20	0.3	150

<sup>a</sup> Projections of any health effects using collective doses in the table are not recommended.

<sup>b</sup> All estimates are calculated based on best estimates; site- and location-specific collective doses are not presented.

<sup>c</sup> The values of the normalized <sup>222</sup>Rn discharges (TBq/(GW a)) shown in table 46 for uranium mine mill tailings (Mill tailings) and for coal ash deposits (Ash) were multiplied by 100 to account for radon emanating for 100 years from these surfaces. The value for coal ash deposits was also multiplied by a factor of 0.6 since only 60% of the ashes produced are deposited.

200. Excluding the global component from the globally-circulating nuclides, electricity generation from the coal cycle gave the highest collective dose to the public integrated to 100 years—both for the total generation in 2010 and when normalized to unit of electricity generated—for both older and modern coal plants. When the global component resulting from the globally-circulating radionuclides originating from the nuclear fuel cycle was taken into account, integrated to 100 years, the total collective dose from the nuclear fuel cycle was of the same order as from the coal cycle, about in the middle range of the values for modern versus older coal plants. Because of ongoing global exposures from the globally-circulating radionuclide <sup>14</sup>C discharged from nuclear power plants and from

reprocessing facilities, the collective dose from the nuclear fuel cycle slowly increases over centuries as shown in figure V, in section IV. This is also evident in the doses shown in table 46 for the global circulation integrated to 100, 500 and 10,000 years. The total collective dose normalized to electricity generated for the nuclear fuel cycle, including the globally-circulating nuclides and integrated to 10,000 years, is 25 man Sv/(GW a) as shown in table 46. Comparing with earlier UNSCEAR assessments, the UNSCEAR 2000 Report [U9] estimated the same quantity as 40 man Sv/(GW a). As described earlier, the collective dose from globally-circulating radionuclides is the sum of very small doses to the entire world's population. The local and regional components of collective dose assessed for the nuclear fuel cycle excluding globally-circulating radionuclides, and for the coal cycle, are for the local and regional populations exposed to the respective discharges of the source (see paragraph 34).

201. The magnitude of collective doses resulting from the coal cycle, for both the older and the modern coal plants, is due in large part to (a) the amount of electricity generated from coal (40% of the world's electricity generation in 2010), (b) the greater number of coal mines compared to uranium mines and (c) the contribution to the collective dose from the discharge of radon and other radionuclides from the  $^{238}\text{U}$  series arising from the combustion of coal at the power plants. Another important factor is that a larger population base lives near coal plants and coal mines compared to nuclear plants and uranium mines.

202. Natural gas accounted for 22% of the world's electricity generation in 2010, which led to a larger contribution to the collective dose than oil, but was still small in relation to coal. Combustion of oil for electricity generation contributed only marginally to collective doses. These relatively small doses from natural gas and oil combustion were however the dominant contribution to collective dose for West Asia where, as shown in table 2, natural gas and oil accounted for most of the electricity generation in that region in 2010.

203. Discharges of  $^{222}\text{Rn}$  normalized to the electricity generated are also shown in table 46; the largest value is estimated for geothermal energy. This finding is based on few existing data. However, because of the process for generating electricity from geothermal energy discussed in section VI, it is reasonable that the impact of  $^{222}\text{Rn}$  discharges from gases vented during the operation of geothermal electricity-producing plants is relatively significant. The resulting doses from geothermal energy shown in table 46 are assessed using two different population densities, low-density and the default population density (see chapter III), where the available population data discussed in chapter VI suggest the low-density population distribution may be more realistic. The range in results for the collective dose demonstrates the strong dependence on the population data. However, the impact of geothermal electricity generation remains small because of the limited use of this technology.

204. The next largest value for the normalized  $^{222}\text{Rn}$  discharge is for uranium mining, which is a factor of about 20 larger than the value for coal mining. This is also reasonable because uranium mining occurs where there are high levels of uranium and therefore of its progeny products such as  $^{222}\text{Rn}$ . Shown in table 47 is a comparison of estimated doses to the public from the mining of coal and the mining of uranium. The assessments resulted in a larger estimate for the characteristic individual dose per unit of electricity generated for uranium mining (non-ISL) than for coal mining, consistent with the larger normalized  $^{222}\text{Rn}$  discharge. However, values for both the worldwide collective dose (essentially comprising local and regional components alone) and of the associated values normalized to unit of electricity generated in 2010 are larger for coal mining than uranium mining. This is because of the larger number of coal mines in the world and because the population density is higher around coal mines compared to uranium mines.

Table 47. Comparison of doses to the public from mining of coal and mining of uranium

	Coal mining	Uranium mining	
		non-ISL	ISL
Characteristic individual dose per unit of electricity generated (Sv/(GW a))	$2.4 \times 10^{-7}$	$5.5 \times 10^{-6}$	$2.5 \times 10^{-7}$
Worldwide collective dose (man Sv)	$3.7 \times 10^2$	$4.0 \times 10^1$	$1.3 \times 10^0$
World-average collective dose per unit of electricity generated (man Sv/(GW a))	$3.8 \times 10^{-1}$	$2.8 \times 10^{-1}$	$1.3 \times 10^{-2}$

205. Figure VIII shows graphically the contribution each electricity-generating technology considered makes to the worldwide collective dose to the public. Two distinct values are presented for the nuclear fuel cycle: the first is the local and regional component for the population exposed directly to the discharges, and the second includes the global component for the population of the world as a whole due to globally circulating radionuclides. The values for both the coal cycle and geothermal energy are deemed to represent boundary values, assuming either all modern or all older coal plants for the coal cycle, and for geothermal energy assuming two different population distributions. Figure IX shows the same sources as figure VIII but for the total collective dose normalized to electricity generated. The values for the nuclear fuel cycle without global circulation are slightly less than for the coal cycle, which lies somewhere between the two values given for the modern and older coal plants. Including the global circulation to the nuclear fuel cycle results in the larger value for these two technologies. Comparing these data with figure VIII shows how the magnitude of electricity generated for each technology results in the collective dose to the public. Figure IX also shows the magnitude of the upper bound for the collective dose normalized to electricity generation for geothermal energy.

206. Table 48 breaks down the comparison of collective doses—and collective doses normalized to electricity generated in 2010—for each of the source components of the nuclear fuel cycle and coal cycle technologies that have been assessed. These components are coal mining, discharges from coal combustion during power plant operation and from coal ash deposits associated with the coal cycle for electricity generation. For the nuclear fuel cycle, these components are uranium mining and milling including mill tailings, discharges during electricity generation from the nuclear power plant and discharges from reprocessing. Collective doses normalized to electricity generated in 2010 for each of the source components for the nuclear fuel cycle shown in table 48 use the electricity produced as a result of each process in the normalizations.

207. Although the differences in collective doses normalized to electricity generation for the various sources are not very large, (with the exception of old-style coal plants, which have the largest value), the total collective doses in 2010 show significant differences. For both sets of results, the largest values are from old-style coal combustion power plants. Collective doses for the different components associated with the coal cycle are all larger than collective doses for the components associated with the nuclear fuel cycle, except for modern coal plants compared to nuclear power plants. The categories shown in table 48 make clear the importance of radon discharges from coal mining and from coal ash deposits, which—with the assumptions made in this study—make significant contributions to the total collective doses even when the coal combustion power plant is modern. The differences in the dose values for the old-style compared with the modern coal combustion power plant are due to the nuclides in the  $^{238}\text{U}$  decay chain other than radon, because the radon discharge from the flue-gas stack is the same in both cases. Table 49 shows this difference between modern versus old-style coal combustion power plants regarding dose contribution per radionuclide from the  $^{238}\text{U}$  decay chain.

208. Table 49 shows local and regional components of collective doses assessed from discharges of radionuclides in the  $^{238}\text{U}$  decay chain from the flue-gas stack of a coal plant during the combustion of coal for electricity generation in a modern compared to an old-style coal plant. The  $^{222}\text{Rn}$  discharges are the same for both types of coal plant; consequently the doses from  $^{222}\text{Rn}$  are also the same in table 49. It is clear from the breakdown of the radionuclides shown in table 49 that the large differences in the doses assessed for the old-style versus modern coal plants are due to the other radionuclides shown, with  $^{210}\text{Pb}$  and  $^{210}\text{Po}$  giving the largest contribution.

Figure VIII. Local and regional components of the collective doses to the public integrated to 100 years, for the electricity-generating technologies based on the nuclear fuel cycle, coal cycle, combustion of gas and use of geothermal energy

Data from table 46

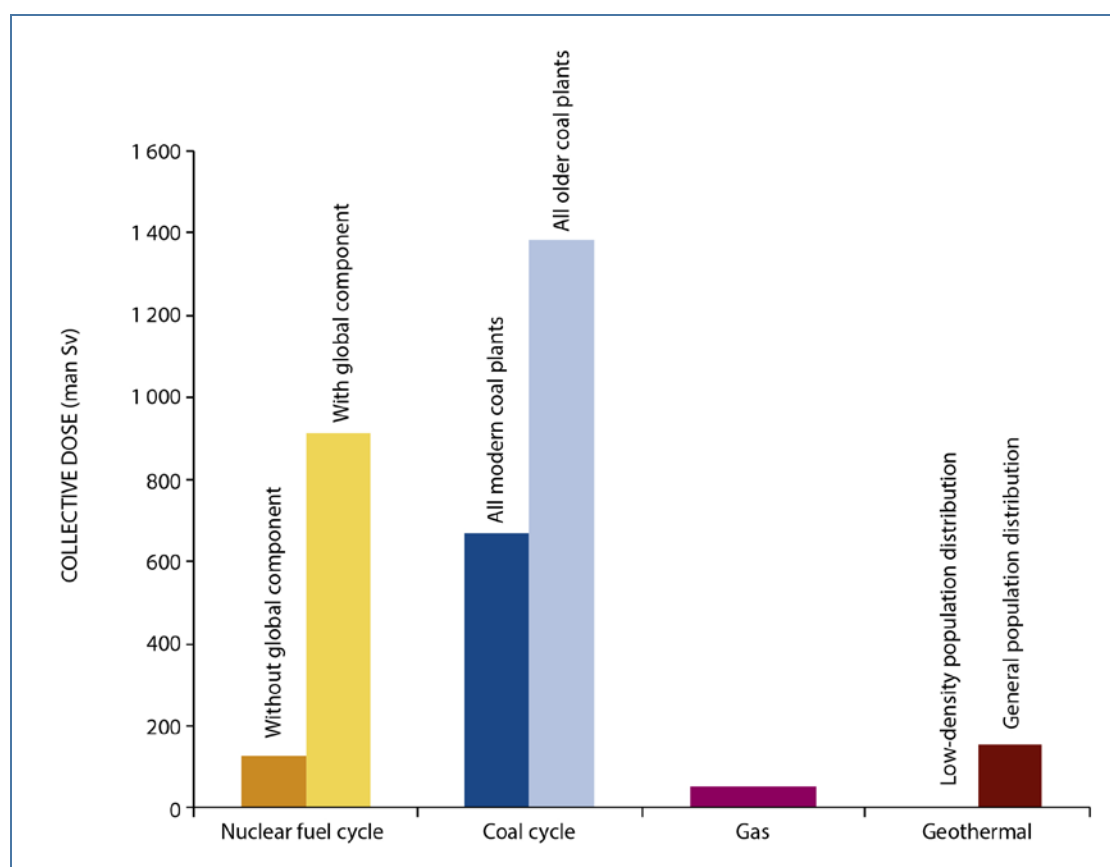

Figure IX. Local and regional collective doses to the public integrated to 100 years, normalized to electricity generated for the technologies based on the nuclear fuel cycle, coal cycle, combustion of gas and use of geothermal energy

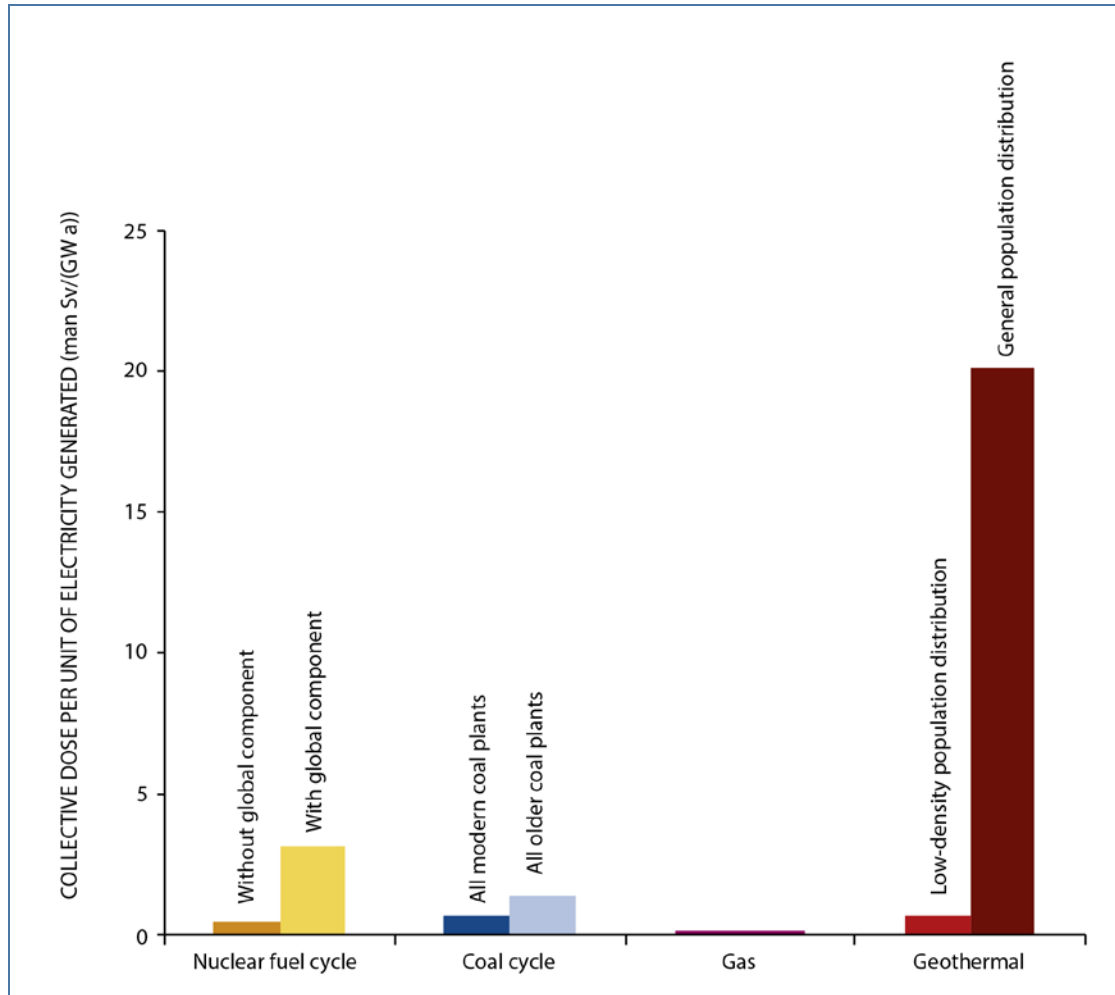

Table 48. Comparison of collective doses to the public, and collective doses normalized to electricity generation in 2010, integrated to 100 years, to the world-average population within a 1,500 km radius of each source for the electricity-generating technologies based on the coal cycle and the nuclear fuel cycle

Coal			Nuclear		
Source	Collective dose (man Sv)	Normalized collective dose (man Sv/(GW a))	Source	Collective dose (man Sv)	Normalized collective dose (man Sv/(GW a))
Coal mining	370	0.4	Uranium mining <sup>a</sup> and milling	53	0.2
Older coal plants	780	0.8	NPP generation	68	0.2
Modern coal plants	60	0.1	Reprocessing	7.6	0.03
From coal ash deposits	240	0.2			

<sup>a</sup> Of the 53 man Sv for uranium mining and milling, 40 man Sv is from mining only.



Table 49. Local and regional components of collective dose, integrated to 100 years, due to discharges from modern and old-style coal combustion power plants

Radionuclide	Collective dose from modern coal plants (man Sv)		Collective dose from old-style coal plants (man Sv)	
	Local	Regional	Local	Regional
<sup>210</sup> Pb	2	9	28	135
<sup>210</sup> Po	3	14	46	216
<sup>222</sup> Rn	2	8	2	8
<sup>226</sup> Ra	1	7	20	98
<sup>230</sup> Th	2	8	26	122
<sup>234</sup> U	0.5	2	7	34
<sup>238</sup> U	0.4	2	6	29
Total <sup>a</sup>	11	50	135	641

<sup>a</sup> Slight differences between the totals shown here and those in table 48 are due to rounding performed on the values in table 48. The values in table 49 are left as generated in the assessment to avoid inconsistent rounding of individual radionuclides for the purpose of attaining the same total rounded value as shown in table 48. It should also be recalled that in this table, as in all tables in the annex resulting from assessments, the calculations are done to full precision and any discrepancies in the final sum of numbers in the tables are due to rounding.

209. Doses assessed from the radon emanation from coal ash versus uranium mill tailings, using <sup>222</sup>Rn discharges normalized to electricity generated given in table 46, are compared in table 50. As described in chapter IV and more extensively in annex A, a low population density was used in the assessments on uranium mill tailings whereas a default population density was used in the assessment on coal ash. The characteristic individual dose per unit of electricity generated is larger for uranium mill tailings compared to coal ash, reflecting the greater activity concentrations of naturally occurring radionuclides, including radon, in mill tailings. However, when the total electricity generation is taken into account, collective doses assessed from coal ash are greater than those from mill tailings. The results show the effect of the continued emanation of radon centuries into the future.

Table 50. Collective dose per unit of electricity generated to world-average population within 1,500 km and integrated to 100 years, also integrated for two different times since disposal, and characteristic individual dose per unit of electricity generated from emanation of radon from coal ash and mill tailings

Time since disposal	Collective dose per unit of electricity generated (man Sv/(GW a))		Characteristic individual dose per unit of electricity generated (Sv/(GW a))	
	Coal ash	Mill tailings	Coal ash	Mill tailings
100 years	0.2	0.04	$1.5 \times 10^{-7}$	$8.4 \times 10^{-7}$
500 years	1.2	0.2		

210. Significant radionuclides from nuclear power plant discharges. The importance of <sup>14</sup>C and the globally circulating radionuclides, and <sup>222</sup>Rn and the <sup>238</sup>U series, is discussed in other sections. The following concentrates on comparing other significant radionuclides discharged from different nuclear power plant types.

211. Table 51 shows the world-average collective dose per unit of electricity generated for the nuclear power plant types assessed in this annex. The table illustrates the relative importance to the world-average collective dose per unit of electricity generated of  $^{90}\text{Sr}$ ,  $^{137}\text{Cs}$  and  $^3\text{H}$  from the GCR-type reactor, and tritium from the HWR reactor.

Table 51. Local and regional components of collective doses, integrated to 100 years, normalized to electricity generation in 2010, shown for all nuclear power plant types considered

See chapter IV for details on the power plant types

Discharged radionuclide	World-average collective dose per unit of electricity generated for each nuclear power plant type (man Sv/(GW a))						
	PWR	BWR	HWR	LWGR	AGR	GCR	FBR
$^3\text{H}$	$7.2 \times 10^{-2}$	$8.6 \times 10^{-3}$	$1.7 \times 10^0$	$1.2 \times 10^{-1}$	$1.9 \times 10^{-2}$	$3.3 \times 10^{-2}$	$2.3 \times 10^{-1}$
$^{14}\text{C}$	$4.6 \times 10^{-2}$	$3.2 \times 10^{-2}$	$1.4 \times 10^{-1}$	$3.1 \times 10^{-1}$	$3.5 \times 10^{-1}$	$1.3 \times 10^0$	$2.8 \times 10^{-2}$
$^{35}\text{S}$	0	0	0	0	$4.5 \times 10^{-2}$	$2.4 \times 10^{-1}$	0
$^{41}\text{Ar}$	$4.5 \times 10^{-5}$	$4.6 \times 10^{-5}$	$1.3 \times 10^{-3}$	$3.4 \times 10^{-3}$	$8.4 \times 10^{-4}$	$7.0 \times 10^{-2}$	0
$^{54}\text{Mn}$	$2.3 \times 10^{-5}$	$1.0 \times 10^{-4}$	0	$4.0 \times 10^{-5}$	0	0	$1.8 \times 10^{-4}$
$^{58}\text{Co}$	$3.7 \times 10^{-5}$	$4.0 \times 10^{-5}$	0	$5.9 \times 10^{-6}$	0	0	$1.7 \times 10^{-4}$
$^{60}\text{Co}$	$2.0 \times 10^{-4}$	$5.6 \times 10^{-3}$	$1.5 \times 10^{-4}$	$8.8 \times 10^{-3}$	$7.0 \times 10^{-2}$	$3.5 \times 10^{-3}$	$2.3 \times 10^{-3}$
$^{65}\text{Zn}$	0	$5.0 \times 10^{-4}$	0	$1.6 \times 10^{-4}$	$7.0 \times 10^{-5}$	0	0
$^{85}\text{Kr}$	$2.2 \times 10^{-6}$	$1.4 \times 10^{-5}$	0	0	0	0	$1.7 \times 10^{-4}$
$^{90}\text{Sr}$	$7.0 \times 10^{-5}$	$1.2 \times 10^{-3}$	0	$1.2 \times 10^{-2}$	$3.4 \times 10^{-5}$	$4.7 \times 10^{-1}$	0
$^{106}\text{Ru}$	$3.7 \times 10^{-5}$	$1.0 \times 10^{-6}$	0	0	0	0	0
$^{131}\text{I}$	$6.0 \times 10^{-5}$	$3.2 \times 10^{-4}$	$1.7 \times 10^{-5}$	$7.5 \times 10^{-3}$	$2.5 \times 10^{-5}$	0	$1.5 \times 10^{-4}$
$^{133}\text{Xe}$	$1.2 \times 10^{-4}$	$1.5 \times 10^{-4}$	0	$1.1 \times 10^{-2}$	0	0	0
$^{135}\text{Xe}$	$3.4 \times 10^{-5}$	$3.4 \times 10^{-4}$	0	$2.4 \times 10^{-3}$	0	0	0
$^{138}\text{Xe}$	$1.5 \times 10^{-9}$	$3.1 \times 10^{-7}$	0	$1.1 \times 10^{-6}$	0	0	0
$^{134}\text{Cs}$	$3.2 \times 10^{-4}$	$2.6 \times 10^{-4}$	0	$3.4 \times 10^{-4}$	$7.4 \times 10^{-4}$	$3.8 \times 10^{-2}$	$1.1 \times 10^{-2}$
$^{137}\text{Cs}$	$4.2 \times 10^{-4}$	$1.0 \times 10^{-3}$	$4.6 \times 10^{-2}$	$6.6 \times 10^{-3}$	$6.6 \times 10^{-4}$	$6.2 \times 10^{-1}$	$7.7 \times 10^{-3}$
Total	$1.2 \times 10^{-1}$	$5.0 \times 10^{-2}$	$1.9 \times 10^0$	$4.8 \times 10^{-1}$	$4.9 \times 10^{-1}$	$2.8 \times 10^0$	$2.8 \times 10^{-1}$

212. Figure X shows estimated collective doses by world region and totalled for the world by nuclear reactor type, with the values taken from table 51. Both collective doses, and collective doses normalized to electricity generated in 2010 are shown. The collective doses show a different profile than that shown in the figure displaying the collective doses normalized to electricity generated. Two nuclear power plant types, GCRs and HWRs, dominate the collective doses normalized to electricity generated. However it is the power plant types PWRs and HWRs that dominate the contribution to the collective doses; this is because of a combination of the number of reactors that exist in each region coupled with the discharged amounts of significant radionuclides for each reactor type.

Figure X. Local and regional collective doses to the public integrated to 100 years, and associated values normalized to electricity generation, by world region and nuclear reactor type

Results shown for collective doses from all discharges (man Sv) and for collective dose from all discharges normalized to electricity generation (man Sv/(GW a)) in 2010. Note that the order of the individual reactor types is according to their world share of electricity generated in 2010, as shown in table 9

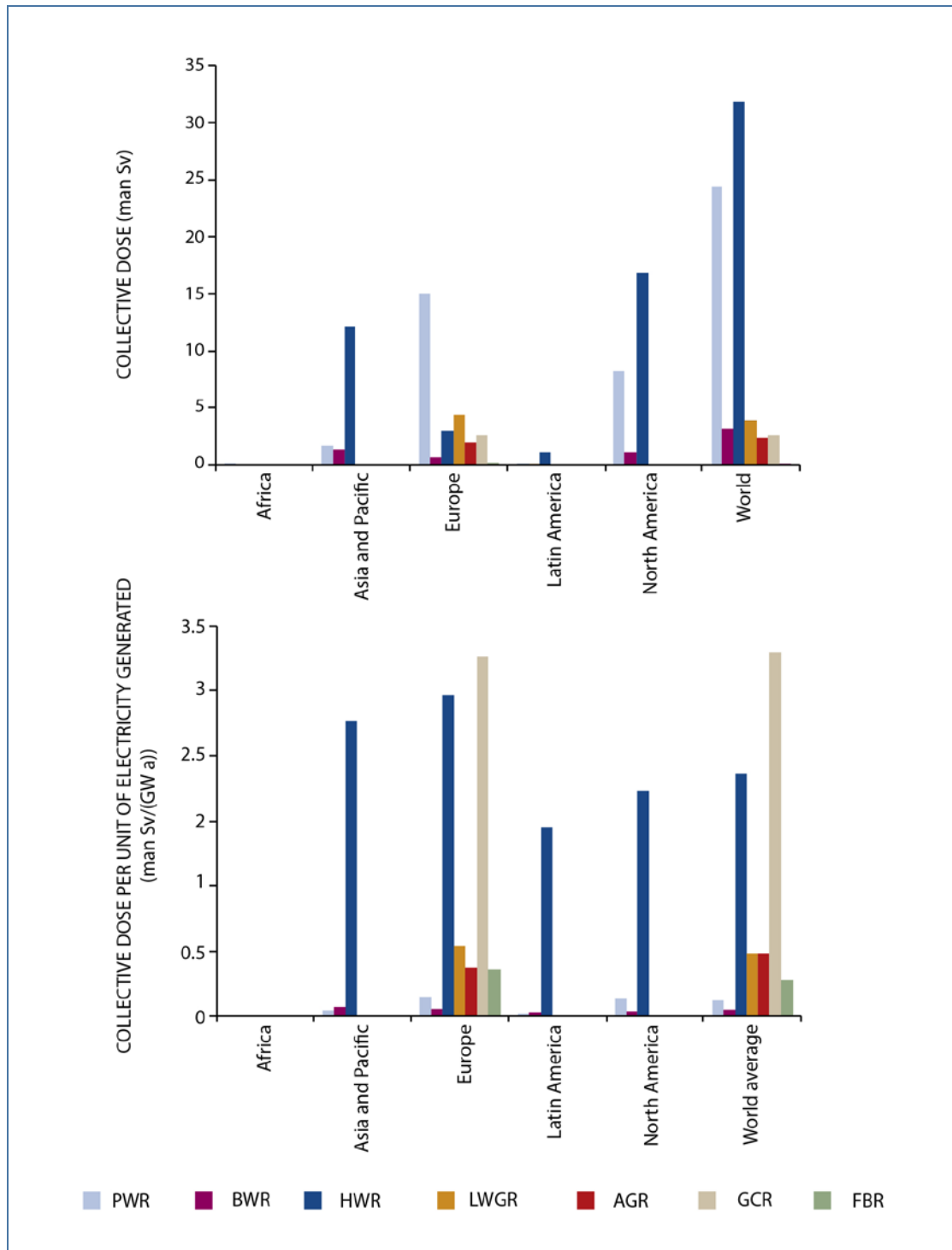

## B. Comparison of public and occupational exposures

213. Table 52 summarizes the results from all occupational and public exposures that have been presented in this annex. The table shows collective doses normalized to electricity generated in 2010, followed by collective doses for the same year. The local and regional components of doses to the public are for world-average populations out to 100 km and between 100 km and 1,500 km from a facility respectively, integrated over 100 years. Other conditions are as stated earlier in this chapter. This section considers the total exposure from each electricity-generating technology, i.e. public plus occupational exposures.

214. The occupational exposures from coal mining dominate collective doses, so that the total exposure of the public and occupational exposures combined is largest from the coal cycle. This is true even considering the public exposures from the nuclear fuel cycle including the global circulation integrated out to 10,000 years. The next largest is the total exposure from the nuclear fuel cycle, where public exposure including global circulation gives the highest dose followed by occupational exposures. The same trend is observed for the associated collective doses normalized to electricity generated, with the exception of the public exposures from the nuclear fuel cycle normalized to electricity generated integrated out to 10,000 years, which gave the largest value.

215. The comparisons of public doses shown in table 52 that have been assessed using the revised methodology for estimating public exposures due to radioactive discharges (annex A) have been described in section A of this chapter. They are provided in this table to facilitate comparison with occupational exposures and view the entire exposure, public and occupational, from each electricity-generating technology. One comparison of interest noticeable in table 52 is that collective doses to the public resulting from radon discharges from natural gas power plants are about the same as collective doses to the public resulting from the discharges from operation of nuclear power plants (55 versus 68 man Sv, respectively). However, the collective dose to the public normalized to electricity generated in 2010 is about a factor of four larger for the nuclear fuel cycle than for the combustion of natural gas (not including global circulation). The relatively large actual collective dose assessed for combustion of natural gas results from the larger amount of electricity produced by natural gas than nuclear power in 2010.

216. The assessments on collective dose provided in the annex can be put in perspective by considering natural exposure to background radiation from  $^{222}\text{Rn}$ . All doses to the public from natural gas, oil, and geothermal energy are calculated from the release of  $^{222}\text{Rn}$ . A significant fraction of the doses from the coal and nuclear cycles are also due to the release of  $^{222}\text{Rn}$ . Radon-222 occurs naturally in nature and is a major fraction of the dose to man from all naturally occurring sources of radiation. Wilkening et al. [W7] have estimated that the average exhalation rate of  $^{222}\text{Rn}$  from soil is  $1.6 \times 10^{-2} \text{ Bq (m}^2 \text{ s)}^{-1}$ . As a result of this exhalation from soil and the additional exhalation of  $^{222}\text{Rn}$  from building materials, the Committee [U9] has previously estimated that the average effective dose from  $^{222}\text{Rn}$  is  $1.15 \text{ mSv a}^{-1}$ . For the world population considered here, the collective dose due to exposure to naturally occurring radon is  $11,500,000 \text{ man Sv a}^{-1}$ , a value much larger than any given in table 46.

217. Total occupational collective doses are significantly greater than public collective doses for the coal cycle and combustion of oil, from a factor of about ten for coal plants to about five hundred for combustion of oil, although the values for combustion of oil are in comparison small. For natural gas and geothermal energy, total public collective doses were assessed to be larger than total occupational collective doses. Total occupational collective doses for the nuclear fuel cycle are of about the same order as the total collective dose to the public when including the global circulation to 100 years.

218. The largest occupational collective dose normalized to energy generated in 2010 resulting from the mining for metals for construction materials was from solar photovoltaic (PV) technology, which was a factor of forty and eighty larger than for the nuclear fuel cycle and coal cycle, respectively. This was followed by the occupational collective dose for wind power, which was also larger than the values for the nuclear fuel cycle and coal cycle. These differences come from the different metal requirements for solar PV and wind power technologies, discussed in chapter VII.

Table 52. Comparison of the public and occupational exposures assessed in this annex<sup>a,b</sup>

	<i>Nuclear fuel cycle</i>	<i>Coal</i>	<i>Modern coal plant</i>	<i>Older coal plant</i>	<i>Natural gas</i>	<i>Oil</i>	<i>Geothermal</i>	<i>Solar PV</i>	<i>Wind</i>	<i>Biomass</i>
COLLECTIVE DOSES NORMALIZED TO ELECTRICITY GENERATION (man Sv/(GW a))										
Public	U mining and milling	0.2	Coal mining (Rn discharge)	0.4	0.4					
	Nuclear power plant operation	0.2	Coal plant operation	0.1	0.8					
	Reprocessing	0.03	Ash, radon emanation	0.2	0.2					
Total public (not including globally circulating radionuclides)		0.43		0.7	1.4	0.1	0.000 3	1–20		
Total public (including globally circulating radionuclides)	100 years	3.0								
	500 years	5.5								
	10 000 years	25								
Occupational		2.7 <sup>c</sup>		11	11	0.01	0.15	0.05		
Occupational - decommissioning, nuclear		1.8								
Occupational - mining for construction		0.02		0.01	0.01	0.01		0.8	0.1	0.01
COLLECTIVE DOSES (man Sv)										
Public	U mining and milling	53	Coal mining (Rn discharge)	370	370					
	Nuclear power plant operation	68	Coal plant operation	60	780					
	Reprocessing	8	Ash, radon emanation	240	240					
Total public (not including globally circulating radionuclides)		130		670	1 400	55	0.03	5–160		

	<i>Nuclear fuel cycle</i>		<i>Coal</i>	<i>Modern coal plant</i>	<i>Older coal plant</i>	<i>Natural gas</i>	<i>Oil</i>	<i>Geothermal</i>	<i>Solar PV</i>	<i>Wind</i>	<i>Biomass</i>
Total public (including globally circulating radionuclides)	100 years	910									
	500 years	1 700									
	10 000 years	7 600									
Occupational		788		11 000	11 000	7	17	0.4–0.8			
Decommissioning (occupational) per nuclear reactor		5									
Occupational - mining for construction		6		7	7	3			3	4	0.4

<sup>a</sup> Projections of any health effects using collective doses in the table are not recommended.

<sup>b</sup> All estimates are calculated based on best estimates; site- and location-specific collective doses are not presented.

<sup>c</sup> From UNSCEAR 2008 Report.

## C. Commentary on significance of accidents

219. While this annex has focused on comparing the exposures from normal operations of the various electricity-generating technologies, a commentary is needed regarding the risk of serious accidents that give rise to radiation exposure. This is clearly only significant for nuclear power. While it is beyond the competence of the Committee to assess the probability of any future accident, the Committee has assessed information on past accidents that have exposed the public and workers, notably the 1986 accident at the Chernobyl nuclear power plant in the former Soviet Union (UNSCEAR 2008 Report, annexes C and D [U12]). Moreover since that report, the Committee has conducted an assessment of the levels and effects of radiation exposure due to the 2011 nuclear accident at the Fukushima Daiichi nuclear power station (FDNPS). The UNSCEAR 2013 Report [U13] gave estimates of the collective doses to the population of Japan due to the FDNPS accident. These estimates were compared with the previous estimates by the Committee for populations of European countries exposed to radiation following the 1986 Chernobyl accident in the former Soviet Union. This comparison is shown in table 53.

Table 53. Estimates of the collective effective doses from the FDNPS and Chernobyl accidents [U13]

<i>Accident</i>	<i>Collective effective dose (thousand man Sv)</i>		
	<i>Over first year</i>	<i>Over ten years</i>	<i>Up to age 80 years<sup>a</sup></i>
Fukushima Daiichi nuclear power station	18	36	48
Chernobyl Unit 4			400

<sup>a</sup> Summing the dose to all exposed individuals integrated from their age at the time of the accident until they reach age 80 years.

220. Comparing radiation doses alone, it is clear that serious accidents give rise to collective doses that are very many times greater than collective doses due to normal operations. For example, the collective dose from the single accident at Chernobyl Unit 4 is more than 400 times the annual global collective dose to the public from all nuclear power. Such a comparison of collective doses can be made only in order to gain perspective on the magnitude of the radiological impact. However, great care must be taken when assimilating these comparisons, because there are obviously many major non-radiological differences between accidents and normal operations for electricity generation. While collective doses from such accidents have been much larger than those from annual normal operations, the distribution of doses is more localized geographically, whereas the collective doses from normal operations for electricity generation are population-averaged over geographical regions or the world as a whole.



## IX. RESEARCH NEEDS

221. The use of electricity is ubiquitous throughout the world and the demand for electricity continues to grow. Because of the prevalence of different types of electricity-generating technologies coupled with the diversity inherent in the countries of the world, standard data on exposures to radioactive discharges or materials is non-uniform or non-existent. Thus, any study comparing different electricity-generating technologies will suffer from inconsistent or incomplete databases. This annex has used consistent methodologies together with sound judgement on the use and interpretation of available data to assess public and occupational exposures from electricity-generating technologies. Some specific areas of interest that would improve understanding or that would increase the certainty of this work are included in this section.

222. *Data.* Consistent data on radioactive discharges across all electricity-generating technologies, including how they change with time and changing practices across all electricity-generating technologies, would improve the ability to assess and compare these technologies. Data on occupational exposures and their change with time and practice for each technology would also help. The following lists some specific needs that have been identified:

(a) Decommissioning of coal power plants generates NORM wastes, the magnitude of which should be quantified (NORM wastes are naturally occurring radionuclides such as lead and polonium which in this case become plated out in pipes and the boiler, and other mechanical parts of the plant [M5]). Occupational exposures received during decommissioning of coal power plants need to be monitored in a representative manner in order to allow assessment of this exposure route for workers. This is also true regarding occupational exposures of workers decommissioning nuclear power plants.

(b) The combustion of natural gas and oil for electricity generation causes naturally occurring radionuclides to accumulate in the pipes. Assessment of any occupational or public exposures from this source is dependent on representative data on the activity concentrations that occur. There are some data available on this, however the measured external gamma exposure rates are of more significance.

(c) In order to assess the occupational doses resulting from the management of radioactive waste generated in nuclear power plants, representative data on doses received by workers needs to be collected or compiled [M5].

(d) Information on the proportion of nuclear fuel reprocessed for peaceful (i.e. electricity generation) versus non-peaceful (i.e. military applications) has only been available for the La Hague, France reprocessing facility and therefore the assessment of the doses due to discharges from reprocessing activities was compromised by the lack of open information. Also, some of the occupational doses at reprocessing facilities, such as Sellafield in the United Kingdom, are from the reprocessing of historical wastes so it is very hard to relate occupational doses to just nuclear fuel that has been reprocessed, or to electricity generation. Actual data on reprocessing activities related to electricity generation are needed to improve the exposure assessments.

(e) Storage, transmission and distribution of electricity are not included in the assessments of dose from electricity generation presented in this annex. These infrastructures are used regardless of the type of electricity generation (although there are differences between centralized and distributed grid systems that are optimal for different technologies), and these kinds of dose assessments could be included in any future update of the evaluations presented in the annex.

223. Databases could be consistent and standardized; these types of efforts are currently conducted by various international organizations. The success of these efforts, however, depends on the volunteer compliance of member countries submitting annual reports to these organizations, such as UNSCEAR, IAEA and NEA, and on funding and interest to keep the programmes current. These programmes would benefit from extending the data-collection schemes to include all relevant technologies, and investing in research to identify significant parameters to help design streamlined data-collection schemes that would further decrease the burden on member countries and data-collecting organizations.

224. *Uranium mining using the ISL process.* Explanations were given in chapter IV of the assumptions made about radon releases during uranium mining using the ISL process. Existing data are inconclusive, and radon could be released in varying quantities from the lixiviant used to dissolve the uranium in the underground ore body, depending on the specifics of the process. Determining more precisely the amount of radon releases from ISL uranium recovery, and how to better generalize them, requires additional research and a more complete understanding of the variation in the global processes and procedures currently in use for mining of uranium using the ISL process.

225. *Recycling of metals.* In chapter VII on assessing doses from the mining of metals needed in the construction phase, several assumptions were made in the assessments. Although the assumptions affect the absolute value of the assessed collective doses, the relative importance when comparing the different electricity-generating technologies with regards to the construction phase should remain relevant. However, these assumptions make a difference when comparing to the other components in the full cycle of electricity generation, such as in table 52. One area of importance that could be studied further is the effect of recycling metals, which has not been included in the present study because of insufficient data for large portions of the world. By not explicitly considering recycling, the collective dose per unit of electricity generated due to the extraction and processing of the metals used in the construction of a facility is likely to be overestimated by around a factor of two on average, and possibly a factor of five or more for some regions of the world with developed recycling processes (assuming the recycled metal is not contaminated with radioactive material). Also, recycling may affect the different technologies somewhat differently because it is more difficult and costly to recycle electronics and components (such as in solar panels) than larger bulk metal objects (such as in more conventional power plant components).

226. *Reference year.* This annex concentrates on the reference year 2010 for the assessments. Lifetime commitments would be relevant for comparing the full impact of the different electricity-generating technologies. Confounders in this type of extrapolation are associated with the changes in the respective electricity-generating technologies over time, caused by, for example, improving effectiveness of each technology in both economic and environmental terms and in radiation protection practices.

227. *Suess effect.* The displacement of  $^{14}\text{C}$  in atmospheric  $\text{CO}_2$  discharges during the coal cycle and other fossil fuel releases of  $\text{CO}_2$  (which are depleted in  $^{14}\text{C}$ ) is known as the Suess effect. Research into this effect would improve knowledge of the global carbon cycle and could help clarify the role of  $^{14}\text{C}$  in human exposures in the modern world.

## X. CONCLUSIONS

228. This annex provides estimates of exposures from the various electricity-generating technologies that (a) may be used by researchers and policy-makers in their own more comprehensive assessments for developing energy policy; (b) can be used to help inform the media and the public on these matters in a balanced perspective; and (c) can highlight possible emerging issues or opportunities for improvement that may warrant more attention and scrutiny, or future research. The following summarizes the findings.

229. The Committee has updated its methodology for estimating public exposures due to radioactive discharges, which is now more flexible for use in evaluating radiation exposures to the public from diverse electricity-generating technologies. This methodology along with extensive data collection and analyses has provided the Committee with a sounder basis for comparative studies than was possible earlier. The Committee has also re-evaluated occupational exposures arising from different electricity-generating technologies relying on data mainly from dosimetry records of worker exposures. These evaluations comprised the basis for the current comparative study on radiation exposures of both the public and of workers from electricity generation. To compare exposures, the Committee has focused on two metrics. These were (a) the collective doses to defined population groups integrated over specific time periods resulting from one year's electricity generation by each technology in each geographical region and for the world as a whole, and (b) the relevant collective doses divided by the amount of electricity generated by each technology. The year 2010 was used as the reference year for the comparisons.

230. The Committee has conducted this comparative study by investigating sources of radiation exposure from electricity-generating technologies based on the (a) nuclear fuel cycle, (b) coal cycle, the combustion of natural gas, oil and biofuels, and (c) geothermal, wind and solar power. Two electricity-generating technologies (nuclear fuel cycle and coal cycle) were investigated in detail because a more robust database existed for these technologies. The Committee evaluated the main sources of radioactive discharges from the life cycle of these electricity-generating technologies. For the nuclear fuel cycle, these were uranium mining, milling and mill tailings, power plant operation, spent fuel reprocessing, and decommissioning activities. For the coal cycle, they were the mining for coal, power plant operation for both a modern coal plant and an older-style coal plant, and coal ash deposits.

231. The Committee estimated that, excluding long-lived globally circulating radionuclides, the contribution from the coal cycle, assuming discharges from a modern coal plant, was more than half of the total collective dose to the global public from the discharges due to a single year's global electricity generation, while the nuclear fuel cycle contributed less than a fifth. The contribution from the coal cycle comes from discharges of natural radionuclides (primarily radon and its radioactive progeny) during coal mining, combustion of coal at the power plant and from coal ash deposits. Similarly, almost half of the contribution to public exposures from the nuclear fuel cycle also comes from discharges of natural radionuclides during uranium mining and milling activities. These values depend on the amount of electricity generated by each technology; in 2010, the coal cycle produced the largest amount of total electricity generated, about 40%. Although radon and its progeny are relatively important contributors to collective doses to the public for both the nuclear fuel cycle and the coal cycle, the associated individual doses are small compared with doses due to inhalation of naturally occurring radon [U9, W7].

232. The Committee found, however, that the contribution to the collective dose to the public from each electricity-generating technology was not only because of how much electricity each technology generated. There were differences due to the collective doses per unit of electricity generated. In normal operations, the coal cycle gives a higher collective dose per unit of electricity generated than electricity generation from nuclear power plants, and significantly higher than the other technologies evaluated—with the exception of geothermal energy. Based on the limited information on radon discharges from geothermal power plants, the collective dose per unit of electricity generated by geothermal energy could be significant. However, because the use of geothermal technology is not widespread, its contribution to radiation exposures of the global public is smaller than that of the coal cycle.

233. Previous investigations on electricity generation from the nuclear fuel cycle have examined the contribution to human exposures made by long-lived radionuclides, such as carbon-14, which are discharged, circulate globally and continue to contribute to radiation exposures of the public centuries into the future, albeit as extremely small individual doses. The Committee found that public exposures from these globally-circulating radionuclides, for one year of discharge and integrated to 100 years, result in a contribution to exposures from the nuclear fuel cycle that are about the same as the coal cycle. Over long integration times such as hundreds of years, the contribution from these radionuclides results in larger collective doses to the global public from the nuclear fuel cycle than the coal cycle.

234. The Committee also assessed the occupational exposures for these technologies. The largest collective dose to workers per unit of electricity generated resulted from coal mining, because of exposures to naturally occurring radionuclides. Of all the collective doses evaluated, to both the public and workers, the exposure of workers from coal mining gave the largest contribution, although it has fallen over time because of better mining conditions. Regarding the mining of rare earth metals needed for construction, by far the largest collective dose to workers per unit of electricity generated assessed in this study came from solar power, followed by wind power. This is because the workers are exposed to natural radionuclides during mining, and the amount of low-grade ore required to be mined for these technologies is high.

235. The total collective dose (i.e. to the global public and all exposed workers combined) per unit of electricity generated by the coal cycle was larger than that generated by the nuclear fuel cycle, even when considering the long-lived globally-circulating radionuclides integrated out to 500 years. When considering the amount of electricity generated in the year 2010 by each technology, the coal cycle resulted in the largest collective dose to the global public and workers combined, followed by the nuclear fuel cycle. Of the remaining technologies, geothermal energy and combustion of natural gas were the next largest contributors.

236. Great care should be taken when interpreting and using these results, because this analysis only gives a perspective on the magnitude and differences of radiation exposures, and cannot be used to determine whether one form of energy generation is preferable to another. As stated earlier, a number of factors determine why a certain mix of energy generation technologies may be selected by countries. Radiation exposure is only one of them.

237. Moreover, when comparing collective doses for the various electricity-generating technologies, it is important to note that the collective dose from serious accidents, such as those that occurred at the Chernobyl and Fukushima-Daiichi nuclear power stations, were orders of magnitude larger than the collective doses to the world population from one year's normal operation of all the technologies of electricity generation that were assessed in the annex. More significantly, the distribution of doses after an accident is more localized geographically (local populations receive higher doses than the average), whereas the collective doses from normal operations for electricity generation are often averaged over populations within each geographical region or the world as a whole.

## XI. ACKNOWLEDGEMENTS

The Committee wishes to acknowledge with gratitude the experts directly involved in compiling data, conducting analyses and quality control checks, and drafting text and conclusions, and the support staff in their institutes who assisted them. In particular, the Committee would like to thank: the consultant, L. Hubbard; the expert group, who provided valuable oversight and advice for the work; staff, T. Anderson and K. Jones, from Public Health England in the United Kingdom, who conducted many of the analyses; L. Anspaugh, H. Grogan, V. Holahan and J. Simmonds, who provided helpful advice, drafted text, and reviewed and checked the results. The views expressed in this scientific annex and related material remain those of the Committee and do not necessarily represent the views of individual experts, the United Nations or its Member States.

### *Expert group*

*Co-chairs:* E. Waller (Canada)

*Members:* T. Anderson (United Kingdom), L. Anspaugh (United States), H. Grogan (United States), G. Hirth (Australia), V. Holahan (United States), K. Jones (United Kingdom), L. Hubbard (Sweden), R. Michel (Germany), J. Simmonds (United Kingdom)

*Observer:* G. Proehl (IAEA)

The Committee would also like to acknowledge with gratitude: E. Rochedo, who conducted some of the preparatory work to compile data; B. Lauritzen, who compiled some of the data and conducted some of the analyses on occupational exposures due to mining of metals for construction purposes; and M. Tzivaki for conducting some specialized quality checks of the calculations.



## REFERENCES

- A1 ACAA. The American Coal Ash Association. [Internet] Available from ([www.ACAA-USA.org](http://www.ACAA-USA.org)) on 13.01.2016.
- A2 ACAA. 2010 Coal Combustion Product (CCP) production and use survey report. American Coal Ash Association. [Internet] Available from ([https://www.acao-usa.org/Portals/9/Files/PDFs/2010\\_CCP\\_Survey\\_FINAL\\_102011.pdf](https://www.acao-usa.org/Portals/9/Files/PDFs/2010_CCP_Survey_FINAL_102011.pdf)) on 28.02.2016.
- A3 AK Steel. Product data sheet. 316/316L stainless steel. UNS S31600 and UNS S31603. AK Steel Corporation. [Internet] Available from ([http://www.aksteel.com/pdf/markets\\_products/stainless/austenitic/316\\_316L\\_data\\_sheet.pdf](http://www.aksteel.com/pdf/markets_products/stainless/austenitic/316_316L_data_sheet.pdf)) on 24.03.2016.
- A4 Al-Masri, M.S. and R. Shwiekani. Radon gas distribution in natural gas processing facilities and workplace air environment. *J Environ Radioact* 99(4): 574-580 (2008).
- A5 Al-Masri, M.S. and K. Haddad. NORM emissions from heavy oil and natural gas fired power plants in Syria. *J Environ Radioact* 104: 71-74 (2012).
- A6 Al-Masri, M.S., K. Haddad, A.W. Doubal et al. Assessment of soil contamination by (210)Po and (210)Pb around heavy oil and natural gas fired power plants. *J Environ Radioact* 132: 89-93 (2014).
- A7 Al-Saleh, F.S. and G.A. Al-Harshan. Measurements of radiation level in petroleum products and wastes in Riyadh City Refinery. *J Environ Radioact* 99(7): 1026-1031 (2008).
- A8 Althaus, H.-J., R. Hischer, M. Osses et al. Life cycle inventories of chemicals. Data v2.0. Ecoinvent Report No. 8. Swiss Centre for Life Cycle Inventories, Dübendorf, CH, 2007.
- A9 ANL. Energy and land use. DOE/EV/10154-5. Argonne National Laboratory, 1981.
- A10 Anspaugh, L.R. Final report on the investigation of the impact of the release of radon-222, its daughters, and precursors at The Geysers Geothermal Field and surrounding area. MISC-2818. Lawrence Livermore National Laboratory, Livermore, California, 1978.
- B1 Behlen Building Systems. Facts on building green. Behlen Building Systems. [Internet] Available from (<http://www.behlenbuildingsystems.com/BuildingGreen.htm#RecycledContent>) on 24.11.2015.
- B2 Bell, K.G., C. Goodman and W.L. Whitehead. Radioactivity of sedimentary rocks and associated petroleum. *Bull Am Assoc Petrol Geol* 24(9): 1529-1547 (1940).
- B3 Borromeo, J. Darlington Radiological Environmental Monitoring Report (REMP) Review. NK38-REP-03481-10003-R000. Ontario Power Generation, 2008.
- B4 Britannica. The nuclear fuel cycle. Britannica Nuclear Reactors. [Internet] Available from (<http://www.britannica.com/EBchecked/topic/421763/nuclear-reactor/307282/Emergency-response?anchor=ref272869>) on 02.05.2015.
- B5 Brown, A. Pickering Radiological Environmental Monitoring Report (REMP) Review - 2006. P-REP-03481-00002-R000. Ontario Power Generation, 2007.

- B6 Brown, S.H. and R.C. Smith. A model for determining the overall radon release rate and annual source term for a commercial in-situ leach uranium facility (Chapter 119). in: International Conference on Radiation Hazards in Mining: Control, Measurement and Medical Aspects, 4-9 October 1981, Colorado School of Mines, Golden, CO (M. Gomez, ed.) Society of Mining Engineers of the American Institute of Mining, Metallurgical, and Petroleum Engineers, New York, 1981.
- B7 Brown, S.H. Design improvements and ALARA at U.S. uranium in situ recovery facilities. pp.649-664 in: ASME 2009 Proceedings of the 12th International Conference on Environmental Remediation and Radioactive Waste Management, Liverpool, UK, 11-15 October 2009. Paper no. ICEM2009-16415. The American Society of Mechanical Engineers (ASME), 2009.
- B8 Bryan, R.H. and I.T. Dudley. Estimated quantities of materials contained in a 1000-MW(e) PWR power plant. ORNL-TM-4515. OAK Ridge National Laboratory, Tennessee, 1974.
- B9 Bunce, L.A. and F.W. Sattler. Radon-222 in natural gas. Radiol Health Data Rep 7(8): 441-444 (1966).
- C1 Capudean, B. Carbon content, steel classifications and alloy steels. Fabricators & Manufacturers Association, Intl. [Internet] Available from (<http://www.thefabricator.com/article/metalsmaterials/carbon-content-steel-classifications-and-alloy-steels>) on 24.02.2012.
- C2 Cheng, C. 2011 Results of Radiological Environmental Monitoring Programs. N-REP-03481-10010-R000. Ontario Power Generation, 2012.
- C3 Classen, M., H.-J. Althaus and S. Blaser. Life cycle inventories of metals. Data v2.1. Ecoinvent Report No. 10. Swiss Centre for Life Cycle Inventories, Dübendorf, CH, 2009.
- C4 Coles, D.G., R.C. Ragaini and J.M. Ondov. Behavior of natural radionuclides in western coal-fired power plants. Environ Sci Technol 12(4): 442-446 (1978).
- C5 Corbett, J.O. The radiation dose from coal burning: a review of pathways and data. Radiat Prot Dosim 4(1): 5-19 (1983).
- D1 D'Amore, F. Radon-222 survey in Larderello geothermal field, Italy (Part 1). Geothermics 4(1): 96-108 (1975).
- D2 Dannemand Andersen, P., M. Borup and T. Krogh. Managing long-term environmental aspects of wind turbines: a prospective case study. Int J Technol Policy Manage 7(4): 339-354 (2007).
- D3 de Jong, P., W. van Dijk, E.R. van der Graaf et al. National survey on the natural radioactivity and <sup>222</sup>Rn exhalation rate of building materials in The Netherlands. Health Phys 91(3): 200-210 (2006).
- D4 de Jong, P., W. van Dijk and M. de Rooij. Influence of the porosity on the (<sup>222</sup>)Rn exhalation rate of concrete. Health Phys 100(2): 127-137 (2011).
- D5 Dones, R., C. Bauer, R. Bolliger et al. Life cycle inventories of energy systems: Results for current systems in Switzerland and other UCTE countries. Data v2.0. Ecoinvent Report No. 5. Swiss Centre for Life Cycle Inventories, Dübendorf, CH, 2007.
- D6 Drummond, I., P. Boucher, B. Bradford et al. Occurrence of <sup>222</sup>Rn and progeny in natural gas processing plants in western Canada. Health Phys 59(1): 133-137 (1990).



- E1 EC. Assessment of the radiological impact on the population of the European Union from European Union nuclear sites between 1987 and 1996. Radiation Protection 128 (J.G. Smith et al., eds.). European Communities, Luxembourg, 2002.
- E2 EC. European Commission Radioactive Discharges Database (RADD) for collecting, storing, exchanging and dissemination of information on radioactive discharges. European Commission. [Internet] Available from (<http://europa.eu/radd/>) on 9 and 21 December 2015.
- E3 EPRI. Coal ash: Characteristics, management and environmental issues. Technical Update. Electric Power Research Institute. [Internet] Available from (<http://www.epri.com/abstracts/Pages/ProductAbstract.aspx?ProductId=00000000001019022>).
- F1 Feuerborn, H.-J. Coal Combustion Products in Europe - an update on production and utilisation, standardisation and regulation. World of Coal Ash (WOCA) Conference, Denver, CO, USA, 9-12 May 2011.
- F2 FSUE. ОТЧЕТ по экологической безопасности ФГУП «Производственное объединение «Маяк» за 2013 год, Report on the Environmental Safety of the Federal State Unitary Enterprise "Production Association Mayak" in 2013. Eco-report-2013-Mayak. Federal State Unitary Enterprise, Ozersk, 2014. (Russian).
- F3 Fthenakis, V. and H.C. Kim. Land use and electricity generation: A life-cycle analysis. Renewable and Sustainable Energy Reviews 13(6-7): 1465-1474 (2009).
- G1 George, A.C., G. Scandiffio and A.J. Breslin. The distribution of radon and radon daughters in the geothermal region of Larderello. pp.3-14 in: Proceedings - Second DOE-ENEL Workshop for Cooperative Research in Geothermal Energy. LBL-11555. Lawrence Berkeley Laboratory, California, 1980.
- G2 Gesell, T.F. Occupational radiation exposure due to 222Rn in natural gas and natural gas products. Health Phys 29(5): 681-687 (1975).
- G3 Globalspec. Carbon steels and alloy steels information. [Internet] Available from ([http://www.globalspec.com/learnmore/materials\\_chemicals\\_adhesives/metals\\_alloys/ferrous\\_metals\\_alloys/carbon\\_steels\\_alloy\\_steels](http://www.globalspec.com/learnmore/materials_chemicals_adhesives/metals_alloys/ferrous_metals_alloys/carbon_steels_alloy_steels)) on 27.02.2012.
- G4 Green, D.E. and V. Downing. The report on the pilot study for the measurement of the occupational exposure of Drax Power Station staff to airborne dust. NER/SSD/M/80/45. UK Central Electricity Generating Board, 1981.
- G5 Green, D.E. and M.M. Tylee. The report on the pilot study for the measurement of the occupational exposure of Ferrybridge "B" Power Station staff to airborne dust. NER/SSD/M/81/180. UK Central Electricity Generating Board, 1981.
- H1 Hamlat, M.S., S. Djefal and H. Kadi. Assessment of radiation exposures from naturally occurring radioactive materials in the oil and gas industry. Appl Radiat Isot 55(1): 141-146 (2001).
- H2 Hedvall, R. and B. Erlandsson. Radioactivity concentrations in non-nuclear industries. J Environ Radioact 32(1-2): 19-31 (1996).
- H3 Heidrich, C., S. Brown and D. Collier. Naturally occurring radionuclides in Australian Coal Combustion Products (CCPs). World of Coal Ash (WOCA) Conference, Denver, CO, USA, 9-12 May 2011.

- I1 IAEA. Radiation protection and the management of radioactive waste in the oil and gas industry. Safety Reports Series No. 34. International Atomic Energy Agency, Vienna, 2003.
- I2 IAEA. Extent of environmental contamination by naturally occurring radioactive material (NORM) and technological options for mitigation. Technical Reports Series No. 419. International Atomic Energy Agency, Vienna, 2003.
- I3 IAEA. Extending the operational life span of nuclear plants. Major International Conference on Nuclear Plant Life Managements, Shanghai, 15-18 October 2007. International Atomic Energy Agency. [Internet] Available from (<https://www.iaea.org/newscenter/news/extending-operational-life-span-nuclear-plants>).
- I4 IAEA. World distribution of uranium deposits (UDEPO) with uranium deposit classification. IAEA-TECDOC-1629. International Atomic Energy Agency, Vienna, 2009.
- I5 IAEA. Measurement and calculation of radon releases from NORM residues. Technical Reports Series no. 474. International Atomic Energy Agency, Vienna, 2013.
- I6 IAEA. PRIS - Power Reactor Information System. International Atomic Energy Agency. [Internet] Available from (<http://www.iaea.org/pris/home.aspx>) on 11.10.2013.
- I7 IAEA. PRIS - Power Reactor Information System. International Atomic Energy Agency. [Internet] Available from (<http://www.iaea.org/pris/home.aspx>) on 18.11.2015.
- I8 IAEA. Permanent shutdown reactors. PRIS - Power Reactor Information System. International Atomic Energy Agency. [Internet] Available from (<http://www.iaea.org/PRIS/WorldStatistics/ShutdownReactorsByCountry.aspx>) on 20.07.2015.
- I9 IAEA. PRIS - Power Reactor Information System. International Atomic Energy Agency. [Internet] Available from (<https://www.iaea.org/pris/>) on 14.07.2015.
- I10 IAEA. Naturally occurring radioactive material (NORM VII). Proceedings of an International Symposium, Beijing, China, 22–26 April 2013. International Atomic Energy Agency, Vienna, 2015.
- I11 ICRP. Lung cancer risk from radon and progeny and statement on radon. ICRP Publication 115. Annals of the ICRP 40(1). International Commission on Radiological Protection, Elsevier Ltd., 2010.
- I12 IEA. World energy outlook 2004. International Energy Agency, OECD/IEA, 2004.
- I13 IEA. Key world energy statistics. International Energy Agency, OECD/IEA, Paris, 2008.
- I14 IEA. Coal information 2012. IEA Statistics. International Energy Agency, OECD/IEA, Paris, 2012.
- I15 IEA. Electricity information 2012. IEA Statistics. International Energy Agency, OECD/IEA, Paris, 2012.
- I16 IEA. World energy outlook 2012. International Energy Agency, OECD/IEA, Paris, 2012.
- I17 IEA. Energy statistics of OECD countries 2013. International Energy Agency, OECD/IEA, Paris, 2013.
- I18 IEA Clean Coal Centre. Life extension of coal-fired power plants. PF 05-13 (<http://www.iea-coal.org.uk/documents/81405/5990/Life-extension-of-coal-fired-power-plants>). International Energy Agency Clean Coal Centre, London, 2005.

- I19 InfoMine. Major mining operations around the world. [Internet] Available from (<http://www.infomine.com/minesite/>).
- I20 ISOE. ISOE database. Information System on Occupational Exposure. [Internet] Available from (<http://www.isoe-network.net/>) on 14.03.2016.
- J1 Jungbluth, N., M. Stucki and R. Frischknecht. Photovoltaics. Part XII. Data v2.1. ecoinvent report No. 6. Swiss Centre for Life Cycle Inventories, Dübendorf, CH, 2009.
- K1 Kable Intelligence Limited. The top 10 biggest geothermal power plants in the world. [Internet] Available from (<http://www.power-technology.com/features/feature-top-10-biggest-geothermal-power-plants-in-the-world/>) on 12.11.2013.
- K2 Kolb, W.A. and M. Wojcik. Enhanced radioactivity due to natural oil and gas production and related radiological problems. *Sci Total Environ* 45: 77-84 (1985).
- K3 Kruger, P., A. Stoker and A. Umaña. Radon in geothermal reservoir engineering. *Geothermics* 5(1-4): 13-19 (1977).
- K4 Kvasnicka, J. Radiation protection in the offshore petroleum industry. Volume 4. pp.4-625-627 in: IRPA9: Proceedings of the International Congress on Radiation Protection Association, Vienna, 14-19 April 1996.
- L1 Liu, F.D., Z.Q. Pan, S.L. Liu et al. The estimation of the number of underground coal miners and the annual dose to coal miners in China. *Health Phys* 93(2): 127-132 (2007).
- L2 Long, S., S. Sdraulig, B. Tate et al. A survey of naturally occurring radioactive material associated with mining. Technical Report Series No. 161. Australian Radiation Protection and Nuclear Safety Agency, 2012.
- L3 Lund, J.W. 100 years of geothermal power product. Proceedings, Thirtieth Workshop on Geothermal Reservoir Engineering, 31 January-2 February 2005, Stanford University, California. 2005.
- M1 Made How. How products are made: copper. Volume 4. [Internet] Available from (<http://www.madehow.com/Volume-4/Copper.html>) on 31.03.2011.
- M2 Marović, G., Z. Franić, J. Senčar et al. Natural radionuclides in coal and waste material originating from coal fired power plant. IRPA 12: International Congress of the International Radiation Protection Association - Strengthening Radiation Protection Worldwide, Buenos Aires, Argentina, 19-24 October 2008.
- M3 Matek, B. 2015 Annual U.S. & global geothermal power production report. Geothermal Energy Association, Washington, D.C., 2015.
- M4 McBride, J.R. Offsite radiological surveillance for Project Gasbuggy June 1967-July 1968. *Radiol Health Data Rep* 10(12): 535-546 (1969).
- M5 Mora, J.C., B. Robles, J.A. Corbacho et al. Modelling the behaviour of <sup>210</sup>Po in high temperature processes. *J Environ Radioact* 102(5): 520-526 (2011).
- N1 NEI. Nuclear Engineering International Handbook 2007. Nuclear Engineering International, Kent, UK, 2007.
- N2 NREL. Parabolic trough solar field technology. National Renewable Energy Laboratory. [Internet] Available from ([http://www.nrel.gov/csp/troughnet/solar\\_field.html](http://www.nrel.gov/csp/troughnet/solar_field.html)).

- N3 NREL. Life cycle greenhouse gas emissions from solar photovoltaics. NREL/FS-6A20-56487 (<http://www.nrel.gov/docs/fy13osti/56487.pdf>). National Renewable Energy Laboratory, 2012.
- N4 NREL. Wind LCA harmonization. NREL/FS-6A20-57131 (<http://www.nrel.gov/docs/fy13osti/57131.pdf>). National Renewable Energy Laboratory, 2013.
- O1 O'Donoghue, P.R., G.A. Heath, S.L. Dolan et al. Life cycle greenhouse gas emissions of electricity generated from conventionally produced natural gas. *J Ind Ecol* 18(1): 125-144 (2014).
- O2 OECD. Nuclear energy data 2007. NEA No. 6248. OECD Nuclear Energy Agency, 2007.
- O3 OECD. OECD Factbook 2011-2012. Economic, environmental and social statistics. Organisation for Economic Co-operation and Development, OECD Publishing, Paris, 2011.
- O4 OECD/NEA. Occupational exposures at nuclear power plants. Twentieth annual report of the ISOE programme, 2010. Information System on Occupational Exposure (ISOE). NEA/CRPPH/ISOE(2010)5. Jointly sponsored by the OECD Nuclear Energy Agency and the International Atomic Energy Agency. OECD, 2010.
- O5 OECD/NEA. Occupational exposures at nuclear power plants. Twenty-second annual report of the ISOE Programme, 2012. Information System on Occupational Exposure (ISOE). NEA/CRPPH/ISOE(2012)8. Jointly sponsored by the OECD Nuclear Energy Agency and the International Atomic Energy Agency. OECD, 2012.
- O6 OECD/NEA. Uranium 2011: Resources, Production and Demand. NEA No. 7059. A Joint Report by the OECD Nuclear Energy Agency and the International Atomic Energy Agency. OECD, 2012.
- O7 OECD/NEA. ISOE country reports. Information System on Occupational Exposure (ISOE). Jointly sponsored by the OECD Nuclear Energy Agency and the International Atomic Energy Agency. OECD, 2013.
- O8 OECD/NEA. Uranium 2014: Resources, Production and Demand. NEA No. 7209. A Joint Report by the OECD Nuclear Energy Agency and the International Atomic Energy Agency. OECD, 2014.
- O9 Organo, C. and D. Fenton. Radiological assessment of NORM industries in Ireland – Radiation doses to workers and members of the public. Radiological Protection Institute of Ireland, 2008.
- O10 Ortegon, K., L.F. Nies and J.W. Sutherland. Preparing for end of service life of wind turbines. *J Cleaner Prod* 39: 191-199 (2013).
- P1 Pasqualetti, M.J. Geothermal energy and the environment: The global experience. *Energy* 5(2): 111-165 (1980).
- P2 PDEP. Technologically Enhanced Naturally Occurring Radioactive Materials (TENORM) study report. Pennsylvania Department of Environmental Protection, Harrisburg, PA, 2015.
- R1 Razzano, F. and M. Cei. Geothermal power generation in Italy 2010-2014 Update Report. Proceedings World Geothermal Congress, Melbourne, Australia, 19-25 April 2015. International Geothermal Association, Bochum, Germany, 2015.
- R2 Richard, T.L. Challenges in scaling up biofuels infrastructure. *Science* 329(5993): 793-796 (2010).

- R3 Rood, A.S., G.J. White and D.T. Kendrick. Measurement of  $^{222}\text{Rn}$  flux,  $^{222}\text{Rn}$  emanation, and  $^{226}\text{Ra}$ ,  $^{228}\text{Ra}$  concentration from injection well pipe scale. *Health Phys* 75(2): 187-192 (1998).
- R4 Rowan, E.L. and T.F. Kraemer. Radon-222 content of natural gas samples from upper and middle Devonian sandstone and shale reservoirs in Pennsylvania: Preliminary data. Open-File Report Series 2012-1159. U.S. Geological Survey, Reston, Virginia, 2012.
- R5 Rule, B.M., Z.J. Worth and C.A. Boyle. Comparison of life cycle carbon dioxide emissions and embodied energy in four renewable electricity generation technologies in New Zealand. *Environ Sci Technol* 43(16): 6406-6413 (2009).
- S1 Sakoda, A., Y. Ishimori and K. Yamaoka. A comprehensive review of radon emanation measurements for mineral, rock, soil, mill tailing and fly ash. *Appl Radiat Isot* 69(10): 1422-1435 (2011).
- S2 Sánchez Delgado, M. and T. López Fernández. Uranium mill tailings piles remediation: remedial cleanup actions versus long term stewardship. pp.213-223 in: *Environmental Contamination from Uranium Production Facilities and their Remediation. Proceedings of an International Workshop, Lisbon, 11–13 February 2004*. International Atomic Energy Agency, Vienna, 2005.
- S3 Shelmet Precision Casting. Common stainless steel alloys. [Internet] Available from (<http://www.shelmetcastings.com/common-stainless-steel-alloys.html>) on 22.02.2012.
- S4 Smith, K.R., G.M. Crockett, W.B. Oatway et al. Radiological impact on the UK population of industries which use or produce materials containing enhanced levels of naturally occurring radionuclides: Part I: Coal-fired electricity generation. NRPB-R327. National Radiological Protection Board, Chilton, 2001.
- S5 Snavely Jr., E.S. Radioisotopes in produced water. A literature review. American Petroleum Institute, Dallas, Texas, 1989.
- S6 Solecki, A.T. and D.E. Tchorz-Trzeciakiewicz. Radon exhalation from the Upper Silesian coal ashes. *Geochem J* 45: 491-496 (2011).
- S7 Spath, P.L., M.K. Mann and D.R. Kerr. Life cycle assessment of coal-fired power production. NREL/TP-570-25119. National Renewable Energy Laboratory, Colorado, 1999.
- S8 Spath, P.L. and M.K. Mann. Life cycle assessment of a natural gas combined-cycle power generation system. NREL/TP-570-27715. National Renewable Energy Laboratory, Colorado, 2000.
- S9 Sullivan, J.L., C.E. Clark, J. Han et al. Life-cycle analysis results of geothermal systems in comparison to other power systems. ANL/ESD/10-5. Argonne National Laboratory, Illinois, 2010.
- T1 Tadmor, J. Atmospheric release of volatilized species of radioelements from coal-fired plants. *Health Phys* 50(2): 270-273 (1986).
- T2 Tang, Z., S. Ma, J. Ding et al. Current status and prospect of fly ash utilization in China. 2013 World of Coal Ash (WOCA) Conference, Lexington, KY, 22-25 April 2013. <http://www.flyash.info/>. 2013.

- T3 Tata Steel. The recycled content of steel. Tata Steel Europe Limited [Internet] Available from ([http://www.tatasteeleurope.com/en/company/activities/strip\\_products\\_uk/the\\_environment/positive\\_environmental\\_characteristics/recyclability/the\\_recycled\\_content\\_of\\_steel/](http://www.tatasteeleurope.com/en/company/activities/strip_products_uk/the_environment/positive_environmental_characteristics/recyclability/the_recycled_content_of_steel/)).
- T4 Tokonami, S. and T. Ishikawa. Radiological aspects of using coal ash (slag) in the building industry. *Jpn J Health Phys* 42(3): 227-233 (2007).
- U1 UKQAA. UK Quality Ash Association: the power behind PFA. UK Quality Ash Association. [Internet] Available from (<http://www.ukqaa.org.uk/wp-content/uploads/2014/03/6-sided-re-branded-Mar-2014.pdf>) on 01.03.2016.
- U2 UN. The energy challenge for achieving the millennium development goals. UN Energy Paper June 22, 2005. United Nations Energy, 2005.
- U3 UNDP. UNDP and energy access for the poor: energizing the millennium development goals. United Nations Development Programme, 2010.
- U4 UNSCEAR. Official Records of the General Assembly, Thirteenth Session, Supplement No. 17 (A/3838). UNSCEAR 1958 Report. United Nations Scientific Committee on the Effects of Atomic Radiation. United Nations, New York, 1958.
- U5 UNSCEAR. Sources and Effects of Ionizing Radiation. UNSCEAR 1977 Report. United Nations Scientific Committee on the Effects of Atomic Radiation, 1977 Report to the General Assembly, with annexes. United Nations sales publication E.77.IX.1. United Nations, New York, 1977.
- U6 UNSCEAR. Ionizing Radiation: Sources and Biological Effects. UNSCEAR 1982 Report. United Nations Scientific Committee on the Effects of Atomic Radiation, 1982 Report to the General Assembly, with annexes. United Nations sales publication E.82.IX.8. United Nations, New York, 1982.
- U7 UNSCEAR. Sources, Effects and Risks of Ionizing Radiation. UNSCEAR 1988 Report. United Nations Scientific Committee on the Effects of Atomic Radiation, 1988 Report to the General Assembly, with annexes. United Nations sales publication E.88.IX.7. United Nations, New York, 1988.
- U8 UNSCEAR. Sources and Effects of Ionizing Radiation. UNSCEAR 1993 Report. United Nations Scientific Committee on the Effects of Atomic Radiation, 1993 Report to the General Assembly, with scientific annexes. United Nations sales publication E.94.IX.2. United Nations, New York, 1993.
- U9 UNSCEAR. Sources and Effects of Ionizing Radiation. Volume I: Sources. UNSCEAR 2000 Report. United Nations Scientific Committee on the Effects of Atomic Radiation, 2000 Report to the General Assembly, with scientific annexes. United Nations sales publication E.00.IX.3. United Nations, New York, 2000.
- U10 UNSCEAR. Effects of Ionizing Radiation. Volume II: Scientific Annexes C, D and E. UNSCEAR 2006 Report. United Nations Scientific Committee on the Effects of Atomic Radiation. United Nations sales publication E.09.IX.5. United Nations, New York, 2009.
- U11 UNSCEAR. Sources and Effects of Ionizing Radiation. Volume I: Sources: Report to the General Assembly, Scientific Annexes A and B. UNSCEAR 2008 Report. United Nations Scientific Committee on the Effects of Atomic Radiation. United Nations sales publication E.10.XI.3. United Nations, New York, 2010.

- U12 UNSCEAR. Sources and Effects of Ionizing Radiation. Volume II: Effects. Scientific Annexes C, D and E. UNSCEAR 2008 Report. United Nations Scientific Committee on the Effects of Atomic Radiation. United Nations sales publication E.11.IX.3. United Nations, New York, 2011.
- U13 UNSCEAR. Sources, Effects and Risks of Ionizing Radiation. Volume I: Report to the General Assembly and Scientific Annex A. UNSCEAR 2013 Report. United Nations Scientific Committee on the Effects of Atomic Radiation. United Nations sales publication E.14.IX.1. United Nations, New York, 2014.
- U14 USDE. Energy efficiency & renewable energy. Office of Energy Efficiency & Renewable Energy. U.S. Department of Energy. [Internet] Available from ([http://www.eere.energy.gov/basics/renewable\\_energy/crystalline\\_silicon.html](http://www.eere.energy.gov/basics/renewable_energy/crystalline_silicon.html)) on 12.03.2015.
- U15 USDE. Steel industry profile (30 January 2012). Office of Energy Efficiency & Renewable Energy. U.S. Department of Energy. [Internet] Available from ([http://www1.eere.energy.gov/manufacturing/resources/steel\\_profile.html](http://www1.eere.energy.gov/manufacturing/resources/steel_profile.html)) on 23.02.2012.
- U16 USDOL. Industries at a glance. Oil and gas extraction: NAICS 211. US Department of Labor, Bureau of Labor Statistics. [Internet] Available from (<http://www.bls.gov/iag/tgs/iag211.html>) on 23.02.2012.
- U17 USEIA. Open data. International Energy Statistics. U.S. Energy Information Administration. [Internet] Available from (<https://www.eia.gov/opedata/>) on 12.04.2012.
- U18 USEIA. Nuclear explained. US Energy Information Administration. [Internet] Available from (<http://eia.doe.gov/cneaf/nuclear/page/intro.html>) on 02.05.2014.
- U19 USEIA. Table CT8. Electric power sector consumption estimates, 1960–2013, United States. U.S. Energy Information Administration. [Internet] Available from ([eia.gov/state/seds/data.cfm?incfile=/state/seds/sep\\_use/eu/use\\_eu\\_US.html&sid=US](http://eia.gov/state/seds/data.cfm?incfile=/state/seds/sep_use/eu/use_eu_US.html&sid=US)).
- U20 USEIA. Frequently asked questions: How much coal, natural gas, or petroleum is used to generate a kilowatthour (kWh) of electricity? U.S. Energy Information Administration. [Internet] Available from ([eia.gov/tools/faqs/faq.cfm?id=667&t=2](http://eia.gov/tools/faqs/faq.cfm?id=667&t=2))
- U21 USEPA. Coal ash basics. United States Environmental Protection Agency. [Internet] Available from ([www.epa.gov/coalash/coal-ash-basics](http://www.epa.gov/coalash/coal-ash-basics)) on 09.07.2014.
- U22 USEPA. Copper mining and production wastes (8 July 2011). U.S. Environmental Protection Agency. [Internet] Available from (<http://www.epa.gov/radiation/tenorm/copper.html>) on 28.02.2012.
- U23 USGS. Radioactive elements in coal and fly ash: Abundance, forms, and environmental significance. Fact Sheet FS-163-97. U.S. Geological Survey, 1997.
- U24 USNRC. Occupational radiation exposure at commercial nuclear power reactors and other facilities 2010. NUREG-0713, Vol. 32. U.S. Nuclear Regulatory Commission, 2012.
- U25 USNRC. Capacity factor (net). [Internet] Available from (<http://www.nrc.gov/reading-rm/basic-ref/glossary/capacity-factor-net.html>) on 03.03.2016.
- V1 van der Heijde, H.B., H. Beens and A.R. de Monchy. The occurrence of radioactive elements in natural gas. *Ecotoxicol Environ Saf* 1(1): 49-87 (1977).

- V2 van Netten, C., K. Kan, J. Anderson et al. Radon-222 and gamma ray levels associated with the collection, processing, transmission, and utilization of natural gas. *Am Ind Hyg Assoc J* 59(9): 622-628 (1998).
- W1 Waggitt, P.W. Uranium mine rehabilitation: the story of the South Alligator Valley intervention. *J Environ Radioact* 76(1-2): 51-66 (2004).
- W2 Wang, C., W. Liu, F. Chen et al. Estimation of radon emissions from coal mining in China. Paper provided by the Chinese delegation. Official communication to the UNSCEAR secretariat. 2015.
- W3 Wang, C., M. Wang and G. Liu. Radiation exposure to rare earth workers in China. Data provided by the Chinese delegation. Official communication to the UNSCEAR secretariat. 2015.
- W4 WCI. Coal and steel. World Coal Institute, UK, 2009.
- W5 White, S.W. and G.L. Kulcinski. Birth to death analysis of the energy payback ratio and CO<sub>2</sub> gas emission rates from coal, fission, wind and DT fusion electrical power plants. UWFDM-1063. University of Wisconsin, Madison, 1998.
- W6 Whitehead, N.E., B.J. Barry, R.G. Ditchburn et al. Systematics of radon at the Wairakei geothermal region, New Zealand. *J Environ Radioact* 92(1): 16-29 (2007).
- W7 Wilkening, M.H., W.E. Clements and D. Stanley. Radon 222 flux measurements in widely separated regions. pp.717–730 in: *The Natural Radiation Environment II* (J.A.S. Adams et al., eds.). CONF-720805-P2. National Technical Information Service, U.S. Department of Commerce, 1972.
- W8 WNA. World uranium mining production. World Nuclear Association. [Internet] Available from (<http://www.world-nuclear.org/information-library/nuclear-fuel-cycle/mining-of-uranium/world-uranium-mining-production.aspx>) on 06.04.2016.
- W9 WNA. Nuclear power in France (updated 31 March 2016). World Nuclear Association. [Internet] Available from (<http://www.world-nuclear.org/information-library/country-profiles/countries-a-f/france.aspx>) on 02.08.2016.
- W10 WNA. In Situ Leach (ISL) mining of uranium. World Nuclear Association. [Internet] Available from (<http://www.world-nuclear.org/info/Nuclear-Fuel-Cycle/Mining-of-Uranium/In-Situ-Leach-Mining-of-Uranium>) on 31.05.2015.
- W11 WNA. Supply of uranium. World Nuclear Association. [Internet] Available from (<http://www.world-nuclear.org/information-library/nuclear-fuel-cycle/uranium-resources/supply-of-uranium.aspx>) on 24.03.2015.
- W12 WNA. Processing of used nuclear fuel (updated November 2015). World Nuclear Association. [Internet] Available from (<http://www.world-nuclear.org/information-library/nuclear-fuel-cycle/fuel-recycling/processing-of-used-nuclear-fuel.aspx>) on 14.03.2016.
- W13 World Bank. Breakdown of electricity generation by energy source. The World Bank - World Development Indicators. [Internet] Available from (<http://www.tsp-data-portal.org/Breakdown-of-Electricity-Generation-by-Energy-Source#tspQvChart>) on 24.11.2015.
- Z1 Zeevaert, T., L. Sweeck and H. Vanmarcke. The radiological impact from airborne routine discharges of a modern coal-fired power plant. *J Environ Radioact* 85(1): 1-22 (2006).



## ANNEX C

# BIOLOGICAL EFFECTS OF SELECTED INTERNAL EMITTERS—TRITIUM



## CONTENTS

I. INTRODUCTION .....	245
II. SOURCES AND LEVELS .....	248
A. Natural sources .....	248
B. Artificial sources .....	248
III. PHYSICAL, RADIOLOGICAL AND BIOCHEMICAL CHARACTERISTICS .....	252
A. Physical characteristics .....	252
B. Radiological characteristics .....	252
C. Biochemical characteristics .....	253
IV. HUMAN EXPOSURE .....	255
A. Exposure of the public .....	255
B. Occupational exposure .....	258
V. BIODYNAMICS AND DOSIMETRY .....	259
A. Information on biokinetics and dosimetry of tritiated compounds .....	259
B. Overview of current biokinetic models for tritium .....	272
C. Intakes of tritium in relation to pregnancy and breast-feeding .....	281
D. Uncertainties in dose coefficients for tritium .....	284
E. Summary of biokinetic and dosimetric models .....	285
VI. BIOLOGICAL AND HEALTH EFFECTS .....	287
A. Non-radiological effects of tritium in biological systems .....	287
B. Deterministic effects .....	288
C. Stochastic effects of HTO in mammals .....	295
D. Effects of tritiated biochemical substrates .....	299
VII. RELATIVE BIOLOGICAL EFFECTIVENESS .....	304
A. Track structure considerations .....	305
B. RBE literature reviews and experimental studies .....	307
C. Factors affecting RBE values .....	308
D. Summary of RBE value determinations .....	309
VIII. EPIDEMIOLOGICAL STUDIES .....	316
A. Studies of occupational exposure .....	316
B. Studies of environmental exposure .....	320
C. Summary of epidemiological studies .....	321

IX. RESEARCH NEEDS .....	322
X. GENERAL CONCLUSIONS .....	324
XI. ACKNOWLEDGEMENTS .....	325
APPENDIX A: TABLES SUMMARIZING STUDIES OF OCCUPATIONAL AND ENVIRONMENTAL EXPOSURE TO TRITIUM .....	327
REFERENCE .....	341

## I. INTRODUCTION

1. The Committee has conducted an independent review of the scientific literature on the characteristics of tritium, its biokinetics and dosimetry within the human body for various physical and chemical forms and routes of intake into the body, radiobiological effects of tritium exposure, and epidemiological data relating to its impact on the health of workers and members of the public.

2. Tritium is a radioactive isotope of hydrogen (symbol  $^3\text{H}$ , but commonly represented by T). Chemically, it behaves like other isotopes of hydrogen (protium,  $^1\text{H}$ , the principal stable isotope, and deuterium,  $^2\text{H}$ , the other stable isotope). The word tritium is used here to mean the particular isotope of hydrogen irrespective of the chemical form in which it occurs.

3. Tritium occurs both naturally, mainly as a result of the interaction of cosmic-ray particles with the atomic nuclei of air molecules in the upper atmosphere, and as a consequence of the operation of nuclear reactors and other industries. Tritium in the environment and workplace is encountered predominantly as tritiated water (HTO) in liquid or vapour form.

4. Tritium emits low-energy beta particles with a short range in body tissues and, therefore, poses a risk to health as a result of internal exposure only following ingestion in drinking water or food, or inhalation or absorption through the skin. Unlike external penetrating radiation, such as X-rays and gamma rays, internal exposure to tritium has the potential to result in heterogeneous dose distribution within tissues and cells. Other factors that may affect the potential radiotoxicity of tritium include transmutation and isotopic effects. Transmutation is the term used for the formation of a new element by radioactive decay, which has the potential to adversely affect metabolic processes. Isotopic effects apply to low atomic mass elements such as hydrogen, for which tritium atoms with larger mass may replace the stable protium in cellular processes. Both effects are judged to be minor contributors to radiotoxicity when compared to the predominant effect of the energy deposition from beta particles emitted by tritium decay.

5. Five main chemical forms are of interest when considering the biological and health effects of internal exposure to tritium: HTO, organically bound tritium (OBT), tritiated biochemical substrates (including DNA precursors), insoluble compounds, and tritiated gases. OBT is the general term used to describe tritium that is non-exchangeably bound to carbon atoms within organic constituents of cells and tissues (e.g. proteins, polysaccharides, lipids).

6. Absorbed doses arising from the intake of tritium cannot be measured directly and recourse has to be made to the use of bioassay (such as the determination of tritium in urine) or to assessments based on environmental monitoring. Biokinetic models of the behaviour of tritium in the body are used to determine intake from such measurements and are also used together with dosimetric models to relate retention of tritium in body tissues to the time-course of dose delivery within tissues. For intake of tritium as HTO, distribution between organs and tissues and within cells is quite uniform, depending on their water content, and so the dose is uniformly delivered despite the short range of the low-energy beta particle emissions.

7. However, some organic substrates containing tritium concentrate in specific organs and tissues, and even within specific regions within cells. In such cases, the pattern of dose distribution is very different from that experienced following uniform exposure to external penetrating radiation or

incorporation of HTO, with heterogeneity of dose between organs and tissues, and potentially within organs and even within cells. For intake of tritiated nucleotides and nucleosides, for example, a small proportion has been shown to reach cells intact and may then be incorporated into cellular DNA, resulting in localized energy deposition [D5, N1].

8. There is also some tritium-containing radioactive material with low solubility in aqueous media, such as tritides of metals (e.g. Ti, Zr, Hf), tritiated luminous compounds, micro fragments of glass and carbon and beryllium particles contaminated with tritium. Such inhaled particles exhibit long-term retention in the lungs, leading to prolonged exposure of lung tissue to beta radiation.

9. The International Commission on Radiological Protection (ICRP) has used three main biokinetic models in the estimation of doses from compounds that contain tritium for protection purposes [18, I9, I10, I14, I15, I18]:

(a) A model for tritium absorbed to blood as HTO following either ingestion or inhalation, applied also to other tritiated compounds, including elemental hydrogen and methane, that partially convert to HTO after being taken into the body;

(b) A model for tritium absorbed to blood as OBT, mainly following ingestion in food, but also applied to inhalation of non-specified organic material and to ingestion or inhalation of some specific tritiated organic compounds;

(c) The generic ICRP models for the human respiratory tract, specifying absorption parameter values for inhalation of insoluble forms of tritium used in industry, including metal tritides.

10. The existing ICRP biokinetic and dosimetric models for tritium are currently being upgraded on the basis of recent biokinetic data, especially for recently developed physical and chemical forms of tritium. This work includes models for tritium as gases, HTO, organic substances and OBT, and material with low solubility.

11. Electrons with very low energy, including beta particles from  $^3\text{H}$ , have higher linear energy transfer (LET) values than electrons generated by the interaction of higher energy photons (e.g. from external gamma rays). This higher LET may result in greater effectiveness in causing cancer. The assessment of the effectiveness of different radiation in causing health effects relies on data on their relative biological effectiveness (RBE). RBE is an empirical quantity that depends on the biological system, the observed end points, the dose and the experimental conditions. In recent decades, several tens of experiments have been conducted using mammals (mostly mice) and their cells to determine RBE for tritium under various experimental conditions and considering a range of biological end points. However, only a small number of studies were performed to directly measure cancer induction in mammals.

12. Laboratory studies using animals have demonstrated that tritium, like other sources of radiation, can interfere with the development of the embryo or fetus, and can induce carcinogenic, heritable and reproductive effects and cell death. The use of high doses of tritium, for example, in the form of HTO or tritiated thymidine, has also been shown to induce acute radiation syndrome.

13. The dose and risk from some tritiated biochemical substrates and OBT is greater than that from HTO due to their longer residence in the body. However, there are few studies looking specifically at biological effects related to tritiated biochemical substrates and most of them use DNA precursors and amino acids. There is no appropriate ICRP biokinetic and dosimetric model for use in human risk assessment and radiation protection for tritiated nuclear acid precursors and there is a practical need for

the development of such models for intake of tritiated biochemical substrates, including nucleotropic forms even though the number of workers dealing with such forms of tritium is limited.

14. Most experimental studies on tritium were performed 20 to 30 years ago. While this work was competently performed at the time, it did not use modern scientific approaches and procedures that are often more sensitive and can use multiple approaches to test a single question. The application of modern techniques would be helpful in reinvestigating aspects of tritium dosimetry and effects, including fetal and embryo studies, and DNA damage analyses.

15. Workers may be subjected to wide-range occupational exposure to tritium in various chemical and physical forms. Usually, occupational exposure to tritium is low relative to other sources of exposure. However, historically there have been several cases of occupational exposure of workers (Russian Federation, Germany), mostly following accidents but also following chronic exposure to considerable quantities of tritium, resulting in haematological radiation syndrome [M15, O3, S12], including a few cases of radiation-induced death.

16. The principal source of quantitative information on radiation-induced cancer and other health effects in humans remains the epidemiological follow-up studies of the Japanese survivors of the atomic bombings exposed to external radiation [P12, P13, U11]. An important question is the extent to which these risk estimates are applicable to exposure from internal emitters, including tritium with its low dose-rate and low-energy beta radiation with heterogeneity of exposure between and within organs and tissues. Currently, little information on tritium-specific risks can be derived from epidemiological studies of tritium workers or members of the public potentially exposed to tritium, beyond the conclusion that tritium-specific risks have not been substantially underestimated.

17. The Committee has agreed to undertake a comprehensive review of the biokinetics, dosimetry and effects of selected internal emitters. The first radionuclide to be considered is the radioisotope of the element hydrogen, tritium. The main reasons for this selection are as follows:

- The potential for large scale production of tritium in connection with civilian and military fusion activities, as well as its creation as a by-product from operation of nuclear fission reactors, especially heavy water reactors;
- Exposure of workers and the public to various physical and chemical forms of tritium, including organic and substrates with low solubility, with a wide range of radiotoxicity that requires comprehensive scientific analyses;
- Professional and public concerns expressed between 2006 and 2010 regarding the radiotoxicity of tritium, which led to extensive review and data analysis in a number of countries, including Canada, France and the United Kingdom.

## II. SOURCES AND LEVELS

### A. Natural sources

18. Tritium was discovered in 1934 by Oliphant, Harteck and Rutherford [O4] and isolated in 1939 by Alvarez and Cornog [A2]; the production of tritium by natural processes was reported by Libby [L10]. There are three main sources of natural tritium: production in the atmosphere by galactic cosmic rays, production in the atmosphere by solar flare accelerated particles, and accretion from the sun. This natural production of tritium is estimated to occur at a rate of about 0.12 to 2.0 tritium atoms per square centimetre of earth surface per second, with the most probable values being close to 0.2 to 1.0 tritium atoms per square centimetre per second [J1, N2].

19. Tritium produced by natural processes is rapidly converted into HTO, which then joins the water cycle. Its concentration in continental surface water and throughout the oceans is about 400 Bq/m<sup>3</sup> and 100 Bq/m<sup>3</sup>, respectively. Humans, on average, ingest about 500 Bq of tritium each year, with a resulting average annual effective dose of about 0.01  $\mu$ Sv [U11].

### B. Artificial sources

#### 1. Nuclear weapon tests

20. In the mid-1950s and early 1960s, tritium was widely dispersed during the above-ground testing of nuclear weapons. Especially large quantities of tritium in elemental form and as tritium oxide were released in the environment in a series of hydrogen-bomb tests that started in 1952; their total explosive fusion yield was 328 Mt. The total amount of tritium released into the atmosphere from the testing of nuclear weapons from 1945 to 1980 was estimated to be 186,000 PBq [U11]. The quantity of tritium in the atmosphere from weapon testing peaked in 1963 and has since been decreasing.

21. Tritium is readily recycled in the biosphere and becomes homogeneously disseminated in the hemisphere where it has been released. The International Atomic Energy Agency (IAEA) runs a global network of 155 stations to measure tritium in precipitation [I1]. Measurements of tritium in drinking water in the United States in the early 1960s showed concentrations over two orders of magnitude higher than background levels that decreased with a half-time of about three years (figure I).



Figure I. Environmental tritium in surface water (pCi/L) in the United States in 1951–1975 [B15]

1 pCi/L = 0.037 Bq/L

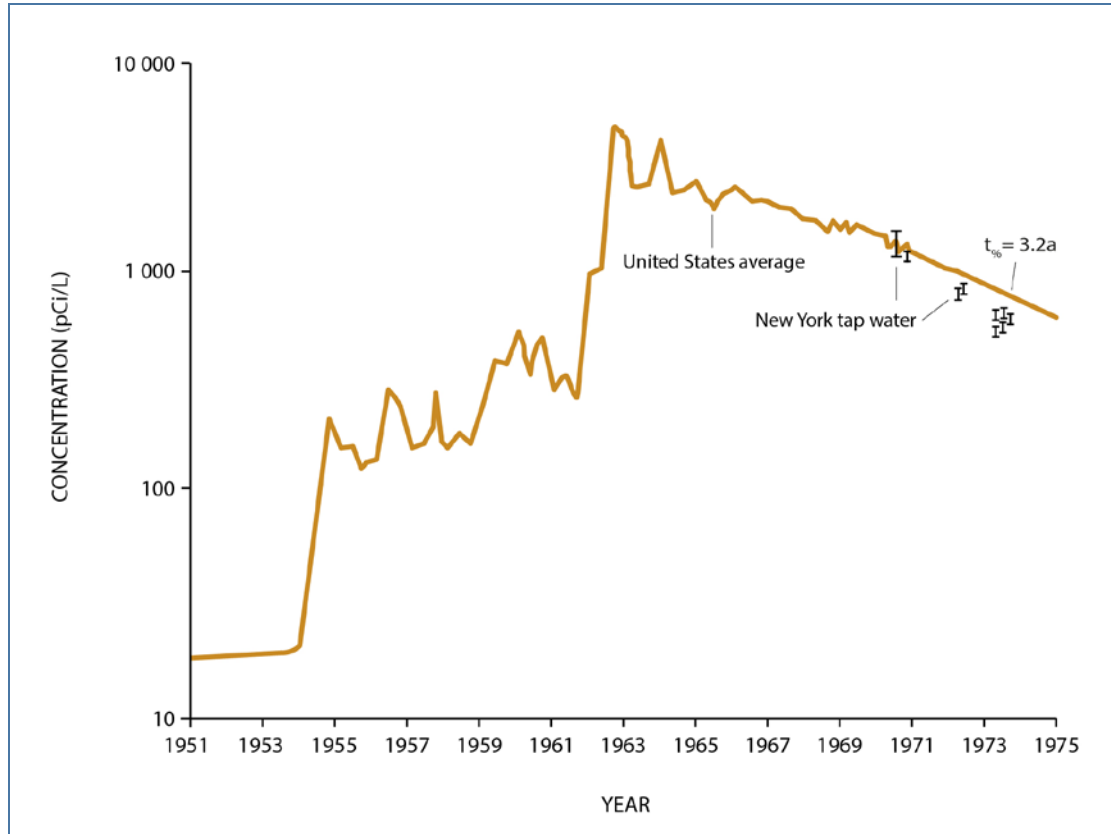

## 2. Production of tritium

22. In countries with developed nuclear technologies, tritium is produced in large quantities for military and peaceful purposes by means of irradiation with neutrons of lithium enriched with isotope  ${}^6\text{Li}$  at industrial nuclear reactors. Tritium can be released into the environment from operational tritium production facilities in the form of elemental hydrogen or tritium oxide with high specific activity.

23. Elevated levels of HTO were measured in lakes located in the area of the Mayak facility (Ozyorsk, Russian Federation) in 1982, 1986 and 2001–2003 by Chebotina and Nikolin [C12] and in 2009–2012 by Kazachenok et al. [K5, K6]. In the former measurement series, tritium concentration in lake water in 2001–2003 was inversely proportional to the distance from the Mayak facility (figure II). During the observation period 1982–2003, the HTO concentration in lake water decreased by a factor of 2 to 16 while during the same period its mean concentration in major Russian rivers went down by a factor of about 3, from 8 to 3 Bq/L [S20].

Figure II. Dependence of tritium concentration in lake water (Bq/L) in 2001–2003 on the distance (km) from the Mayak facility [C12]

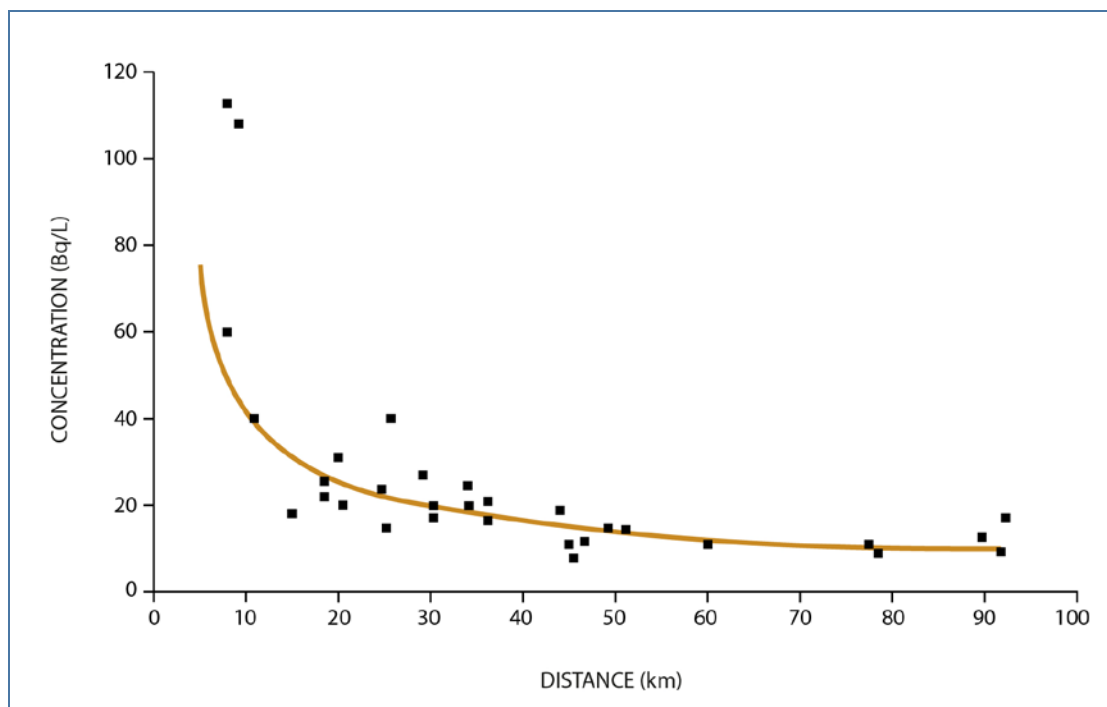

### 3. Operation of nuclear facilities

24. Tritium is produced in nuclear reactors by ternary fission, one triton per around 1 in  $10^4$  fissions of  $^{235}\text{U}$  induced by thermal energy neutrons and by neutron reaction with light elements such as boron, lithium and hydrogen (deuterium) [N2]. Tritium is produced in much larger quantities in heavy-water-moderated nuclear reactors through neutron capture by deuterium atoms.

25. Tritium is released into the environment from nuclear reactors, especially heavy water reactors, and spent fuel reprocessing plants, including waste storage and waste disposal sites. In the future, there is potential for significant releases during the operation of fusion reactors. Tritium is released predominantly as HTO or elemental hydrogen, partially converted by environmental biota to OBT. From 1998 to 2002, the global annual average releases of tritium to the atmosphere and to the aqueous environment from nuclear facilities were estimated to be 11.7 PBq and 16.0 PBq, respectively. The resultant average annual collective effective doses from these releases were estimated to be 25 and 10.5 person-Sv, respectively [I2, I3, U11].

26. In the vicinity of nuclear installations, especially near heavy water reactors, tritium activity in environmental compartments can be above background values. For example, while tritium (HTO) activity concentrations in air at background locations in Ontario, Canada, range from 0.01 to 0.08 Bq/m<sup>3</sup>, tritium in the vicinity of CANDU nuclear power plants (NPPs) range from 0.05 to 31 Bq/m<sup>3</sup>. Fish caught in the vicinity of NPP effluent discharges have HTO activity concentrations up to 50 Bq/L while in fish from background locations, it was less than 9 Bq/L [C23].

#### 4. Incidental releases from nuclear facilities

27. Large incidental releases of tritium from tritium production facilities have been reported to occur from Lawrence Livermore Laboratory, United States in 1970 and from Savannah River Plant, United States in 1974–1984 shown in table 1 [O2]. The released activity decreased with time from 11 to 0.3 PBq in early 1970s to 0.3 PBq in 1984. The chemical forms of the released tritium were predominantly elemental hydrogen (gas) or tritium oxide or their mixture. Monitoring has shown that elemental tritium was gradually converted in the environment to tritium oxide.

Table 1. Large incidental releases of tritium in the United States [O2]

Lawrence Livermore Laboratory (LLL) and Savannah River Plant (SRP)

Site	Year	Tritium release (PBq)	HTO (%)
LLL	1970	11	<1
SRP	1974	18	<1
SRP	1975	6.7	0.6
SRP	1981	1.2	>99
SRP	1983	2.1	1
SRP	1984	0.3	70

28. Elevated levels of tritium in the environment were also observed following major nuclear accidents—the Chernobyl accident in the USSR in 1986 and the Fukushima accident in Japan in 2011. In May 1986, tritium concentrations in precipitation collected in the Ukraine and the European part of the Russian Federation had increased by a factor of two–three compared with 1985, as had tritium concentration in river water [S20].

29. After the Fukushima accident, tritium concentrations in precipitation collected 170–700 km southwest from the Fukushima Daiichi Nuclear Power Station and in plant water collected in its vicinity were substantially elevated (up to a factor of a few tens) compared with pre-accident levels [K2, M4]. According to Povinec et al. [P11], the amount of tritium released and deposited over the north-west Pacific Ocean was in the range of 0.1–0.5 PBq.

#### 5. Other tritium-bearing facilities and commodities

30. Elemental tritium and tritiated luminous compounds are widely used in the luminizing industry, e.g. for illuminating watch and compass dials and as permanent warning lights. Metal plates with incorporated tritium are used in nuclear physics as targets for nuclear reactions, e.g. neutron production. Other metal plates with incorporated tritium are used as sources of air ionization in industry and agriculture. Tritiated biochemical substrates are produced at radiopharmaceutical facilities and then applied for diagnostic health examinations in hospitals, and research activities in medicine and biology.

31. Tritium used in such industrial, health care, research and other applications is partially released into the working environment, human habitat and natural environment and becomes incorporated in the bodies of workers and members of general public in various physical and chemical forms.

### III. PHYSICAL, RADIOLOGICAL AND BIOCHEMICAL CHARACTERISTICS

#### A. Physical characteristics

32. Tritium ( $^3\text{H}$  or T) is the heaviest radioactive isotope of hydrogen. The tritium atom has one proton and two neutrons in its nucleus and one electron. The binding energy of nucleons is 8.4 MeV, and the diameter of a tritium atom is 1.1 Angstroms. The dissociation energy,  $\text{T}_2$  to  $2\text{T}$ , is 4.59 eV; ionization energy,  $\text{T}$  to  $\text{T}^+ \text{e}^-$ , is 13.55 eV.

33. Tritium's physical properties are similar to those of common hydrogen ( $^1\text{H}$ ), which dominates in nature over tritium and the intermediate by mass, stable deuterium ( $^2\text{H}$  or D). Under ambient conditions, tritium is a colourless highly flammable diatomic gas with the molecular formula  $\text{T}_2$ . It is possible to make liquid tritium at atmospheric pressure by cooling it to below 25 K ( $-248\text{ }^\circ\text{C}$ ). Liquid hydrogen can be stored in insulated containers under pressure.

34. Tritium has a high coefficient of diffusion. It readily diffuses through porous substances such as rubber and can also diffuse through metal. Tritium, like common hydrogen, easily undergoes various chemical reactions depending on physical and chemical conditions. The prevailing form of tritium in nature is tritium oxide ( $\text{T}_2\text{O}$ ) or HTO.

35. Tritium figures prominently in studies of nuclear fusion because of its favourable reaction cross section and the large amount of energy (17.6 MeV) produced through its reaction with deuterium:

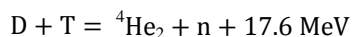

#### B. Radiological characteristics

36. The nucleus of the tritium atom is unstable and decays with the emission of a beta particle and an antineutrino to stable  $^3\text{He}$ . The antineutrino is of no biological significance because it does not interact with matter:

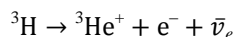

37. Tritium has a physical half-life of 12.3 years and, in the pure elemental state, a specific activity of  $3.56 \times 10^{14}$  Bq/g. Emitted beta particles are very low energy, mean 5.7 keV (90 fJ) and maximum 18.6 keV (300 fJ).

38. In water, the average track length of the beta particle is 0.56  $\mu\text{m}$  and the maximum track length is 6  $\mu\text{m}$ , which compares with a typical cell nucleus diameter of 6–15  $\mu\text{m}$ , while a cell has a diameter of 10–100  $\mu\text{m}$  [V1]. Tritium beta particles are completely absorbed by sheets of plastic, glass or metal. They do not penetrate dead layers of skin. However, following intake of tritium, beta radiation can irradiate internal organs. Within the body it gives a relatively low absorbed dose per disintegration compared with other beta-emitting radionuclides, but the ionization density of the electron is greater.

39. Radioactive decay of tritium atom also results in transfer of some recoil energy to a daughter  ${}^3\text{He}^+$  positively charged ion. This energy depends on the random dispersion angle between the emitted electron and antineutrino and comprises 1.0 eV as average and 3.3 eV as maximum [F2, G8]. This energy is insufficient for either daughter atom self-ionization (required energy of the order 10 keV) or tissue ionization (about 30 eV). Besides the recoil energy, the daughter  ${}^3\text{He}^+$  ion also carries excitation energy of about 11 eV that can influence the fate of the molecule to which the tritium atom was bound and result in its chemical transmutation and modification of its chemical properties.

## C. Biochemical characteristics

### 1. Tritiated water

40. Tritium is most commonly found in natural and working environments in the form of HTO, which has the same chemical properties as ordinary water. Water with a tritium activity of 1 Bq/L contains less than one tritium atom among  $10^{17}$  molecules of water. HTO can enter the human body by inhalation, skin absorption (liquid and vapour) [D3, P9], or ingestion of water or food [B14, I13]. Once inside the body, HTO diffuses freely and rapidly across cellular membranes, and reaches equilibrium throughout the total body water pool [H12]. HTO is excreted via urine, faeces, sweat, and breath [N1]. Since HTO quickly reaches equilibrium with the water in the body and is distributed uniformly among all soft tissues, the concentrations of HTO in sweat, sputum, urine, blood, perspiration, and exhaled water vapour are considered to be equal [H12].

### 2. Tritiated gases

41. Tritiated elemental hydrogen (HT or  $\text{T}_2$ ) is relatively inert in biological systems and has a very low uptake into body fluids and tissues [H12]. Humans are mostly exposed to HT by inhalation or skin contact with contaminated surfaces. A small fraction of inhaled HT is converted to HTO in the human body. The primary sources of HT are tritium production and processing facilities (such as those involved in making gaseous tritium light sources), tritium recovery facilities, and nuclear fuel reprocessing facilities. HT is readily converted to HTO in the environment, with soil microorganisms playing an important part in this process [A3].

42. Tritiated methane ( $\text{CH}_3\text{T}$ ) is relatively inert in biological systems. Humans can be exposed to  $\text{CH}_3\text{T}$  by inhalation in workplaces or in the public domain following biochemical degradation of OBT in the environment. Because of the low solubility of methane in body fluids, the radiological implications of inhaling  $\text{CH}_3\text{T}$  are mostly determined by its oxidation to HTO and biochemical conversion to OBT in the human body [P5].

### 3. Organically bound tritium

43. Because tritium atoms are exchangeable with normal hydrogen atoms, a fraction of the tritium absorbed by plants or animals can become incorporated into organic compounds such as carbohydrates, fats, proteins, and collagen: this is referred to as OBT<sup>1</sup>. Animals, including humans, ingest OBT and form OBT from HTO within their tissues [D5, K14].

44. A tritium atom in OBT attached to a carbon atom is essentially fixed until the compound is metabolized (i.e. the tritium is non-exchangeable). However, a tritium atom attached to an oxygen, sulphur, nitrogen or phosphorus atom is readily exchangeable with hydrogen in water and is not considered as OBT in this annex [D5, R11, S1] or specifically qualified as exchangeable OBT [K14]. OBT exhibits longer retention times in the body than HTO.

### 4. Tritiated organic substances

45. A broad spectrum of organic substances labelled with tritium, including biochemical substrates, are produced and used widely in research and for other purposes. Workers may be exposed by inhalation or through skin contamination, and also by inadvertent ingestion. In the human body, labelled biochemical substrates (e.g. amino acids, DNA precursors, glucose, hormones) may be metabolized with partial loss of tritium label converted to HTO, or be incorporated into biological macromolecules as OBT [B11, H12]. Foreign organic compounds (such as organic solvents) are usually rapidly excreted from the body in urine and faeces [B8].

46. Labelled DNA precursors (e.g. <sup>3</sup>H-thymidine, <sup>3</sup>H-deoxycytidine) belong to a special group that, in the mammalian body, are partially degraded to HTO and partially incorporated into the DNA of dividing cells, and thereafter selectively expose the nuclei of proliferating cells to beta radiation [D5, N1].

### 5. Metal tritides and other low soluble forms of tritium

47. Tritiated compounds with low solubility, which are widely produced and used in industrial or research facilities, include luminous compounds (as powders), particles of metal tritides that are used as accelerator targets or as ionization sources in industry and agriculture, and carbon, beryllium and tungsten dust, micro-fragments of glass contaminated with tritium used in fusion experiments. Airborne particles with insoluble tritium are inhaled by workers and, depending on their dimensions and respirability, deposited in the respiratory tract. Following inhalation, such substances can remain in the pulmonary region of the lungs and expose tissues to both beta radiation and, to a lesser extent, to bremsstrahlung.

48. Although insoluble particles are largely retained in lung tissues, transported by macrophages to regional lymph nodes, or escalated from the lungs by mucociliary clearance, some dissolution will occur and a proportion of their tritium content will be removed and absorbed to blood as HTO. When luminous powder produced from zinc sulphide granules coated with a thin layer of high activity tritiated polymer is inhaled, some tritium is detached from the polymer and absorbed to blood as low molecular organic foreign compounds that are rapidly excreted from the body in urine and faeces [B8, B11, B14].

---

<sup>1</sup> OBT in biological tissues is carbon-bound tritium that was originally formed in living systems through natural environmental or biological processes from HTO (or HT via HTO). OBT is not exchangeable with hydrogen in water.

## IV. HUMAN EXPOSURE

### A. Exposure of the public

#### 1. Tritiated water in global water cycle

49. The Committee [U9] has estimated worldwide average annual individual effective doses mainly from data on ingestion of the globally dispersed HTO created as a result of fallout from above-ground nuclear weapon testing (figure III) [B25, U9]. The doses received from the inhalation of  $^3\text{H}$  are negligible in comparison with those received from ingestion. The derivation of these doses is largely based on environmental measurements and is described by the Committee in its UNSCEAR 2000 Report [U9], Bouville et al. [B25] and Bennett [B16]. The background concentration of tritium in humans is calculated from an average of the concentrations in the sources of water ingested, assumed to be 33% from the atmosphere, 53% from fresh water, 13% from groundwater and 0.7% from ocean surface water (through fish) [B25, N2].

50. The largest annual doses from tritium in fallout were received by the world population during the period of intense nuclear weapon testing during the late 1950s and early 1960s, before the Limited Test Ban Treaty of 1963. The peak global average annual effective dose from tritium in fallout was  $7.2 \mu\text{Sv}$  in 1962. Since the majority of atmospheric nuclear weapon tests during that period took place in the Northern Hemisphere, average doses from tritium were greater in the Northern Hemisphere than in the Southern Hemisphere. Generally, tritium follows the global water cycle: a large proportion is transferred to the oceans within a few years of production and a very small fraction is ingested by humans [U9].

Figure III. Worldwide average annual individual effective dose in 1950s–1990s from the ingestion of tritium produced in atmospheric nuclear weapon testing [B25, U9]

Dashed line is for dose from natural tritium

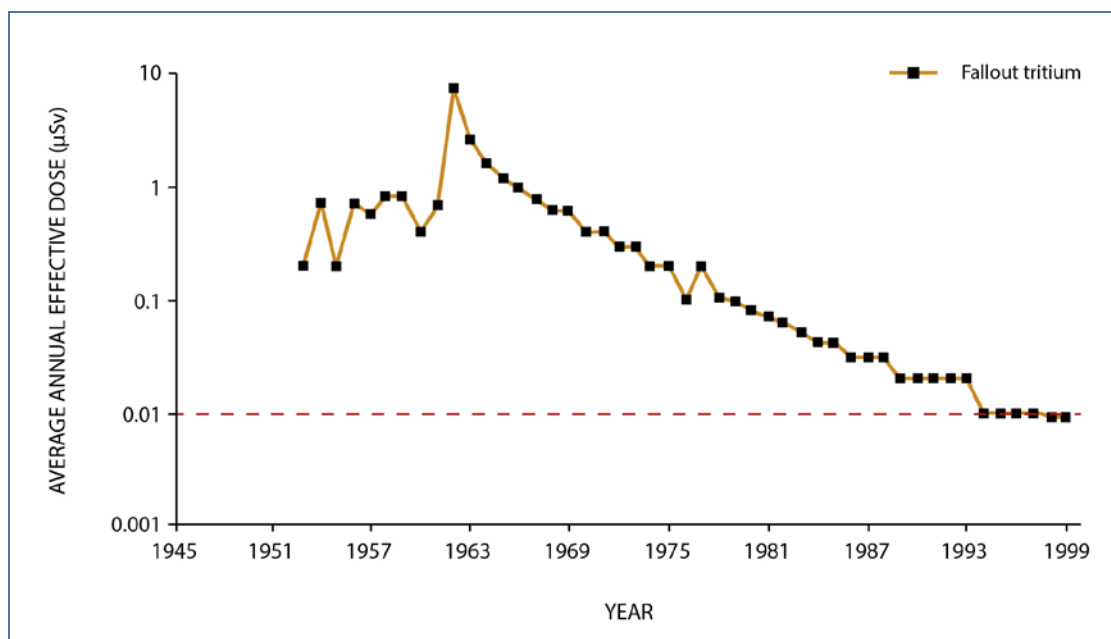

## 2. Local exposure of the public from nuclear facilities

51. Tritium released from nuclear facilities, especially from those operating with large amounts of tritium (i.e. tritium production facilities, heavy water reactors or reprocessing plants) may enter the bodies of people residing in the vicinity in drinking water or via inhalation. In these conditions, human doses caused by local intake of environmental tritium are usually larger than those caused by global tritium levels common in neighbouring areas with no facilities releasing tritium.

52. Measurements of tritium (HTO and OBT) in environmental media are carried out routinely in the vicinity of Canadian nuclear facilities. These measurements allow estimation of doses to members of the public from all exposure pathways (e.g. inhalation, skin absorption, ingestion of food and drinking water). In 2006, annual tritium doses to members of the public living in the vicinity of NPPs were less than 2.5  $\mu\text{Sv}$  whereas they were slightly higher in the vicinity of two facilities manufacturing gaseous tritium light sources (GTLS). The annual tritium doses of respective critical groups for the two GTLS facilities were 15 and 67  $\mu\text{Sv}$  [C23].

53. Kim and Han [K13] studied environmental radiation conditions in 1992–1993 around the Wolsong NPP, Republic of Korea, for a CANDU-6 heavy water reactor that had been operational since 1983. Activity concentrations of HTO and OBT were analysed in food samples collected within 1–15 km of the reactor site and HTO was collected from the air in some locations. In water samples extracted from rice, Chinese cabbage, radish and pumpkin, HTO concentration was in the range of 3–100 Bq/L and that in combustion water obtained from organic parts of vegetables was 4–130 Bq/L, both inversely proportional to the distance from the site. The ratio of tritium concentration per unit hydrogen mass in OBT to that in free HTO was in the range of 1.0–2.8, with an average of 1.35. On the basis of monitoring data, the authors assessed the annual effective dose for adult members of the public to be in the range of 1.3  $\mu\text{Sv}$  in a radius of 0–1.6 km to 0.15  $\mu\text{Sv}$  at 8–16 km. Although both values are much lower than the background dose, they are substantially higher than the annual dose from environmental tritium to the Korean public residing away from NPPs, assessed by Yoon et al. [Y7] from urine samples of 50 persons to be about 2 nSv.

54. In 2008, Chebotina and Nikolin [C13] measured elevated tritium concentrations in the urine of 45 residents of five towns located in the vicinity of the Mayak facility (figure IV). The average concentrations, in the range of 100–800 Bq/L, correlated inversely with the distance between the town and the Mayak facility. Those values are much higher than tritium concentrations in potable water measured in the area in the 2000s, indicating inhalation as a possible intake pathway. The measured concentrations of tritium in urine correspond to average annual effective doses incurred by the residents of five towns in 2008 in the range of 3–14  $\mu\text{Sv}$ .



Figure IV. Average concentration of tritium in 2008 in urine of residents of towns located in the area of the Mayak facility [C13]

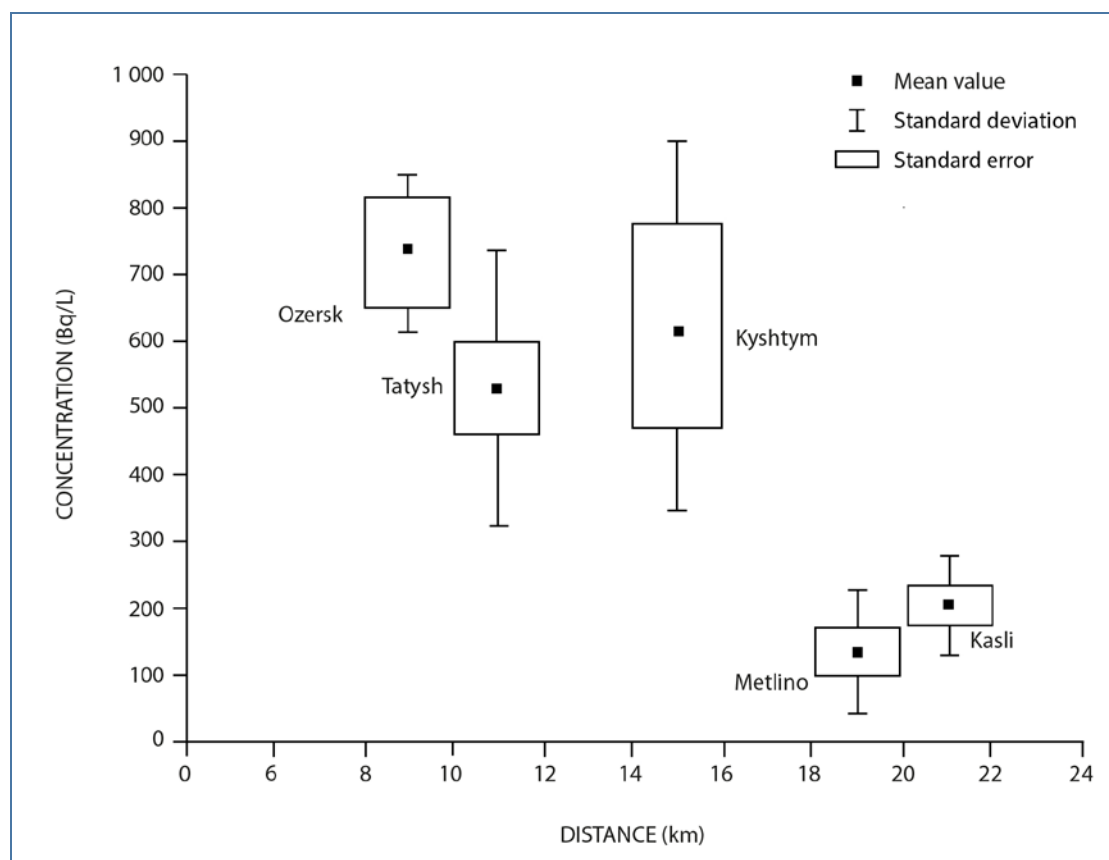

### 3. Organically bound tritium in human tissue

55. Very few authors have directly measured tritium content in human tissue. Bogen and Welford [B21] for example have summarized results of tritium measurements in the United States' environment carried out in 1960s to early 1970s in non-equilibrium conditions caused by termination of nuclear weapon tests in 1963 and continued radioactive fallout (decreasing with time) from the stratosphere. They sampled water vapour from the air, tap water, soil, vegetation, food, animal and human tissue and they measured HTO in water distilled from the samples and OBT in water from combustion of dried samples. Both sets of data were presented in terms of HTO activity concentration in water. In all links of the ecological chain up until 1973, the tritium specific activity in the OBT fraction was higher than that found in the free water fraction. The ratio of specific activities OBT/HTO decreased by a factor of about 1.5–2 from each trophic level: soil 6–8, vegetation 3–4, animal 2–3 and human 1.5–2. Those patterns can be interpreted by slower clearance of OBT compared to HTO from various organisms of the trophic chain and their residues (soil organic matter) in conditions of decreasing HTO concentration in the environment, as was the case in the 1970s.

56. Ujeno et al. [U3] measured tritium in tissue water distilled from samples of human organs and tissues (brain, lung, liver, kidney and muscle) collected by staff of Kyoto University during forensic autopsy of eight dead bodies. The tritium concentration in water from various organs and tissues was similar and not affected

by sex or age. The average HTO concentration in tissue water was  $2.5 \pm 0.7$  Bq/L, which was similar to that measured in tap water, rain water and water distilled from local food.

57. Hisamatsu et al. [H13, H14] presented the results of tritium measurements in organs and tissues collected from 11 human cadavers (10 males, one female, mean age  $\pm$ SD =  $46 \pm 16$  year), who died suddenly in 1986 at Akita Prefecture in northern Japan. They measured tritium concentrations in free water (HTO) distilled from human samples (brain, liver, lung, heart, kidney, blood serum and whole blood) and in combustion water obtained by combustion of dried samples in oxygen atmosphere. The mean tritium concentrations in free water from seven diverse organs and tissues were similar, with a range of 1.5–1.9 Bq/L and average of 1.6 Bq/L. Mean tritium concentration in combustion water of various organs/tissues varied in the same range, average 1.7 Bq/L. The ratio of OBT/HTO tritium concentrations in human tissue varied between 0.95 and 1.3 with an average of 1.1. Tritium concentrations in local food sampled in 1985–1987 were also reported. Free water concentration in six samples of the total human diet varied between 1.4 and 2.2 Bq/L and combustion water varied in the range of 1.7–2.2 Bq/L. Their ratio varied between 0.9 and 1.6 with an average value of 1.2. Thus, in equilibrium conditions of low-level intake of environmental tritium, no differences in tritium concentrations were revealed between various human organs and tissues, between diet and human tissue, and between free water tritium and OBT.

#### 4. Measurements of environmental tritium

58. The measurement of environmental tritium in its various forms as gases or vapours (HT, HTO, organic molecules), liquids (HTO or OBT in solution) and solids (OBT, hydrides) is a key step for dose assessment and evaluation of health and environmental risks. Sampling, storage and treatment are important points in the analytical procedure for tritium. The final form of tritium for analysis is usually water, and low concentrations of tritium in water (few Bq/L) are currently measured either by gas proportional counter or by liquid scintillation counter. They can also be determined indirectly using a sensitive mass spectrometer, measuring the amount of the decay product, helium-3, formed in a water sample in a closed vessel during a given period [W8].

59. Reference water that is virtually tritium-free is used as calibration blanks for the analytical system and a recent comparison of these water sources gave results ranging from 0.004 to 0.17 Bq/L [F9]. Analytical procedures have been developed to measure OBT [B2] and respective standards are under development. Recent studies of the speciation of tritium as OBT are investigating variations in the hydrogen content of different forms and identifying compounds solubilized in the samples during labile exchange [B1].

## B. Occupational exposure

60. In working environments, tritium is present in various physical and chemical forms depending on the production processes. Working environments may contain tritium in a variety of different chemical forms, including HTO, elemental hydrogen, organic solvents, airborne particles of metal tritides (e.g. Ti, Zr, Er), tritium contaminated glass and dust particles, luminous compounds, and labelled biochemical substrates (e.g. amino acids, DNA precursors, glucose, hormones) [B11, H16, I2, I3, J1].

61. Occupational exposure to tritium is usually low relative to other sources of exposure. For example, in 2006 average annual tritium doses for NPP workers in Canada ranged between 0.07 and 0.26 mSv, which represented between 14 and 29% of the total effective dose. In the same year, workers employed at two Canadian GTLS manufacturing facilities had annual tritium doses of 0.19 and 0.3 mSv [C23].

## V. BIODYNAMICS AND DOSIMETRY

62. Biokinetic models describe the time-dependent deposition and translocation of radionuclides in the body and the rates at which they are removed from the body. Biokinetic models are used to calculate the number of nuclear transformations of radionuclides in each source organ during a specified period following an intake. Dosimetric models are then used to calculate the absorbed doses to specific organs and tissues (referred to as target organs) per nuclear transformation of radionuclides in each source organ (i.e. each site of radionuclide deposition or transit in the body).

63. For protection purposes, ICRP calculates values of committed effective dose as a doubly weighted sum of organ and tissue doses—first, adjustment to take account of the relative effectiveness of different radiation types in causing stochastic effects using radiation weighting factors ( $w_R$ ), and second, adjustment for differences between organs and tissues in their contribution to total detriment from stochastic effects using tissue weighting factors ( $w_T$ ) [I23].

64. Because the range of the beta radiation emitted by tritium is short, all the radiation energy is generally assumed to be absorbed in the tissues and organs in which the tritium decays. Therefore, organ or tissue dose from tritium radiation is entirely determined by a relevant biokinetic model and not by radiation transport in the body. The biokinetic model for tritium depends on the type of tritiated compound taken into the body, as this dictates its deposition, translocation, retention and excretion.

65. In animal studies, the absorbed dose in tissue resulting from an acute administration of tritium can be calculated using information on the initial activity concentration of tritium in the tissue and the rate of removal of tritium from that tissue arising from biological processes and radioactive decay. This section presents the basis for the biokinetic models used for the intake of tritiated compounds by inhalation, ingestion or absorption through the skin. Examples of dose coefficients (committed effective dose per unit activity taken into the body) for tritium calculated with the various biokinetic models are provided.

### A. Information on biokinetics and dosimetry of tritiated compounds

#### 1. Tritiated water

##### (a) *Early biokinetics of HTO in mammals*

66. Tritiated water can enter the human body via ingestion of food and drink and—mostly for occupational exposure—by inhalation of HTO vapour or direct absorption through skin exposed to water or water vapour. Following ingestion, absorption from the alimentary tract into the bloodstream is complete within a time range from a few minutes to some tens of minutes. Following inhalation, almost the entire amount of inhaled HTO vapour is absorbed very rapidly from the respiratory tract into the bloodstream [B7, P9]; absorption through skin provides an additional common route of entry into the bloodstream [D3, O6, P9].

67. Following uptake to blood from the alimentary or respiratory tracts or through the skin, HTO is transported by the circulatory system to all the body organs and tissues and diluted uniformly in body

water. This process takes from a few hours to some tens of hours. A small fraction of tritium from HTO (0.5 to 4%) exchanges very rapidly with hydrogen in organic molecules as OH, NH and SH bonds throughout body tissues. Another small fraction (from less than 1 to 3% in humans) is gradually converted to OBT as a result of biochemical processes, i.e. CH bonds in organic molecules [B8, H12, P9].

68. The absorption of HTO through the skin from either the vapour or liquid phase has been investigated by several authors. DeLong et al. [D3] exposed mice, rats and human adult volunteers to HTO vapour in air. Animals were sacrificed following exposure. Urine and blood samples were collected from human subjects for 48 hours after the end of exposure. Absorption rates of HTO, calculated from measurements of tritium in blood and total body water, suggested that a delay occurred in the distribution of the absorbed HTO. The absorption rate of HTO through the skin was the same whether the skin was covered with a cloth (cotton) or uncovered. It was also proportional to the water vapour pressure. This suggested a single diffusion mechanism for percutaneous absorption. However, the absorption rate for the vapour phase was larger than could be accounted for by diffusion due to vapour pressure alone, perhaps as a result of capillary action. The absorption rate increased with increasing skin temperature. DeLong et al. [D3] and Pinson and Langham [P9] concluded similarly that the quantity of HTO entering the body through the total skin, when exposed to an atmosphere containing a given activity per unit volume, would be about equal to that entering through the lungs. Osborne [O6] exposed volunteers to HTO in air and measured the tritium activity in urine, showing a correlation between skin absorption rate and skin temperature.

### *(b) Long term biokinetics of HTO in mammals*

69. Several studies have examined the biological half-time of HTO in a total of about 400 adults by measuring tritium activity concentrations in urine. Butler and Leroy [B28] found this parameter to vary with the amount of water ingested (decreasing with increasing water intake rate), with the ambient temperature (decreasing with increasing ambient temperature) and with age (decreasing with increasing age in adults). Their study, based on 310 cases of HTO intake, showed that the biological half-time of HTO varied from about 4 to 18 days, with a mean of 9.5 days. During the warmer months, the average half-time was lower; the difference being attributed to increased water intake. Other studies, based on fewer cases, showed similar results [H12]: from 6 days for 8 cases [R16], to 12 days for 5 cases [B7]. In a few cases of accidental intake of large amounts of HTO, the excretion rate was accelerated with diuretics and increased intake of fluids (e.g. [S2, T14]). The ICRP model uses a biological half-time of 10 days for HTO and 40 days for OBT formed from HTO in the body of adults [I8, I9, I10, I14, I17].

70. A number of studies have reported evidence for the presence of a second exponential component of tritium activity concentration in human urine associated with the formation of OBT from HTO and its subsequent removal. The biological half-time for OBT removal mostly ranged from 23 to 104 days (mean 59 days) and its contribution to total excretion in 17 study subjects varied between 0.01 and 0.7% (mean 0.2%) [B7, H9, L4, S2, S17, T14]. A value of 40 days, based on carbon turnover in the body, was adopted by ICRP [I13]. This was derived from the ratio of reference values for the body content of carbon (16 kg) and daily carbon intake (0.3 kg) for adults [I7].

71. Some studies have reported an even longer component for the removal of tritium from the body (e.g. [M15, M16, S2]). However, the parameters of this component as derived from data obtained on five subjects occupationally exposed to either HTO or tritiated luminous compounds are very uncertain. Such a component would contribute in only a minor way to tissue doses, as it represents less than 1% of total OBT. The biological half-times of tritium following acute intake of HTO by adults reported by various authors are shown in table 2.

Table 2. Biological half-times of tritium in humans following acute HTO intake

Study	Number of cases	Biological half-time (days)		
		Compartment 1 (body water)	Compartment 2 (organically bound)	Compartment 3 (organically bound)
Pinson and Langham [P9]	9	11.3	—	—
Foy and Schnieden [F10]	10	5–11 (mean: 7.5)	—	—
Wylie et al. [W9]	7	6.4–12.1 (mean: 8.5)	—	—
Butler and Leroy [B28]	310	4–18 (mean: 9.5)	—	—
Osborne [O6]	30	6.4–14.4 (mean: 10.5)	—	—
Snyder et al. [S17]	1	8.7	34	—
Sanders and Reinig [S2]	1	6.1 <sup>a</sup>	23	344
Minder [M15]	1	—	10–30	139 to 230
Lambert et al. [L4]	1	9.1 <sup>b</sup>	36	—
Moghissi et al. [M16] <sup>c</sup>	3	—	21 and 26	280, 550±140, 350±190
Henry [H9]	1	7.5	63	—
Balonov et al. [B7]	5	11–13 (mean: 11.9±0.3)	39 to 76 (mean: 51±7)	—
Trivedi et al. [T14]	8	6.2–12.8 <sup>d</sup> (mean: 8.4)	58–104 (mean: 74±18)	—

<sup>a</sup> Oral diuretic administered from day 3–35 post-intake.

<sup>b</sup> HT/HTO acute intake.

<sup>c</sup> Data for three tritium luminous dial painters collected 6–10 months after termination of employment.

<sup>d</sup> During the initial period when the exposed individuals increased fluid intake one month post-intake, the biological half-time varied from 5.0 to 8.1 days with a mean of 6.3 days.

72. The partitioning of HTO and OBT after intake of HTO was examined by Takeda and Kasida [T1] as part of a study of the biokinetics of HTO in rats. These investigators found that “initially, the ratio of tissue-bound tritium to total tritium was about 3% in the kidney and 1–5% in other tissues.” Measurements of tritium in human tissue are generally unavailable, but information can be derived by biophysical modelling using long-term measurements of tritium in urine or, in some cases, blood samples. The published data from the six studies [B7, H9, L4, S2, S17, T14] are available for such analysis (table 2). Additional information can be derived from tritium measurements for organic components of urine (urea) or blood (proteins, dehydrated cells). However, the number of reliable measurements is limited [L4, R16, T16] and their representativeness with regard to tritium content in organs and tissues is questionable.

73. The long-term retention of tritium in the human body as shown in figure V was modelled by several authors as linear recurrent two-compartment models with transfer of tritium from HTO to OBT (synthesis of biomolecules with OBT) and subsequent catabolic loss (degradation of biomolecules with OBT) with all tritium excretion as HTO [B7, S17, T14]. Using this approach, the peak OBT activity

was calculated by Balonov and Chipiga [B6] from the data of the six studies referred to above [B7, H9, L4, S2, S17, T14]. The peak OBT activity was estimated to be reached in 16–38 days (mean  $26 \pm 5$  days) after a single HTO intake and accounted for 0.1–1% (mean  $0.4 \pm 0.2\%$ ) of the initial intake of tritium. Balonov and Chipiga estimated the contribution of OBT to total soft tissue doses after intake of HTO using 17 available data sets and obtained values of 1.8–4.6% (mean  $3.0 \pm 0.9\%$ ) [B6]. It is notable that the contribution of OBT to the total dose was estimated to be similar in nine subjects with relatively low previous occupational tritium intake [H9, L4, S2, S17] or in five volunteers with no previous tritium intake [B7] ( $3.0 \pm 0.9\%$ ) and in eight workers at a Canadian heavy water reactor ( $3.0 \pm 0.8\%$ ), indicating that the contribution of previous chronic HTO intake by the workers was insignificant.

Figure V. Schematic two-compartment recurrent model of tritium biokinetics following HTO intake in the body [B7, S17]

$I(t)$  is HTO intake rate (Bq/day);  $W(t)$  is tritium activity in the body as HTO (Bq);  $B(t)$  is tritium activity in the body as OBT (Bq);  $U(t)$  is tritium activity excreted from the body as HTO (Bq);  $\alpha$ ,  $\beta$  and  $\gamma$  are transfer rate constants ( $\text{day}^{-1}$ )

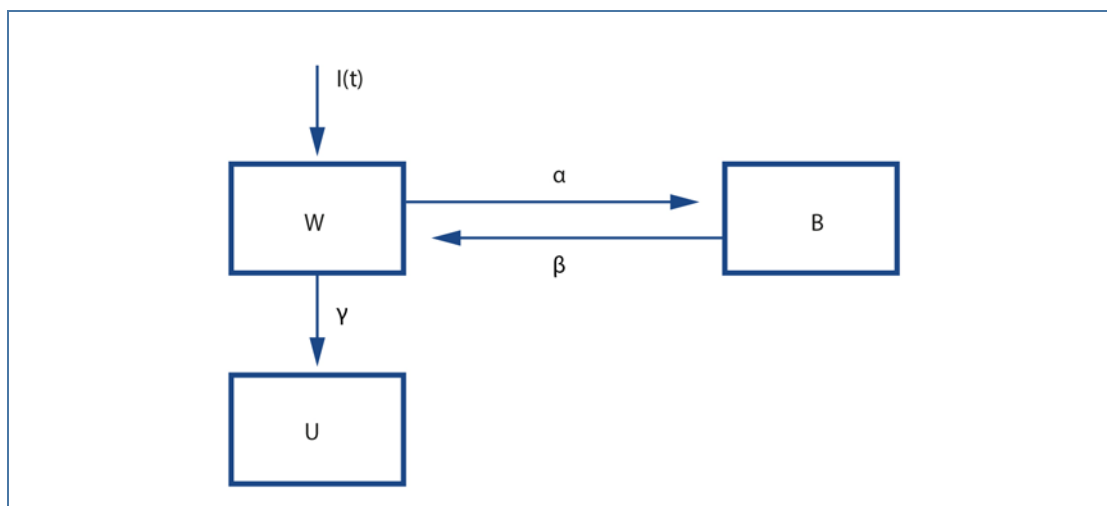

74. Trivedi et al. [T14] assessed the contribution of OBT to effective dose following acute intake of HTO by calculations based implicitly on a simpler linear two-compartment model with no transfer of tritium from HTO to OBT. Instead, it was assumed that some fraction of HTO taken in was instantly converted to OBT that was gradually degraded to and excreted as HTO (figure VI). The contribution of OBT to the effective dose assessed with this model was 3–9% (mean  $5.3 \pm 2.1\%$ ) for 15 subjects [B7, H9, I14, S17, T14] excluding data from Rudran [R16] obtained on workers occupationally exposed to tritiated luminous compounds. In another study by Trivedi et al. [T16] the tritium concentrations in urine and blood samples both as HTO and OBT for six workers chronically exposed to low levels of tritium were measured. The activity concentration of OBT per gram of hydrogen in OBT from urine and blood samples (their ratio was  $0.95 \pm 0.25$ ) was assumed to be equal to that in body tissues. By means of a simple equilibrium model, they calculated the contribution of OBT to the total dose to be equal to 4.7–9.9% (mean  $6.9 \pm 3.1\%$ ) for the six workers. This is in good agreement with the previous results from 15 subjects with acute intake of HTO.

75. The estimate of Trivedi et al. for the contribution of OBT to dose following acute intake of HTO (figure VI) is 1.8 times greater than that obtained by Balonov and Chipiga using a more physiologically realistic model (figure V); it does not account for the gradual bioaccumulation of OBT and assumes its instant formation from HTO. A similar conservative approach is used by the ICRP model for HTO (see also figure VIII) which is applied for radiation protection purposes [I14]. According to this model, 97% of HTO absorbed to blood is distributed in body water ( $T_{1/2}=10$  days in adults) and 3% is instantly

converted to OBT ( $T_{1/2}=40$  days in adults); the contribution of OBT to the effective dose in the ICRP model is about 9% under assumption of uniform OBT distribution in organs and tissues.

Figure VI. Schematic two-compartment model of tritium biokinetics following HTO intake in the body [T14]

$I(t)$  is HTO intake rate (Bq/day);  $x$  is fraction of tritium instantly converted to OBT (dimensionless);  $W(t)$  is tritium activity in the body as HTO (Bq);  $B(t)$  is tritium activity in the body as OBT (Bq);  $U(t)$  is tritium activity excreted from the body as HTO (Bq);  $\beta$  and  $\gamma$  are transfer rate constants ( $\text{day}^{-1}$ )

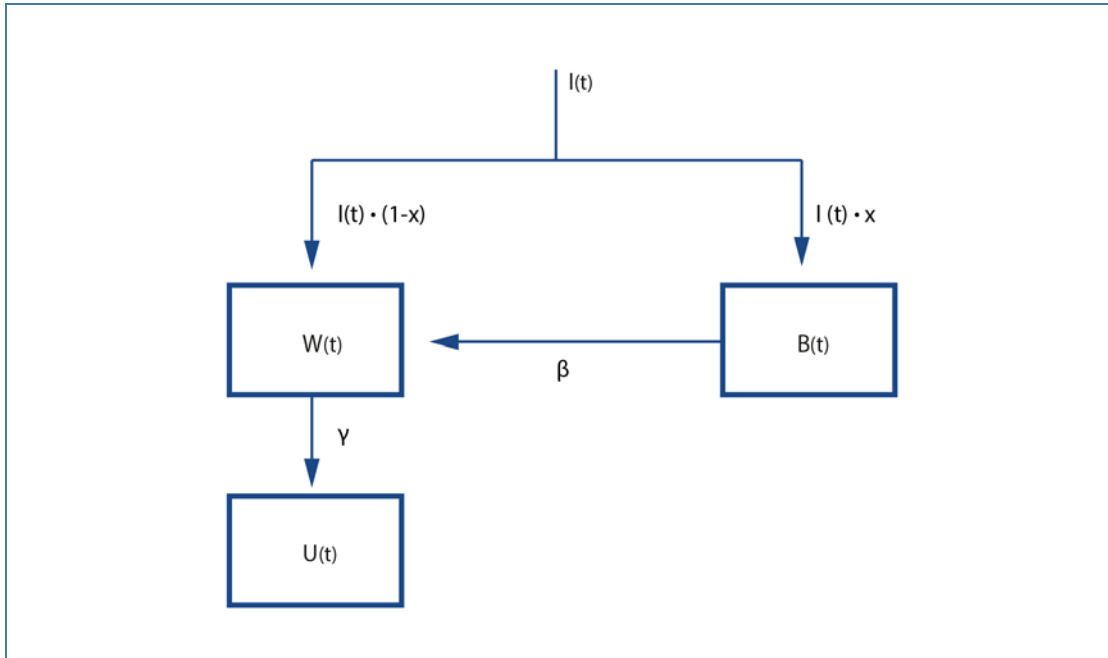

76. Other authors [H12, J3, N1, S2, T9] have used the limited available human data to develop a three-compartment model of tritium retention following intake of HTO. The results showed considerable variation, both in the observed biological half-times and in the proportions of tritium entering OBT compartments. The model parameters suggested by Taylor [T9] for adults are shown in table 3. The resulting committed effective dose per unit intake of HTO by adults, on the basis of this model, is  $1.7 \times 10^{-11}$  Sv/Bq. The current ICRP dose coefficient for HTO is  $1.8 \times 10^{-11}$  Sv/Bq [I15].

Table 3. Parameter values for HTO model proposed by Taylor [T9]

<i>Model component</i>	<i>Distribution (%)</i>	<i>Biological half-time (days)</i>
HTO	99	10
OBT <sup>a</sup>	0.98	40
OBT <sup>b</sup>	0.02	350

<sup>a</sup> Short-term OBT compartment.

<sup>b</sup> Long-term OBT compartment.

## 2. Inhalation and skin absorption of elemental tritium gas

77. Tritiated elemental hydrogen (HT) is only slightly soluble in body fluids and has a much lower uptake into biological systems than HTO. After inhalation, most of the HT is exhaled, but a small fraction is dissolved in body fluids and is then oxidized to HTO by anaerobic bacteria in the gastrointestinal tract, the only known biological site of HT oxidation [I6].

78. The ICRP based its assessment of the effective dose resulting from the inhalation of HT primarily on exposure of the lungs, as opposed to exposure of the skin. Oxidation to HTO in vivo was not considered [I9]. The absorption of HT through the skin appears to be negligible and it does not convert to HTO on contact with the skin [H12].

79. The studies of Pinson and Langham [P9] and Peterman et al. [P3, P4] found that exposure to HT resulted in excretion of HTO in urine, and that the HTO, formed from the oxidation of HT, was retained in the body and excreted with the usual biological half-time of about 10 days. About 0.01% of the HT inhaled by human volunteers was converted to HTO in the body [P3, P4, P9].

80. Using their biokinetic models for HT and HTO and data from studies with human volunteers, Peterman et al. [P3] concluded that the effective dose from inhaled HT was dominated by two roughly equal contributions: the effective dose resulting from exposure of the lungs to HT in inhaled air, and the effective dose resulting from exposure to HTO caused by the oxidation of HT. The current dose coefficient for inhalation of HT given by the ICRP Publication 68 [I15] is based on the work of Peterman et al. [P4] and its human respiratory tract model.

81. Most of the energy of the tritium beta particles is not deposited in the target cells of the respiratory tract due to their short range. The average depth of the nuclei of these cells range from about 10 to 50  $\mu\text{m}$  in the extrathoracic, bronchial and bronchiolar regions of the respiratory tract [I16]. In the current ICRP model of the human respiratory tract [I16], the tritium beta particles are assumed to deliver a dose only in the alveolar-interstitial region after inhalation of HT. Trivedi and Gentner [T15] noted that the nuclei of target cells within the alveolar-interstitial region, at depths of less than 10  $\mu\text{m}$ , are assumed to receive some dose.

## 3. Contact of skin with tritium-gas-contaminated surfaces

82. Eakins et al. [E1] applied tritium-gas-contaminated metal surfaces to the forearms of four volunteers. The estimated average body content of HTO and OBT were about 0.5 and 0.3%, respectively, of the applied activity of tritium gas. The results did not depend on the type of material tested and the initial body content of organic tritium was less than that of HTO for each volunteer. Urinary excretion of tritium, initially primarily OBT, reached a peak about 24 hours after exposure. Up to 50% of the OBT was excreted via urine with a biological half-time of about one–two days; the rest of the OBT was excreted with a biological half-time of 0.1–0.2 days. One–three weeks after exposure, the tritium was excreted predominantly in the form of HTO with a biological half-time of about 14 days. The effective dose resulting from intake of tritium from contact with a contaminated surface was estimated to be about  $9 \times 10^{-12}$  Sv/Bq [J4].

83. Similarly, Trivedi [T13] used hairless rats and showed that when HT-contaminated stainless steel was brought in contact with intact skin, tritium was fixed as OBT and HTO in the skin and demonstrated biphasic excretion of OBT and HTO.



#### 4. Ingestion of organically bound tritium

84. While HTO diffuses freely in body tissues and enters into equilibrium with body fluids in a matter of minutes or hours [H12, P9], several factors determine the distribution in the body of OBТ ingested through the diet. These include the biochemical composition of OBТ as a mixture of tritiated carbohydrates, fats and proteins, the oxidation rates of the dietary constituents, absorption from the alimentary tract, and the synthesis and retention of organic forms and the HTO and OBТ excretion rates [D5].

85. Experiments indicate that about 3–20 times more tritium is bound to organic compounds in more metabolically active tissue after ingestion of food containing OBТ than that after ingestion of the same activity of tritium in the form of HTO [P7, R11, T3, T6]. This ratio depends on the animals studied (rabbits, rats, mice), the kind of tritium-labelled food (e.g. alfalfa, wheat, meat, shrimp) and the duration of tritium intake (single, few weeks, three generations). Takeda and Kasida [T1] found that, following the intake of HTO by animals, 1–5% of the tritium was incorporated into organic constituents of rat tissue. Therefore, several tens of per cent of the tritium ingested as OBТ would be expected to be incorporated into organic molecules in mammal tissues. The assumption made in the ICRP Publication 60 [I13] that 50% of tritium is incorporated into OBТ in tissues after an intake of OBТ stems from this reasoning.

86. On the basis of all available data, several authors [I12, K15, M1, P6, R11, R12] suggested—as a rounded value—that approximately nine times more OBТ may be present after intake of OBТ than after intake of HTO. This corresponds to a range of 9–45% for the proportion of tritium reaching blood that was retained as OBТ, the remainder being converted to HTO (the wide range resulting from the differing metabolic roles of different OBТ molecules, e.g. as an energy source or a structural component). Further, it was also suggested that the use of a value of 50% would be suitable for general radiological protection applications.

87. While the biokinetic parameters used by ICRP are supported by a range of data, there have been suggestions that the contribution to dose from OBТ may be greater for intake of either HTO or OBТ than predicted by ICRP models. However, the conclusions of Takeda [T4], Komatsu et al. [K21] and Rodgers [R12] are reasonably consistent with the ICRP conclusion that the contribution to dose from OBТ after intake of HTO will be small (<10%) and that the overall dose from intake of OBТ will be greater than from HTO by about a factor of two (the data in table 4 show the ratio in ICRP dose coefficients to be about 2.5).

88. Some experimental data suggest that after chronic intake of HTO, equilibrium tissue concentrations of HTO and OBТ are similar [C25]. Etnier et al. [E3] used a four-compartment model of hydrogen metabolism to show theoretically that OBТ in food can increase the cumulative total body dose by a factor 1.7–4.5 times the free body water dose alone. This model is regarded as providing a reliable representation of tritium biokinetics. The predictions in the model were demonstrated by Takeda et al. [T3] using rats fed with tritiated wheat and HTO. After chronic ingestion of tritiated wheat (22 days), the amount of OBТ in the tissue of rats exposed to tritiated wheat was about 6–11 times higher than when exposed to HTO.

89. Hunt et al. [H19] measured the retention time of tritium in volunteers who had eaten fish that contained OBТ or HTO as a consequence of discharges from the General Electric Healthcare Ltd. plant in the United Kingdom. The excreta from five volunteers were screened for a period of up to 150 days after intake. The results suggested biological half-times ranging from four to eleven days for the retention of the total amount of tritium, with no evidence for a statistically significant contribution from a component with a longer half-time.

90. Animal studies have shown a non-uniform distribution of OBT in soft tissue, and also a non-uniform distribution of tritium in the various organic compounds in the body [D5, I13]. However, with the exception of the special case of DNA precursors, discussed later, any non-uniformity of distribution within cells appears to be small.

91. Richardson and Dunford [R9] conducted a literature review of the studies of exposure to OBT. They proposed two biokinetic models governed by the overall metabolic reactions of the principal nutrients: carbohydrates, fats, and proteins. The parameters for two models of differing complexity—called the HCNO-S and HCNO-C models—were evaluated on the basis of biochemical reactions. The simpler model has a single compartment representing the principal nutrients. The more complex model includes compartments representing the longer-term retention of carbohydrates as glycogen, fats as adipose tissue, and proteins in bone and soft tissue. The differences in the water and organic contents of tissues and organs and the different biokinetics for the different organic components were considered [R8, R9].

92. Melintescu et al. [M10] and Galeriu and Melintescu [G1] developed other physiologically based multicompartiment models where OBT exchange rates were associated with energy metabolism of major groups of human organs and tissues. Model predictions for HTO intake were successfully tested against available human data, e.g. from Trivedi et al. [T14]. Final model solutions were presented as dose coefficients for both HTO and OBT for all ICRP age groups separately for males and females and sex-average values.

93. Table 4 shows values of committed effective dose per unit intake for adults obtained from Richardson and Dunford [R8], an earlier paper of Richardson et al. [R6], other physiologically based models of Melintescu et al. [M10] and Galeriu and Melintescu [G1] and the corresponding values calculated using the ICRP models for HTO and OBT. The dose coefficients from the various studies are similar to the ICRP values [I17]. Richardson and Dunford [R8] also provided dose coefficients for tritiated nutrients, with the lowest value for tritiated carbohydrates equal to  $3.3 \times 10^{-11}$  Sv/Bq, which is 21% lower than the ICRP value for OBT, and the highest value for tritiated protein being  $8.4 \times 10^{-11}$  Sv/Bq, which is twice the ICRP value for OBT [I17, R8].

Table 4. Adult effective dose coefficients from physiologically-based biokinetic models and ICRP models for ingestion of HTO and organically bound tritium

<i>Biokinetic model</i>	<i>Dose coefficient (<math>10^{-11}</math> Sv/Bq)</i>
Ingestion of HTO	
ICRP [I14]	1.8
Richardson et al. [R6]	1.8 (males); 2.2 (females)
Melintescu et al. [M10]	1.7 (males); 2.4 (females)
Galeriu and Melintescu [G1]	2.0
Ingestion of OBT	
ICRP [I14]	4.2
Richardson et al. [R6]	4.2 (males); 6.1 (females)
Richardson and Dunford [R8] and ICRP [I7]	5.0–7.4
Melintescu et al. [M10]	3.9 (males); 5.7 (females)
Galeriu and Melintescu [G1]	4.9

94. Physiological models of OBT biokinetics proposed by Richardson et al. [R6] and Melintescu et al. [M10] provide sex- and age-differentiated biokinetics and dose coefficients. This analysis was based on estimates of daily intake rates of carbon in females (228 g carbon) and males (303 g carbon) and calculated biological half-times of carbon of 51 days and 40 days for female and male adults, respectively. Table 4 presents the dose coefficients from physiologically-based OBT biokinetic models by sex. The dose coefficient is higher in females by about 20–40% for HTO and up to 50% for OBT. Further, the authors state that the modelling of age dependence of the dose coefficients both for HTO and OBT is in good agreement with ICRP data [I17, M10].

## 5. Intake of tritiated biochemical substrates

95. Tritiated biochemical substrates, such as glucose, amino acids, hormones, and DNA and RNA precursors, are produced and widely used in biomedical research, leading to possible exposure by inhalation, skin contamination and possible inadvertent ingestion. A general metabolic feature is that such biochemical substrates may be directly incorporated into organic molecules in body tissue if absorbed to blood and transported intact to sites of active metabolism within cells. The extent of incorporation of tritium into specific forms of OBT is determined by such factors as the chemical compound containing tritium, its isomeric form, the position of the label in the molecule, and the amount of carrier [B11, B12, F2, L1, T2, T4, T8, T10]. Catabolism of labelled compounds will result in tritium being partially oxidized and entering the body water as HTO or catabolized and excreted as low molecular weight organic substances.

### (a) *Tritiated glucose and amino acids*

96. Studies by Takeda [T2, T4] and Balonov et al. [B8, B11, B12], have shown that the bound fraction of tritium administered intraperitoneally to rats as biochemical substrates varied from 3–5% (tritiated D,L-alanine, glucose) to 50–80% (tritiated L-tyrosine, L-lysine). The bound fraction of tritium from tritiated biochemical substrates was substantially larger than that of HTO. The low retention of tritium as OBT after administration of tritiated glucose is consistent with its rapid catabolism while the high retention of tritiated lysine is consistent with its incorporation into protein as an essential amino acid.

97. Retention of tritium administered as the amino acids, glycine, leucine and methionine, was intermediate between that of glucose and lysine. D-isomers of  $^3\text{H}$ -amino acids were assimilated considerably less than L-isomers. Thus, the level of binding of  $^3\text{H}_2$ -L-leucine-2,3 in different tissues, except kidneys, was 2–2.5 times higher than that of the D-isomer, and 1.5–2 times higher than that of racemic mixture. Similar results were obtained with  $^3\text{H}$ -lysine isomers [B8, B12].

98. Figure VII shows the retention curves for OBT in rat spleen after intraperitoneal injection of HTO and some biochemical substrates [B8, B12]. Tritium was rapidly excreted after administration of  $^3\text{H}$ -glucose with a half-time of 3–4.5 days. Retention functions for the majority of  $^3\text{H}$ -amino acids showed two components: one with a half-time from 0.7 to 2 days and the second with a half-time from 7 to 16 days, presumably reflecting metabolism of two groups of functionally different proteins. Retention times were shown to be tissue specific. In actively proliferating tissues—bone marrow, small intestine, testis—the observed kinetics of OBT is influenced by the processes of cell differentiation and movement of labelled cells out of the organ. Due to high demand for L-lysine in tissues and its reutilization, the kinetics of its excretion from tissues is slowed two–three-fold relative to other amino acids [B8, B12, T2, T4].

Figure VII. Specific activity of bound tritium in rat spleens normalized to intraperitoneally injected activity of tritium (per g of body weight) after injection of HTO, D-glucose-6- $^3\text{H}$ , glycine-2- $^3\text{H}_2$  and L-lysine-6- $^3\text{H}$  [B8, B12]

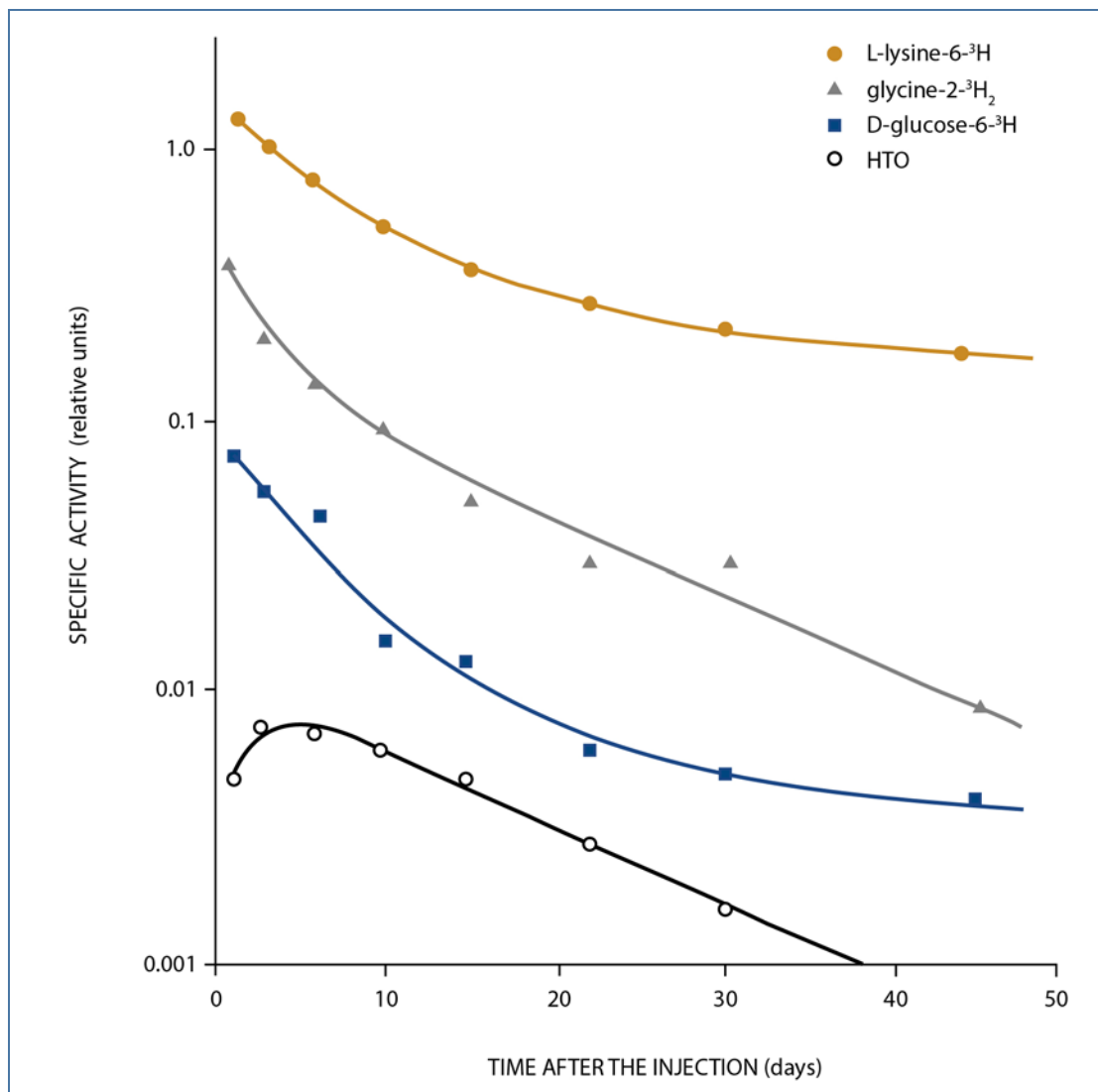

99. Table 5 presents estimated values of absorbed dose (D) in four organs and tissues and the contribution of OBT to dose for HTO and three biochemical substrates derived from the same studies of intraperitoneal administration to rats [B8, B12]. Injection of  $^3\text{H}$ -glucose did not create a dose significantly higher than the dose from an equal amount of HTO, and differed only in the increased contribution to dose from OBT (7–23% against 2.5–4%). The dose following administration of  $^3\text{H}$ -glycine was 5–40% greater than for HTO, and contribution of OBT to the dose reached about 20–40%. Notably, for administration of L-lysine- $^3\text{H}$ , the dose was two–eight times that for HTO, and the contribution from OBT was >90%.

Table 5. Absorbed dose, *D*, in rat organs and tissues (mGy) and OBT contribution to dose (%) after intraperitoneal injection of 37 kBq/g of HTO and tritiated biochemical substrates [B8, B12]

Organ, tissue	HTO		<i>D</i> -glucose-6- <sup>3</sup> H		Glycine-2- <sup>3</sup> H <sub>2</sub>		<i>L</i> -lysine-6- <sup>3</sup> H	
	<i>D</i> (mGy)	OBT (%)	<i>D</i> (mGy)	OBT (%)	<i>D</i> (mGy)	OBT (%)	<i>D</i> (mGy)	OBT (%)
Bone marrow	21	4	21	19	26	38	92	97
Small intestine	–	–	22	23	–	–	59	95
Testis	20	3	19	7	21	24	40	92
Muscle	20	2.5	–	–	28	43	150	98

100. Absorption coefficients for ingestion of and skin contamination by tritiated biochemical substrates were obtained in experiments in which preparations were administered to rats. The absorption coefficient was defined as the average ratio of OBT levels in tissue after ingestion or skin application to those after intraperitoneal injection. While <sup>3</sup>H-glucose and <sup>3</sup>H-amino acids were completely absorbed by the gastrointestinal tract [B12], absorption of <sup>3</sup>H-thymidine was considerably lower (10–20%) because of its degradation to <sup>3</sup>H-thymine in the gastrointestinal tract. In contrast, <sup>3</sup>H-deoxycytidine was absorbed almost completely (60–100%). In rats fed HTO, tritiated amino acids, glucosamine, or tritiated DNA or RNA precursors for 22 days, the greatest concentrations of OBT were found after exposure to amino acids, with intermediate concentrations found after exposure to DNA and RNA precursors [T4]. Studies using rat everted gut sacs showed only about 2% of tritiated thymidine crossed the intestinal epithelium [L2].

101. During six hours after the application of preparations on rat skin, 1–4% of tritiated substrates were absorbed in blood, and 0.01–0.5% of tritium activity was measured in the skin layer at the place of application after its decontamination [B8, B12].

### (b) Tritiated nucleic acid precursors

102. The DNA precursors, deoxythymidine and deoxycytidine labelled with tritium, have most commonly been used in studies of cell kinetics. For work involving RNA, tritiated uridine and adenine are the precursors that have been used [H16]. After tritiated thymidine has been orally administered to humans or animals, about 2% is incorporated into DNA during the synthesis stage of the cell cycle [L2], and the remainder appears as HTO. Tritiated thymidine is available for only a short time after intake and primarily for uptake by rapidly cycling cells such as those of the bone marrow or gut. However, prolonged administration of <sup>3</sup>HTdR throughout gestation results in labelling of slower cycling cells [K11].

103. According to Feinendegen et al. [F5], nuclei of 5–30% of proliferating cells in mammals are labelled by tritium. As the average range of tritium beta radiation is considerably less than the dimensions of the nuclei of mammal cells, and distribution of DNA-bound tritium is extremely inhomogeneous both on the scale of organs and tissues and also within cells, the concept of the average organ or tissue dose in the case of incorporation of <sup>3</sup>H-nucleosides requires care in its interpretation. An alternative is to estimate dose to radiosensitive nuclei in rare cases of tritiated DNA-precursor incorporation by workers.

104. Especially in embryo,  $^3\text{H}$ -deoxynucleosides are actively included in intensively proliferating cell systems of bone marrow and small intestine, and considerably less in tissues with small frequency of mitoses (e.g. muscle, liver). A high concentration of  $^3\text{H}$ -CdR in bone marrow of rats is noteworthy [B12], contrasting with lower values obtained in mice [F5]. The dose in cell nuclei of bone marrow labelled by  $^3\text{H}$ -CdR estimated in studies by Balonov et al. [B8, B12] according to the methodology suggested by Feinendegen and Cronkite [F4, F5] is larger by two orders of magnitude than the average tissue dose from an equal amount of injected HTO.

105. Taylor [T10] reviewed the biokinetics of 11 xenobiotic tritiated organic compounds and estimated that the clearance half-time in humans was less than 40 days in all cases. Some organic compounds may be incorporated directly into structural components and retained for longer periods.

## 6. Metal tritides and other forms with low solubility

106. Tritiated compounds with low solubility include luminous compounds (powder and paint), tritides of metals (e.g. Ti, Zr, Hf), microfragments of glass and carbon and beryllium particles contaminated with tritium. Such compounds are produced and widely used in industry (painting wrist watches and compasses with luminous paint, ionization sources) and research (e.g. accelerator targets, tritium carrier in fusion physics). Tritiated compounds with low solubility are considered as sources of internal exposure in workplaces.

### (a) *Metal tritides*

107. When tritides of metals (e.g. Ti, Zr, Hf) are used for industrial or research purposes, the tritium chemically bound in the crystal matrix is gradually desorbed from the metal surface in the form of HTO or HT. Due to external exposure of the device surface to radiation fluxes and heat, metal tritides can also be released into the work environment in particulate form. The main pathway of radiation exposure of workers dealing with devices containing metal tritides is the inhalation of HTO vapour and airborne particles of metal tritides.

108. Balonov et al. [B8, B11] reported that, following short-term inhalation by rats, titanium tritide (TiT) showed slow lung clearance during one month after exposure. Similar experiments of Cheng et al. confirmed slow clearance of a fraction of TiT (1  $\mu\text{m}$  count median diameter (CMD)) after intratracheal instillation of TiT suspension into rats [C18, Z8]. Similar results were obtained in experiments on rats with hafnium tritide (1  $\mu\text{m}$  CMD) [Z7] and zirconium tritide (0.3  $\mu\text{m}$  CMD) [Z9]. The size of the slow cleared fractions and uptake rates of tritium dissolved from articles depend on the methods of TiT particle production and particle size.

109. In a series of in vitro experiments with powders of titanium, hafnium and zirconium tritides aimed at simulating time-dependent absorption functions of tritium in the respiratory tract of rats and humans, the dissolution of tritium in synthetic serum ultrafiltrate was studied during 30–200 days by Cheng et al. [C17, C19, Z9]. The dynamics of tritium release from particles was well described with two exponentials, one with a half-time in the range from one day (TiT) to about 50 days (HfT and ZrT) and the second with a half-time in the range from one month (TiT) to one year (ZrT) and several hundred years (HfT). The long-term dissolution half-time from coarse powder ( $\sim 100 \mu\text{m}$ ) was larger than from fine powder ( $\sim 1 \mu\text{m}$ ) [C17].

110. In vitro and in vivo experiments were complemented with dosimetric considerations of beta radiation self-absorption in particulate material [C19], which became important for particle sizes of 0.1  $\mu\text{m}$  and more. From the available data, it was concluded that airborne ZrT and HfT should be considered in human internal dosimetry as material of slow solubility (ICRP Type S), and TiT as material of medium solubility (ICRP Type M).

### (b) *Components of nuclear fusion reactors*

111. Tritium is present in nuclear fusion facilities in various physical and chemical forms, some of which have radiological properties different from HTO and HT. In the 1980s, features of tritiated microballoon glass fragments that could be potentially inhaled by workers were studied both in vitro and in vivo [C27, C28]. The median diameter of glass fragments was initially estimated to be about 4  $\mu\text{m}$  but, accounting for fragment shape, the mass median diameter was specified as 20  $\mu\text{m}$ . Experiments in vitro have shown that 98% of tritium is released from glass with a half-time of 3–9 days and 2% with longer half-time of 23–280 days. After intratracheal instillation of tritiated glass fragments in rats, 93% of the tritium activity was removed from glass with half-time of  $6\pm 0.5$  days and 7% with a longer half-time of  $43\pm 3$  days, consistent with the results of the in vitro study. The resultant dose to the lung was three orders of magnitude greater than the dose to other tissues, and approximately 40 times greater than the dose incurred in the lung from the inhalation of a similar quantity of HTO. However, because of the low inhalability of tritiated glass fragments of such sizes, this ratio would be much lower in a direct comparison of inhalation doses.

112. Since 1999, when the Joint European Torus (JET) fusion tokamak started its operation with tritium, tritiated dust and flakes were observed predominantly during maintenance operations. Those carbon, beryllium and tungsten particles were formed due to the interaction of plasma with the carbon-based first internal wall of the fusion reactor. The activity median aerodynamic diameter (AMAD) of the dust particles was assessed to be  $\sim 4$   $\mu\text{m}$  with high specific activities of up to 3 GBq/g and AMAD of flakes as about 100  $\mu\text{m}$  [D4]. After inhalation, the former can deposit in different parts of the respiratory tract and expose its tissue to beta radiation. The in vitro dissolution tests with tritiated dust have shown that 1–5% of tritium activity was dissolved in lung serum simulant within one minute and a further 1–20% of tritium were dissolved over the next 100 days [H15]. Slow excretion of tritium deposited in lungs may complicate its individual monitoring [R13]. From the available data, it can be concluded that carbon and beryllium dust particles from fusion reactors can be classified as material of medium or slow solubility (ICRP Type M or S).

### (c) *Luminous compounds*

113. The basis for self-luminous tritium paint is fine zinc sulphide powder ( $\sim 10$   $\mu\text{m}$ ) coated with a thin layer (0.01–0.1  $\mu\text{m}$ ) of tritiated polymer with high specific activities. In order to reach higher light intensities, tritiated polymers (polystyrene, silicon rubber) with specific activities up to 20 TBq/g have been used [B8, I3]. During the paint luminizing process, workers may be exposed to  $\text{T}_2$ , HTO, and vapours of tritiated organic solvents via inhalation and skin contact. Particles deposited in the lungs will irradiate tissues by emission of beta particles and bremsstrahlung. HTO and unknown organic compounds have been detected in urine [B8, R15], formed by degradation of polymers by radiolysis, oxidation and isotopic exchange.

114. In the past, some workers were exposed to high internal doses that were fatal in a few cases [M15, S12]. Lambert and Vennart have shown that radiological control in the workplace usually necessitates continuous biological monitoring of workers for tritium in urine at relatively short intervals [L5].

115. In vitro experiments have shown that 0.5–5% of tritium from tritiated polystyrene-based “Soviet luminous powder (PS-A)” was gradually released in buffer mixture as HTO and low molecular organic foreign compounds [B8, B11]. In vitro studies of the dissolution of commercial luminous powder made from tritium-labelled polystyrene in bovine serum over five days [R15] showed that an average of 12% dissolved on the first day, and about 2% of the remaining activity on subsequent days.

116. Similar uptake (0.5–5% depending on compound age) of both HTO and low molecular organic compounds was observed in experiments with PS-A luminous powder orally administered to rats and in a similar study with three volunteers [B8, B11]. Substantial fractions of the tritium compounds were rapidly excreted in urine and faeces of rats, a proportion was retained for some days in the liver/kidney, and the remainder was catabolized to HTO. The half-time of organic tritium in human urine was about one day and the remaining tritium was excreted as HTO with a mean half-time of about 16 days.

117. Experiments on cats showed that absorption of tritium from luminous paints depended on the plastic substrate involved, with values of 0.007 for polystyrene, about 0.03 for silicone rubber and 0.8 for polyester [H12, W6]. Balonov et al. [B8, B11] also reported that following intratracheal instillation of PS-A luminous powder into rats, the lung specific activity showed essentially no decrease within five months, demonstrating its very low solubility.

118. In summary, from the available experimental and human data, it can be concluded that the specific characteristics of tritiated luminous compounds differ substantially from those of HTO. Special attention should be paid to individual bioassay monitoring.

## B. Overview of current biokinetic models for tritium

119. Tritium may enter the body by inhalation, absorption through skin, and ingestion. The first two are the more frequent routes of intake in the workplace, while the latter mostly contributes to exposure of members of the public. Furthermore, skin contact with tritium-contaminated surfaces, such as metal and glass, has been shown to result in the formation of OBT in the body [E1]. This has been shown to be a route of tritium intake in the workplace [H12].

120. The fate of tritium once taken into the body is determined mostly by its chemical form. One can expect to find HTO in most workplaces and environmental media where tritium is present. In general, consideration of the biokinetics of OBT refers to the non-exchangeable component resulting from tritium atoms bonding directly to carbon in organic molecules and exhibiting retention times relating to carbon turnover; the exchangeable component of tritium in organic molecules, in the form of hydroxyl and sulphhydryl groups, for example, has the same metabolism and distribution in the body as HTO.

121. Tritiated compounds may also exist as airborne particles, e.g. metal tritides or luminous powder. The retention and clearance of these particles from the respiratory tract depend on several factors, such as particle size and chemical composition. For dose assessment purposes, tritium absorbed into blood after tritiated particles have been inhaled is usually treated as being in the form of HTO [C18, C19, C20, I17].

122. Tritiated compounds are categorized by ICRP for radiation protection purposes according to the metabolic model that best describes their dynamics after intake and subsequent uptake. Three primary metabolic models are currently used by ICRP either separately or in combination to calculate committed effective dose for an intake of tritiated compounds [I8, I9, I10, I12, I14, I17]:



- (a) A model for tritium absorbed to blood as HTO following either ingestion or inhalation, applied also to other tritiated compounds that partially convert to HTO after being taken into the body;
- (b) A model for tritium absorbed to blood following intake of OBT, mainly by ingestion in food, but also applied to inhalation of non-specific organic molecules, and to ingestion or inhalation of some specific tritiated organic compounds;
- (c) The generic ICRP model for the human respiratory tract, specifying absorption parameter values for inhalation of poorly soluble forms of tritium.

123. All three models and respective sets of dose coefficients are widely used by the Committee in its main reports, by the IAEA in its international standards (e.g. [I4]) and also in documents of WHO [W7], FAO and the CODEX Alimentarius Commission [C24]. The ICRP models—and especially dose coefficients—are included in numerous national regulations on worker and public protection against internal exposure with different forms of tritium.

## 1. Dosimetry of tritium using model for HTO

### (a) *Biokinetic model for HTO*

124. The ICRP biokinetic model for systemic HTO [I12, I14, I17], illustrated in figure VIII, is used to calculate the committed effective dose from:

- (a) Intakes of (HTO);
- (b) HTO formed following inhalation of elemental hydrogen (HT, T<sub>2</sub>);
- (c) HTO formed following inhalation of tritiated hydrocarbon vapours and gases (e.g. CH<sub>3</sub>T).

Use of this model involves assumptions about the conversion of the other forms of tritium to HTO.

125. For modelling HTO intake, an instantaneous translocation to blood is assumed for both inhalation and ingestion. The ICRP model further assumes that HTO is transferred from blood with a biological half-time of six hours and distributed uniformly throughout the body. It is also assumed that 97% remains as HTO, while 3% is instantly converted to OBT. In adults, HTO is assumed to be retained with a biological half-time of 10 days, and OBT with the biological half-time of carbon, calculated as 40 days (figure VIII). ICRP values for the partitioning between HTO and OBT after acute intake of HTO in various age groups, and the corresponding biological half-times, are given in table 6 [I12, I14, I17]. Age dependence of biological half-time for HTO was derived by ICRP from available human observations and physiological data [I7].

126. The calculation of committed effective dose per unit intake (dose coefficient) for adults resulting from the intake of HTO, as given by ICRP [I14, I17], is based on the model presented in figure VI. The current value for intake of HTO by adults both by inhalation and ingestion computed by ICRP is  $1.8 \times 10^{-11}$  Sv/Bq [I14, I15, I17].

127. The contribution of the OBT fraction to the committed effective dose in the HTO model has been shown to be about 10% [I8, I9, I10, J3]. This is adequate for estimates of dose from both acute and prolonged intake [T16].

Table 6. ICRP parameter values for distribution and retention of tritium after acute HTO intake [112, 114, 117]

Age	Initial distribution (%)		Biological half-time (days)	
	HTO component	OBT component	HTO component	OBT component
3 months	97	3	3.0	8
1 year	97	3	3.5	15
5 years	97	3	4.6	19
10 years	97	3	5.7	26
15 years	97	3	7.9	32
Adult	97	3	10.0	40

Figure VIII. ICRP model for biokinetics of HTO [112, 114, 117]

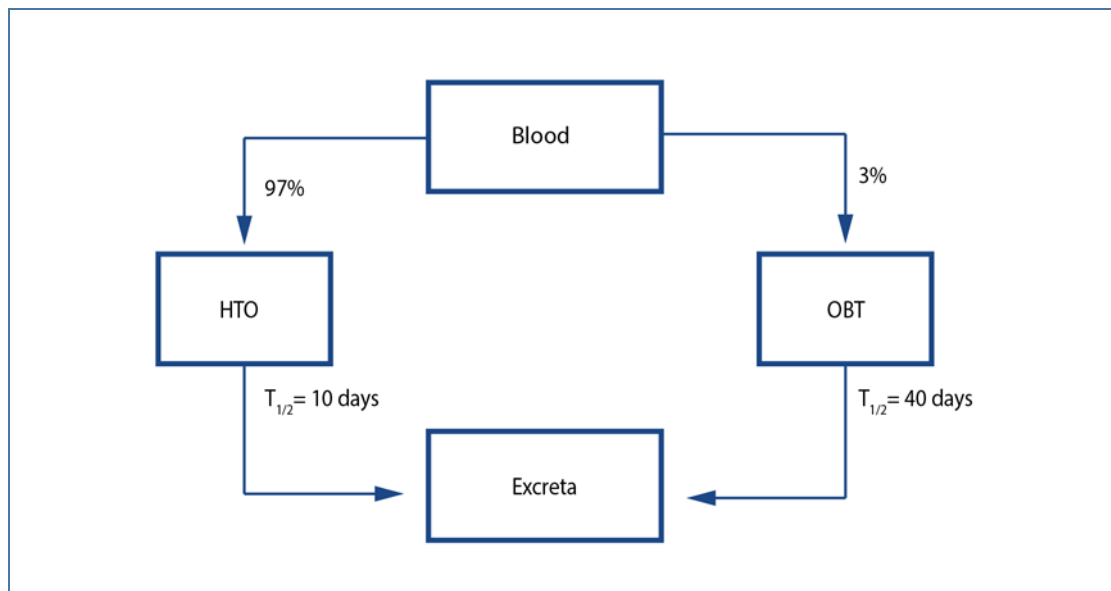

### (b) Absorption of HTO through skin

128. Immersion in a vapour or liquid containing HTO also results in its absorption through the skin [D3, O6, P9]. In the context of occupational exposure to HTO vapour, ICRP [18, 19, 110] referred to the work of Osborne [O6], Hill and Johnson [H12], and the review of Myers and Johnson [M26] and concluded that about 1% of the HTO activity per cubic metre of air may be assumed to be absorbed through the skin in a minute. On this basis, the amount absorbed through skin contributes about one third of the total HTO intake for a given HTO concentration in air when the exposed individual is active during exposure (i.e. breathing in more air than when at rest). The work of Osborne [O6] was based on direct measurements of the absorption rate of HTO vapour through the skin of the whole body.

### (c) Inhalation of tritium gas

129. Following inhalation of HT, a small fraction (about 0.01%) is dissolved in body fluids and oxidized to HTO [P4]. The latter is the predominant contributor to the committed effective dose. HT is not significantly absorbed through the skin and does not readily convert to HTO on the skin. Irradiation of the lungs by inhaled HT does not significantly increase the committed effective dose [I16] because of the short range of the tritium beta particles in lung tissue. The dose coefficient for inhalation of HT is therefore about 0.01% of the dose coefficient used for inhalation of HTO.

### (d) Inhalation of tritiated hydrocarbons

130. Tritiated methane is the only tritiated hydrocarbon for which ICRP recommends a dose coefficient for inhalation based on the HTO model. Tritiated methane is known to be formed as a result of microbial degradation within tritiated waste. About 1% of the inhaled tritiated methane is assumed to be converted to HTO [P5]. The current ICRP dose coefficient for tritiated methane is therefore 1% of that for HTO [I17]. The ICRP approach is considered to give a conservative dose coefficient [P5].

131. Carlisle et al. reported in a more recent study on rats that the fraction of tritiated methane retained in the body as HTO and OBT after acute inhalation to be about 0.06 to 0.13%, which is lower than that assumed by the current ICRP model [C6]. However, the observed conversion of tritiated methane to OBT in rats was greater than that estimated by the ICRP model in all human tissue examined [I17], in particular in the liver, where the conversion was observed to be 22 times greater than that of HTO estimated by ICRP. The authors further suggested that some of tritium taken in as tritiated methane is converted directly to OBT. They concluded that the committed dose to some organs is one third to one tenth of that estimated by ICRP and that the ICRP value of effective dose may be conservative.

### (e) Summary of dose coefficients based on HTO model

132. Table 7 presents the current ICRP committed effective dose coefficients for tritiated compounds based on the biokinetic model for HTO and table 8 illustrates the effect of age on the computed committed effective dose per unit intake for the inhalation of HTO [I17].

Table 7. ICRP effective dose coefficients based on HTO model for various tritiated compounds, modes of intake and age groups [I14, I17]

Tritiated compound	Mode of intake	Dose coefficient (Sv/Bq)	
		Infants (1 year old)	Adults
HTO	Inhalation	$4.8 \times 10^{-11}$	$1.8 \times 10^{-11}$
HTO	Ingestion	$4.8 \times 10^{-11}$	$1.8 \times 10^{-11}$
HT	Inhalation	$4.8 \times 10^{-15}$	$1.8 \times 10^{-15}$
CTH <sub>3</sub>	Inhalation	$4.8 \times 10^{-13}$	$1.8 \times 10^{-13}$

Table 8. ICRP effective dose coefficients for HTO inhalation by various age groups [I17]

Age	Dose coefficient (Sv/Bq)	Ratio of dose coefficient to that of an adult
3 months	$6.4 \times 10^{-11}$	3.6
1 year	$4.8 \times 10^{-11}$	2.7
5 years	$3.1 \times 10^{-11}$	1.7
10 years	$2.3 \times 10^{-11}$	1.3
15 years	$1.8 \times 10^{-11}$	1.0
Adult	$1.8 \times 10^{-11}$	1.0

## 2. Dosimetry of OBT and tritiated biochemical substrates using model for OBT

133. Figure IX illustrates the ICRP model [I14] used to calculate committed effective dose for the ingestion of OBT. It is assumed that OBT, once taken into the body, is translocated to blood completely and instantaneously, and is transferred from blood to tissue with a biological half-time of six hours, with 50% retained in tissue as OBT and 50% transformed into HTO. The uptake and retention of tritium in various tissues depends on the metabolic activity of the individual tissues and the constituent chemical forms of OBT. However, the ICRP model assumes uniform distribution of doses from OBT to all soft tissue in the body while a greater metabolic activity leads to greater uptake and more rapid loss.

Figure IX. ICRP model for biokinetics of OBT [I14]

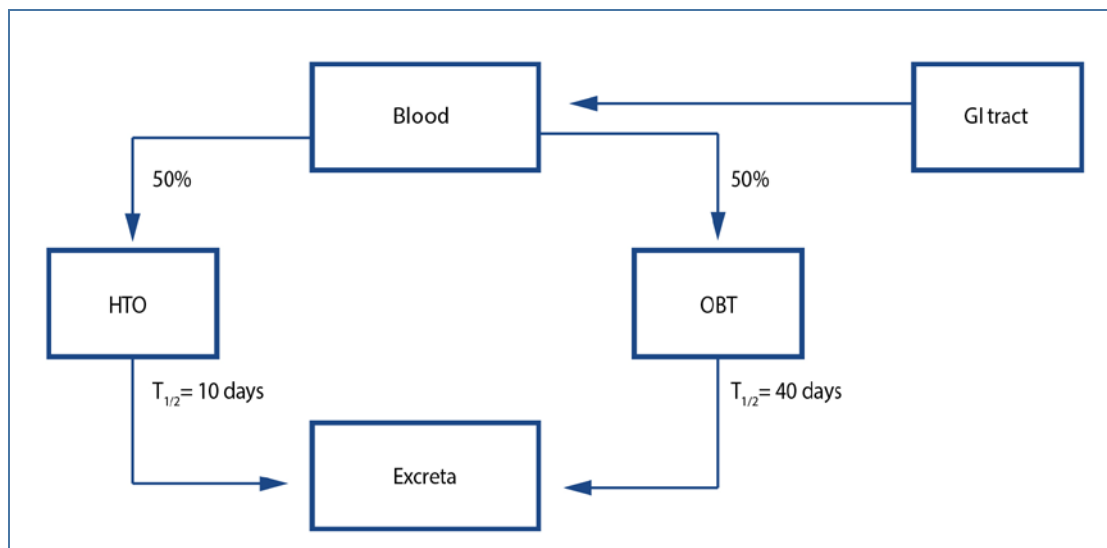

134. The ICRP model for the ingestion of OBT [I12, I14] is intended to represent the biokinetics of the average dietary content of the different chemical forms of OBT. The model was developed in the absence of information about the exact proportions of the various chemical components of OBT in the human diet and the turnover of these components [I12, I14]. On the basis of the turnover of hydrogen in Reference Man, less than 10% of tritium taken in daily as OBT in diet is assumed to be excreted daily in the form of OBT (mostly in the form of urea, with about 3% in faeces) while the rest is assumed to be excreted as HTO [R8].

135. Table 9 gives the assumed partitioning between HTO and OBT and the corresponding biological half-times after dietary intake of OBT in various age groups [I14]. The ICRP committed effective dose coefficients for OBT are shown in table 10 [I17]. Table 11 shows the effect of age on the committed effective dose per unit intake for the ingestion of OBT.

136. The ICRP model for OBT and relevant dose coefficients can also be used for prospective dose assessment in cases of intake of tritiated biochemical substrates if more specific biokinetic information is not available. For most biochemical compounds, this approach will lead to some overestimation of effective dose [T10]. Considering a range of biochemical compounds for which biokinetic data are available from animal experiments, only the essential amino acid, L-lysine-<sup>3</sup>H, resulted in estimated tissue doses greater than those for HTO (by a factor of 2–8) [B11, B12, T2].

137. The ICRP model for OBT and the corresponding dose coefficients are not applicable for dose assessments in cases of occupational intake of tritiated nucleic acid precursors. After tritiated DNA-precursors are taken in by humans or administered to animals, some fraction of tritium is incorporated into DNA during the synthesis stage of the cell cycle [L3], and the remainder appears as HTO or metabolized biochemical substrates. As distribution of DNA-bound tritium and its radiation energy is extremely inhomogeneous in organs, tissues and inside cells, the concept of average organ or tissue dose in this case requires careful consideration. An alternative approach is to calculate dose taking the localization of tritium in cell nuclei into account [F2, F3, F4, F5, N1].

138. The National Council on Radiation Protection and Measurements (NCRP) [N1] examined the absorbed dose resulting from the ingestion of <sup>3</sup>HTdR based mainly on theoretical considerations. For acute intake, it concluded that the absorbed dose to stem cells and bone marrow (per unit intake) resulting from the ingestion of tritiated thymidine is greater by an order of magnitude than that resulting from the ingestion of HTO. This conclusion may need to be revised when additional data on stem cells and <sup>3</sup>HTdR distribution and incorporation rates become available. It was noted that biokinetics of tritiated nucleic acid precursors is strongly dependant on mammal species [B11, B12]. Without appropriate human biokinetic data, the modelling uncertainty remains unspecified.

Table 9. Partitioning between HTO and OBT after dietary intake of OBT [I14]

Age	Initial distribution (%)		Biological half-time (days)	
	HTO component	OBT component	HTO component	OBT component
3 months	50	50	3.0	8
1 year	50	50	3.5	15
5 years	50	50	4.6	19
10 years	50	50	5.7	26
15 years	50	50	7.9	32
Adult	50	50	10.0	40

Table 10. ICRP effective dose coefficients based on OBT model for various modes of intake and age groups [I17]

Tritiated compound	Mode of intake	Dose coefficient (Sv/Bq)	
		Infants (1 year old)	Adults
OBT	Inhalation	$1.1 \times 10^{-10}$	$4.1 \times 10^{-11}$
OBT	Ingestion	$1.2 \times 10^{-10}$	$4.2 \times 10^{-11}$

Table 11. ICRP effective dose coefficients for OBT ingestion for various age groups [I17]

Age	Dose coefficient (Sv/Bq)	Ratio of dose coefficient to that of an adult
3 months	$1.2 \times 10^{-10}$	2.9
1 year	$1.2 \times 10^{-10}$	2.9
5 years	$7.3 \times 10^{-11}$	1.7
10 years	$5.7 \times 10^{-11}$	1.4
15 years	$4.2 \times 10^{-11}$	1.0
Adult	$4.2 \times 10^{-11}$	1.0

### 3. Revised ICRP dosimetry models for HTO and OBT

139. ICRP has developed revised models with improved physiological realism focussing on occupational intakes of radionuclides. Intakes by members of the public will be considered by ICRP at a later stage.

140. The HTO systemic model includes compartments representing blood, extravascular body water that exchanges rapidly with blood, and two components of retention of tritium converted in vivo to OBT. The revised ICRP model structure is shown in figure X. The transfer coefficient from blood to excreta is set to yield an initial removal half-time from the body of 10 days. The transfer coefficients from compartments OBT-1 and OBT-2 back to extravascular HTO correspond to half-times of 40 days and one year, respectively; the net retention half-times in these compartments are slightly longer than 40 days and one year due to recycling of activity. Excretion pathways from blood are not shown in figure X but the following division is assumed on the basis of reference data for water balance ICRP Publication 89 [I19]: urine, 55%; faeces, 4%; exhalation, 12%; and loss through skin (sweat plus insensible loss), 29%.

Figure X. Revised ICRP systemic model for HTO

Reproduced with the permission of ICRP

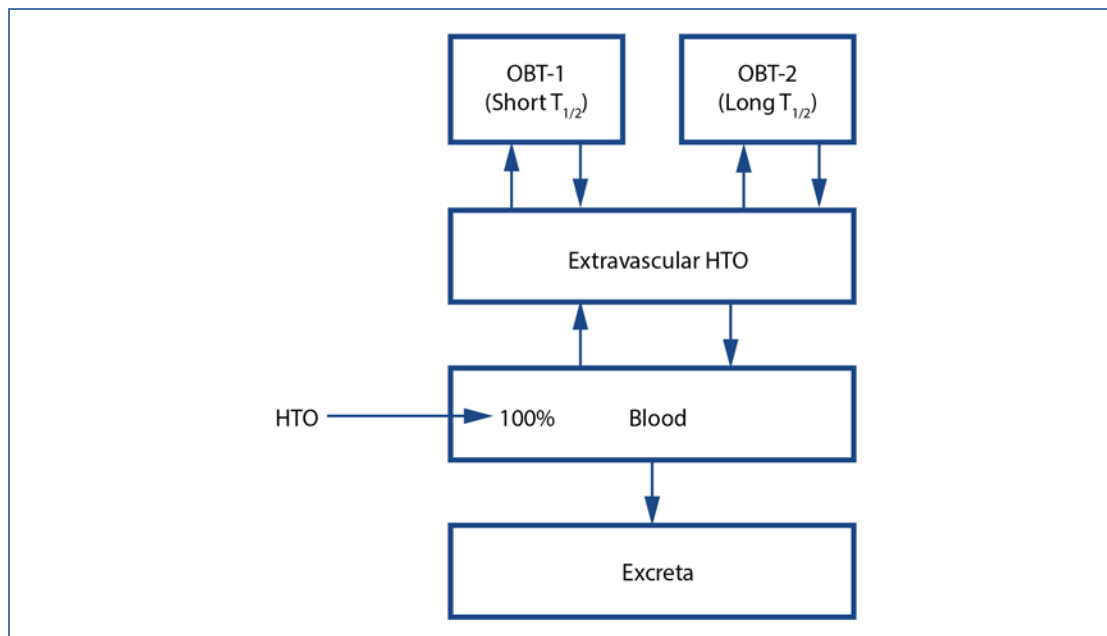

141. The revised model for systemic tritium applied to intake of OBT is a modification of the model for OBT applied in ICRP Publication 56 and is shown in figure XI. In relation to occupational exposures, this model is assumed to apply to “biogenic organic compounds” of tritium for which specific information is not available. It is assumed that 50% of tritium initially entering blood transfers immediately to compartment OBT-1 and 50% is converted immediately to HTO within the blood compartment. Tritium entering OBT-1 or blood subsequently follows the HTO model defined in figure X.

142. The revised model for HTO predicts that OBT would represent about 5–6% of total body tritium following chronic exposure to HTO. The OBT model with the default initial division of activity between OBT-1 (50%) and blood (50%) predicts that OBT would represent about 65–70% of total-body tritium in a worker who is chronically exposed to a biogenic form of tritium. The adult dose coefficient calculated using the revised model for HTO is  $1.9 \times 10^{-11}$  Sv/Bq compared with the current value of  $1.8 \times 10^{-11}$  Sv/Bq. Values for intakes of biogenic organic compounds are given as  $3.5 \times 10^{-11}$  Sv/Bq for inhalation (Type F) and  $5.1 \times 10^{-11}$  Sv/Bq for ingestion (complete intestinal absorption,  $f_A=1$ ). The value for ingestion compares with the current value for OBT of  $4.2 \times 10^{-11}$  Sv/Bq.

143. The ICRP will also publish revised dose coefficients for inhaled tritiated methane and particulate forms for which the HTO systemic model is applied. The revised value for inhalation of tritiated methane by adults is  $5.8 \times 10^{-14}$  Sv/Bq compared with the current value of  $1.8 \times 10^{-13}$  Sv/Bq, reflecting the assumption of 0.3% deposition and absorption to blood as HTO compared with 1% in the current model. Revised values for inhaled particulate forms are  $1.3 \times 10^{-11}$  Sv/Bq for Type F and  $2.4 \times 10^{-11}$  Sv/Bq for Type M, compared with current values of  $6.2 \times 10^{-12}$  Sv/Bq and  $4.5 \times 10^{-11}$  Sv/Bq, respectively. The value for Type S materials is unchanged at  $2.6 \times 10^{-10}$  Sv/Bq.

Figure XI. Revised ICRP systemic model for OBT

Reproduced with the permission of ICRP

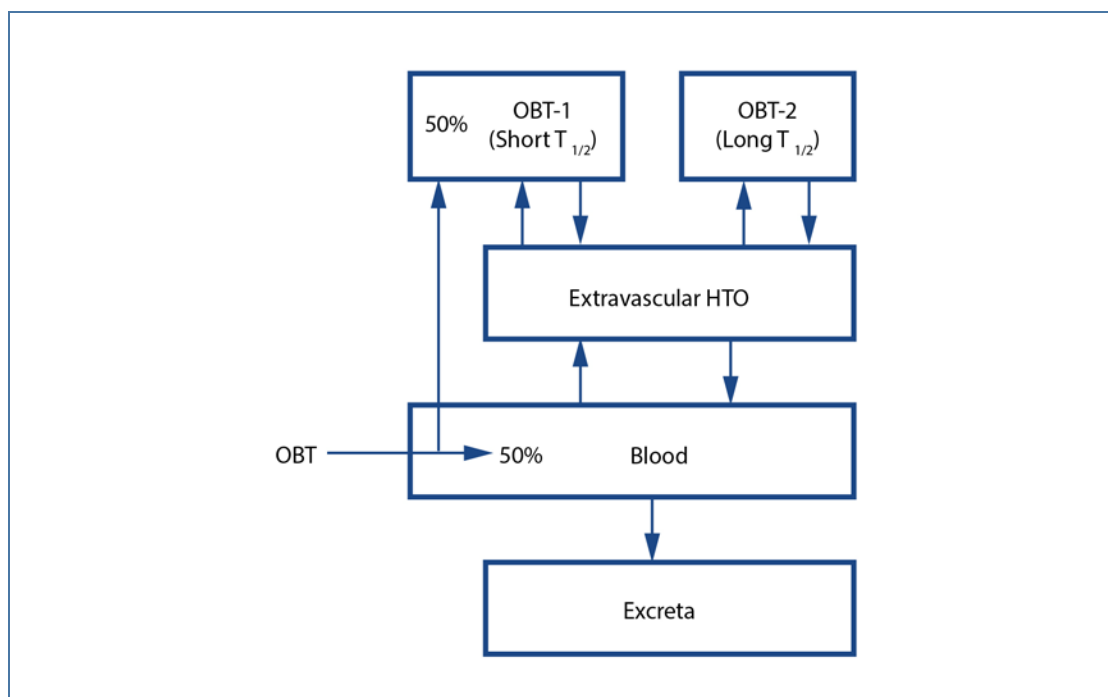

#### 4. Dosimetry of tritiated compounds using model for low solubility particulate tritium

144. Dose coefficients for inhaled particulate tritium were introduced by the ICRP Publication 71 [I17] in 1995 following publication of a number of scientific papers in which those forms of tritium were identified and partially characterized [B8, B11, H12, I3, R15, T8, W6]. The papers described conditions of occupational exposure in research and industry during contact of workers with neutron generators and particle accelerators and with luminous powder.

145. Calculation of dose coefficients for particulate tritium was based on the generic ICRP model of the respiratory tract [I16], categorizing tritium aerosols according to the absorption types specified in the model, i.e. fast (F), medium (M) and slow (S). It was assumed that: (a) beta radiation of tritium located in the alveolar part of the respiratory tract was fully absorbed in lung tissue, and (b) tritium separated from the particles deposited in the respiratory tract, due to both fast and slow processes, behaved as HTO. Therefore, the ICRP generic lung model was combined with the specific ICRP model for HTO (see figure VIII). The clearance of tritium from the respiratory tract following deposition of tritium particles included the escalation of particles through the bronchial tree to the alimentary tract and dissolution and absorption to blood as HTO.

146. Data on the metabolism of inhaled particles of metal tritides are scarce [B8, B11, C17, C18, C19, C20]. In the absence of specific information, ICRP has considered these particles as Type M [I17], meaning that their rate of absorption from the respiratory tract to blood is moderate. Richardson and Hong [R7] conducted dosimetric modelling of inhaled tritiated particles and reported that, while the



dose to the alveole can be up to two orders of magnitude higher than that from the same activity of inhaled HTO, taking account of self-absorption of beta radiation in particulate material can reduce dose by up to an order of magnitude, depending on particle size, in the range of 0.1–10 µm.

147. Following inhalation of tritiated organic compounds such as luminous ones, uptake of HTO is accompanied by uptake of low molecular compounds of tritium originating from degradation of tritiated polymer. The contribution of the tritiated low molecular compounds to the effective dose is generally low because of their rapid excretion in urine and faeces. However, these elevated concentrations of organic compounds of tritium in excreta should be recognized when interpreting the results of individual monitoring.

148. The available dose coefficients for particulate tritium are applicable mostly for occupational radiation protection of workers in research and industry dealing with neutron generators, particle accelerators, and air ionizers and the manufacture of luminous products. However, for the substantially lower probability of exposure of members of the public, ICRP has provided committed effective dose coefficients for different age groups (table 12).

Table 12. ICRP effective dose coefficients (Sv/Bq) for inhalation of particulate tritium of various types [17]

Age	Type F	Type M	Type S
3 months	$2.6 \times 10^{-11}$	$3.4 \times 10^{-10}$	$1.2 \times 10^{-9}$
1 year	$2.0 \times 10^{-11}$	$2.7 \times 10^{-10}$	$1.0 \times 10^{-9}$
5 years	$1.1 \times 10^{-11}$	$1.4 \times 10^{-10}$	$6.3 \times 10^{-10}$
10 years	$8.2 \times 10^{-12}$	$8.2 \times 10^{-11}$	$3.8 \times 10^{-10}$
15 years	$5.9 \times 10^{-12}$	$5.3 \times 10^{-11}$	$2.8 \times 10^{-10}$
Adult	$6.2 \times 10^{-12}$	$4.5 \times 10^{-11}$	$2.6 \times 10^{-10}$

149. Dose coefficients for Type F aerosols are lower than those for HTO despite the assumption of rapid dissolution and absorption of deposited particles. This is because a proportion of inhaled particles is subsequently exhaled while deposition of inhaled HTO vapour is assumed to be complete. The main contribution to effective dose from inhalation of Type M and S aerosols is from lung dose. The dose coefficients presented in table 12 can be applied for internal dose assessment in cases of inhalation of various airborne tritium particles, e.g. metal and graphite tritides and iron hydroxide used in tritium facilities, luminous powder and other particulate forms.

## C. Intakes of tritium in relation to pregnancy and breast-feeding

### 1. Pregnancy and tritium intake

150. A few studies have investigated the transfer of tritiated compounds to the embryo and fetus and their distribution and retention in fetal tissues. In prenatal dosimetry, the term embryo refers to the developing human offspring up to the end of the eighth week of pregnancy, from the initial stages of growth up to the end of organogenesis. At this time, the embryo weighs less than about 10 g.

151. Harrison et al. [H6] measured the transfer, distribution and retention of tritium in rats and guinea pigs following the administration of HTO, tritiated glucose and tritiated food (i.e. liver and cress). Transfer and retention of tritium in fetal tissue were similar for HTO and tritiated food. However, the retention of tritium in both maternal and fetal tissue for tritiated glucose was lower. The ratio of the concentrations of tritium in the fetus ( $C_F$ ) to that in the mother ( $C_M$ ) at the end of organogenesis in rats ranged from 0.4 to 1.0. At the end of pregnancy, the ratio ranged from 1.3 to 1.5 in the case of rats and from 1.1 to 1.3 in the case of guinea pigs.

152. Takeda et al. [T5] exposed female rats to single oral administrations of HTO, tritiated thymidine or tritiated lysine. No significant differences were observed between the tritium concentrations in the fetus and in maternal tissue. Tritium concentrations in the fetus were greater following the ingestion of tritiated lysine than following the ingestion of HTO or tritiated thymidine. Tritiated lysine also resulted in greater prenatal and neonatal absorbed doses than tritiated thymidine and HTO by factors of 1.5 (when tritium was administered on the thirteenth day of gestation) and 6 (when tritium was administered on the first day of nursing).

153. Pietrzak-Flis et al. [P7] studied tritium incorporation in rats chronically exposed to tritiated food (activity concentration, 48.1 kBq/g) or HTO (activity concentration, 37.0 kBq/mL) for three successive generations (from three weeks before mating of the parents to the delivery of the F3 generation). The analysis of tissue at various ages showed that the absorbed dose rates were higher in rats exposed to HTO. However, the amount of tritium incorporated into the organic fraction of tissue was several times higher after exposure to tritiated food.

154. Kowalska [K22, K23] reported further results from the same study showing that the amount of tritium incorporated into the amino acids of rat-brain proteins and the main rat-brain phospholipids and gangliosides was higher after the ingestion of tritiated food than after the ingestion of HTO. The highest tritium concentrations in rat-brain proteins followed in utero exposure while the highest tritium concentrations in phospholipids and gangliosides were found in 21-day-old rats exposed during pregnancy and lactation.

155. The ICRP Publication 88 [I18] has provided biokinetic and dosimetric models and dose coefficients for the embryo, fetus and newborn as a result of intake of radionuclides by the mother. The term fetus refers to the developing human offspring after the eighth week of pregnancy [I18]. The equivalent dose to the embryo is assumed to be the same as that to the uterus wall and proportional to the concentration of HTO in maternal body water. For the calculation of the equivalent dose to the fetus, the HTO concentration in fetal body water was assumed to be equal to that in the mother. The ICRP uses a simple approach to the calculation of fetal doses for the majority of elements and their radioisotopes, including tritium, considering data collected from studies of animals and humans [I18, I21]. These fetal doses from tritium are calculated on the basis of relative concentrations of tritium averaged over the whole body of the fetus ( $C_F$ ) and that of the mother ( $C_M$ ). The  $C_F:C_M$  ratios are taken mainly from studies presenting data obtained at short times post-intake.

156. HTO rapidly crosses the placenta after it is inhaled or ingested by the mother. The resulting equivalent dose to the fetus depends on the water content of the fetus over the course of its development. As gestation progresses, the water content decreases relative to the amounts of protein, fat and minerals—from about 95% of the total body mass at the sixth week of pregnancy to about 70% at birth. For comparison, the percentage of total body water in a non-pregnant woman is about 50%. The total water content of the mother's body is known to increase during pregnancy. This is mainly due to the increase of about 50% in the blood volume in order to carry additional nutrients and other substances needed for the fetus. Calculations have shown that the biological half-time of HTO in the

mother varies from about 10 days at the start of pregnancy to about 12 days at term. This variation does not significantly affect the ICRP fetal dose coefficients for HTO [I18].

157. On the basis of an average body water content of 80% for the fetus and 50% for the mother, ICRP used a  $C_F:C_M$  ratio of 1.6 in the derivation of the dose coefficients for HTO. This ratio is applied to both the HTO and OBT components for intake of OBT and is assumed to remain constant throughout pregnancy. Tritium is assumed to be uniformly distributed throughout all tissues of the fetus. Harrison et al. [H7] showed that the  $C_F:C_M$  ratio ranged from about 1.4 to 1.8, on the basis of data for the relative water content of the mother to that of the fetus.

158. Following birth, the ICRP biokinetic model for the three-month-old infant [I18] is used to calculate the committed effective dose per unit intake by the newborn child. Table 13 presents the committed effective dose coefficients for the unborn and the three-month-old child. The ICRP [I18] has published a range of dose coefficients for in utero exposure of the child following maternal intake by inhalation or ingestion, before or during pregnancy, considering acute and chronic exposure. Account is taken of the retention of activity in body tissue at birth and dose delivered post-natally. The purpose of the ICRP fetal dose coefficients is to allow comparison with doses to other age groups in order to ensure that protection does not neglect doses received in utero [C29, I22].

Table 13. ICRP prenatal and infant effective dose coefficients [I18]

Tritiated compound and mode of intake	Prenatal dose coefficient (Sv/Bq)		Dose coefficients for 3-month-old child (Sv/Bq)
	Acute maternal intake <sup>a</sup>	Prolonged maternal intake <sup>b</sup>	
HTO inhalation	$3.6 \times 10^{-11}$	$3.1 \times 10^{-11}$	$6.4 \times 10^{-11}$
HTO ingestion	$3.6 \times 10^{-11}$	$3.1 \times 10^{-11}$	$6.4 \times 10^{-11}$
OBT ingestion	$7.6 \times 10^{-11}$	$6.3 \times 10^{-11}$	$1.2 \times 10^{-10}$

<sup>a</sup> Values are for acute intake by the mother at the end of the tenth week of pregnancy. Acute intake occurring at other times yields lower dose coefficients.

<sup>b</sup> Prolonged intake by the mother, beginning at the start of pregnancy and continuing for the duration of the pregnancy.

## 2. Intake of tritium from maternal milk

159. The ICRP [I21] has developed dose coefficients for newborns for intake of tritium from maternal milk. The approach involved the estimation of the activity transferred to milk as a function of maternal intake for various intake scenarios (acute or prolonged intake regimes, and for various maternal intake times relative to birth). Nursing was assumed to continue for six months after birth, and the ingestion dose coefficients for infants were applied [I14]. Maternal intake (by ingestion and by inhalation) during pregnancy and during lactation was considered.

160. The HTO and OBT models were modified by ICRP [I21] to account for the transfer of tritium to milk fed to infants (up to one year). The rate of OBT transferred to milk was taken to be that of carbon. The ICRP developed dose coefficients on the basis of the assumption of six feeds per day and an average daily milk intake by the infant of 0.8 L. Table 14 shows selected committed effective dose coefficients for nursing infants resulting from maternal intake of tritium.

Table 14. ICRP effective dose coefficients for nursing infant [I21]

Tritiated compound and mode of intake	Dose coefficient (Sv/Bq)	
	Acute maternal intake <sup>a</sup>	Prolonged maternal intake <sup>b</sup>
HTO inhalation	$2.2 \times 10^{-11}$	$2.0 \times 10^{-11}$
HTO ingestion	$2.2 \times 10^{-11}$	$2.0 \times 10^{-11}$
OBT ingestion	$3.5 \times 10^{-11}$	$3.0 \times 10^{-11}$

<sup>a</sup> Values are based on acute maternal intake at one week after birth. Acute intake occurring at other times yields lower dose coefficients.

<sup>b</sup> Values are based on prolonged intake during the lactation period (up to six months after birth). These dose coefficients are greater than those for prolonged intake during pregnancy.

## D. Uncertainties in dose coefficients for tritium

161. Dose coefficients applied for assessment of internal dose for purposes of human radiation protection are defined by ICRP as regulatory parameters without any uncertainty [I23]. They are presented in ICRP publications for reference persons [I7, I19] as values depending on the radionuclide, its physical and chemical form, exposure pathway (inhalation or ingestion) and a person's age [I12, I14, I15, I17, I18, I21]. Uncertainties of ICRP dose coefficients for some radionuclides, including tritium as HTO, are systematically considered in a specific NCRP publication [N4] and by Leggett et al. [L8]. The need for individual values of metabolic parameters arises mostly in cases of emergency intake of large radionuclide activities when probabilities of radiation-induced acute health effects and risk of stochastic effects require consideration on an individual basis in the context of possible decorporation or other medical treatment.

162. For the most common form of tritium, HTO, dose coefficients for adults are determined on the basis of numerous human observations and are, therefore, associated with low uncertainty. Greater uncertainties apply to dose coefficients for children exposed to HTO from the environment. Leggett et al. [L8] considered the sources, quality and completeness of data underlying the biokinetic models for tritium (as HTO) and concluded that the dose coefficient for HTO is known within a factor of two for an adult and between a factor two and three for a five-year-old child.

163. Exchange model parameters for HT inhalation are also derived from human observations, which can generate moderate uncertainty of corresponding dose coefficients. More uncertain are dose coefficients for OBT based on animal experiments and modelling and for tritium aerosols of various types based on both in vitro and in vivo animal experiments [P4, P9].

164. Harrison et al. [H7] reviewed the assumptions used by ICRP in the derivation of dose coefficients for tritium along with their associated uncertainties. The assumptions considered were those related to absorption to blood, the biological half-time of HTO and OBT in adults and children, the transfer to the fetus, the heterogeneity of the distribution in tissues and cells, and the RBE value of the beta particles emitted by tritium.

165. Harrison et al. [H7] estimated uncertainties using ranges on the central values for the incorporation of tritium into OBT in body tissue of 0.01–0.1 and 0.15–0.75 of the tritium activity reaching blood after intake as HTO and OBT, respectively. Biological half-times in adults were taken to vary from about 5 to 20 days for HTO and from about 20 to 200 days for OBT, these ranges being

the 2.5 and 97.5 percentiles of the log-normal distributions. They also considered  $C_F:C_M$  ratios ranging from 1.4 to 1.8 based on the relative content of water in the mother and the fetus. The 2.5 and 97.5 percentiles of the log-normal distribution for the OBT transfer and distribution in fetal tissue were taken to be 1.2 and 2. A range of 1–2.5 was used for the RBE value of tritium beta particles compared to gamma rays. This analysis gave median (50%) values for the dose coefficient of  $2.3 \times 10^{-11}$  Sv/Bq for HTO and  $5.6 \times 10^{-11}$  Sv/Bq for OBT for ingestion or inhalation by adults, excluding consideration of RBE value. Table 15 shows probability distributions of the committed effective dose coefficients for adults and for the fetus after ingestion by the mother during pregnancy, including the range of RBE values. Dose coefficients for other age groups were estimated to vary by a factor of two to three for HTO and OBT.

Table 15. Probability distributions of effective dose coefficients from ingestion of HTO or OBT by adults and for fetus after ingestion by mother during pregnancy [H7]

Intakes during pregnancy assumed to take place at 10 weeks after conception

Age	Form	Distributions of effective dose coefficients ( $10^{-11}$ Sv/Bq)		
		5 percentile	50 percentile	95 percentile
Adult	HTO	2.1	3.9	6.6
	OBT	3.9	8.7	20
Fetus	HTO	3.7	7.6	14
	OBT	6.9	17	40

166. Hamby [H2], using Monte Carlo sampling, calculated that the dose coefficient for intake of HTO by adults varied by a factor of 15 from its highest to lowest modelled values, with a median value of  $2.2 \times 10^{-11}$  Sv/Bq and a geometric standard deviation of 1.6. This range was most sensitive to the biological half-time, the linear energy transfer (LET), and the reference radiation (i.e. whether X- or gamma radiation). When the quality factor was set to unity, the geometric mean of the dose coefficient was  $1.3 \times 10^{-11}$  Sv/Bq with a geometric standard deviation of 1.4.

167. Melintescu et al. [M10] also assessed the effect of uncertainty on the RBE value of the tritium beta radiation, the retention of HTO and OBT and the presence of tritium in the DNA hydration shell. For the adult male, setting the radiation weighting factor to unity (based on the RBE value) resulted in dose coefficients ranging from 1 to  $2.9 \times 10^{-11}$  Sv/Bq for the intake of HTO and from 5 to  $6.7 \times 10^{-11}$  Sv/Bq for the ingestion of OBT. Accounting for the variability in the radiation weighting factor, the resulting dose coefficient range was from 1.5 to  $5.1 \times 10^{-11}$  Sv/Bq and 5 to  $11.3 \times 10^{-11}$  Sv/Bq for HTO and OBT, respectively. Similarly, the dose coefficient for a one-year-old was found to vary from 2.9 to  $6.6 \times 10^{-11}$  Sv/Bq and 14 to  $18 \times 10^{-11}$  Sv/Bq for HTO and OBT, respectively, when the radiation weighting factor was set to unity.

## E. Summary of biokinetic and dosimetric models

168. HTO behaviour following intake into the mammalian body is well understood with regard to both early distribution in the body followed by excretion as part of water exchange (half-time of adult humans 4–18 days) and simultaneous conversion of a small fraction (of the order of 1%) of tritium into OBT with subsequent longer term excretion (half-time of adult humans 23–104 days). The average contribution of OBT to effective dose of adults derived from 17 human observations was 3.0%. The

data on longer term processes with half-times of more than 100 days are highly uncertain and need further study. The ICRP biokinetic model for HTO for all age groups is moderately conservative, with an OBT contribution to dose equal to 9% for adults. The biokinetics of HT following inhalation is also well understood. However, the current ICRP model considers only HTO formed in vivo and does not take account of an additional component of dose to cells of the alveolar-interstitial region of the respiratory tract.

169. The ingestion of food containing OBT by members of the public results in the degradation of a substantial fraction of the OBT to HTO in the gastrointestinal tract and in body tissue by catabolic reactions, and uptake and conversion of the rest of the OBT into tissue macromolecules. Both the fractions and subsequent excretion rates of OBT from tissue depend on food origin and composition. The ICRP model for OBT ingestion by humans is generally consistent with experimental results. However, it does not consider the non-uniform deposition of OBT between various organs and tissues. Physiologically-based OBT models, such as the ones proposed by Richardson and Dunford [R8] and Galeriu and Melintescu [G1], consider non-uniform deposition. Dose coefficients calculated using these models are generally similar to ICRP values.

170. Tritiated biochemical substrates, such as glucose, amino acids, hormones, DNA and RNA precursors, may be directly incorporated into organic molecules in body tissues if absorbed to blood and transported to sites of active metabolism within cells. The extent of incorporation of tritium into specific forms of OBT is determined by such factors as the chemical compound containing tritium, its isomeric form, position of the label in the molecule, and the amount of carrier. OBT formed from tritiated precursors of biological macromolecules is retained in tissue longer than HTO. Catabolism of labelled compounds will result in tritium being partially oxidized and entering the body water as HTO or catabolized and excreted as low molecular weight organic substances. Following intake of tritiated precursors of biological macromolecules, the internal dose to mammal tissue is usually up to ten times larger than the dose from intake of an equal amount of HTO, and the contribution of OBT to dose may dominate.

171. Labelled DNA precursors (e.g.  $^3\text{H}$ -thymidine,  $^3\text{H}$ -deoxycytidine) entering the mammalian body by various routes are partially degraded to HTO and partially incorporated into the DNA of dividing cells, and thereafter selectively expose nuclei of proliferating cells to beta radiation.  $^3\text{H}$ -deoxynucleosides are preferentially incorporated into the proliferating cell systems of embryo and fetus, bone marrow and small intestine at any age and, to a substantially lesser extent, in tissue with lower frequencies of mitoses (e.g. muscle, liver). For both acute and prolonged intake of tritiated DNA precursors, the absorbed dose to nuclei of proliferating cells may be larger by one to two orders of magnitude than the dose from intake of equal amounts of HTO. As the average range of tritium beta radiation is considerably less than the dimensions of the nuclei of mammal cells, the use of average organ or tissue dose in the case of incorporation of  $^3\text{H}$ -nucleosides requires careful consideration. The ICRP dose coefficients for OBT should not be directly applied to intake of tritiated DNA precursors.

172. Tritium particles of low solubility (e.g. metal tritides, luminous powder) inhaled by workers in occupational conditions partially deposit in the respiratory tract and may be retained in the lungs for long periods. Material-specific labile fractions of tritium segregate from particles as HTO or as organic molecules that are absorbed to blood and excreted. Effective doses from inhalation of low soluble tritium particles can be assessed by means of the ICRP human respiratory tract model combined with the HTO model. Tritium as HTO or biochemical substrates is easily transported through the placenta to the embryo and fetus and secreted in maternal milk. In conditions of chronic tritium intake by the mother, committed internal doses incurred by the embryo and fetus and by the suckling infant correlate with the dose of the mother and are not substantially different in magnitude.

## VI. BIOLOGICAL AND HEALTH EFFECTS

### A. Non-radiological effects of tritium in biological systems

#### 1. Transmutation

173. Transmutation is the conversion of one element into another through radioactive decay. When tritium undergoes decay, it becomes helium-3 ( $^3\text{He}$ ), a stable, inert gas. Helium is chemically very different from hydrogen and, therefore, this could make a significant contribution to the effect of tritium when organically combined. If a tritium atom is bound to a DNA molecule when it decays, most of the kinetic energy will accompany the beta radiation as it is ejected from the nucleus, but some energy will provide a kick-back to the  $^3\text{He}$  atom as recoil energy. Kacena [K1] determined that the recoil energy was too small (up to 3 eV) to cause ionization of the DNA molecule on its own. However, the resultant  $^3\text{He}$  atom would break free from the DNA molecule. In complex molecules, the effect of this conversion to a positively charged carbonium ion would be difficult to distinguish because of the proximity to the deposition of energy and associated events from the beta emission.

174. Myers and Johnson [M26] and Gracheva and Korolev [G8] performed comprehensive reviews of transmutation effects. They noted that the degree of damage caused by transmutation of tritium into helium could theoretically vary significantly, depending on the position of the tritium atom in specific DNA nucleotides. The studies covered several test systems in the S13 virus, in two strains of the bacterium *E. coli*, in *Drosophila Melanogaster* (fruit fly) and in cultured mammalian cells. On the basis of the position of the tritium in the nucleic acid, varying degrees of damage were observed in experiments. The most pronounced mutagenic effect was detected with cytosine-5- $^3\text{H}$ , which in the case of tritium decay converted to uracil. In some simple biological systems (virus, *E. coli*), that transmutation resulted in an elevated mutation rate that was 3–400 times larger than the mutation rate caused by beta radiation only [G8]. The reviewers argued, however, that the increase in the mutation rate in mammals (resulting from transmutation) would not likely exceed 5% of the normal rate and that this was too small to be detected.

175. Carsten [C11] discussed the possibility that such effects would be manifest in humans after ingesting HTO or OBT as food. He suggested that the risk was small enough to pose no significant hazard, primarily because only 2% of the hydrogen atoms in DNA were located at the 5-position of the cytosine ring and damage would be minimal. Feinendegen and Bond [F3] reached the same conclusion—that “the effects of intracellular tritium are overwhelmingly due to beta irradiation of the nucleus” and “transmutation effects do not produce a measurably increased effect under most conditions.” The United Kingdom Advisory Group on Ionising Radiation (AGIR) [H16] came to a similar conclusion. If DNA damage in mammals did occur from transmutation, it is unlikely that it could be distinguished from radiation-induced damage and thus would be already accounted for in measured RBE values.

#### 2. Isotopic effects

176. While chemically similarly to hydrogen, tritium has slightly different physical properties due to its increased mass. Diabaté and Strack [D5] noted that synthetic reaction rates decreased as atomic mass

increased, causing a significant isotopic effect of OBT depletion with tritium compared with HTO from which biological macromolecules are synthesized. In contrast, once fixed to carbon, C-T bonds are cleft more slowly than C-H bonds. In equilibrium conditions of OBT synthesis in plants grown in a medium with HTO, the isotopic ratio of tritium specific activity in hydrogen of OBT in bulk organic matter to that in water was in the range of 0.6–0.8 [D5].

177. Intracellular discrimination between tritium and hydrogen atoms due to isotopic differences (in particular a mass ratio of 3) have been considered in the past (see e.g. [C11, M2]) and concluded to be of little consequence for the risk of tritium. However, contrary to the traditional view of OBT in biomatter, experiments that used denaturing agents have suggested that a proportion of tritium may be designated as “buried tritium”, a tightly bound HTO [B13]. In such a fraction, the buried tritium in biomacromolecules, such as proteins, is in positions where the exchange rates are substantially reduced as a consequence of the three-dimensional structure that arises upon the “folding” of these biomacromolecules. The hydrogen bridges between the molecules of water are stronger than between organic configurations, resulting in accumulation of tritons both inside the biopolymers and within their primary hydration shields. There is an enrichment of tritium in the newly identified buried hydrogen bonds compared to the free water in the cell. In most biomolecules, the enrichment may be 1.4-fold but in DNA, where the hydration shell consists of 11 molecules per nucleotide and is not readily permeable to ions, the enrichment in the water trapped in the core may be twofold. While this will certainly result in slightly more beta tracks originating from HTO within and around the DNA, it remains true that the vast majority of beta tracks encountered by the DNA will have originated from HTO outside the DNA since that is where most of the HTO is situated. The effect on radiation dose to the DNA will therefore be small but may increase the RBE value in experimental determinations.

## B. Deterministic effects

### 1. Lethality

178. Brues et al. [B26] investigated the lethality of tritium by giving mice single injections of 0.126–8.4 GBq of HTO. The dose that killed 50% of the population within 30 days ( $LD_{50/30}$ ) was about 9 Gy, which corresponds to an initial activity concentration of tritium of 37 MBq/g of body weight (BW). Furchner [F13] reported an  $LD_{50/30}$  of 8 Gy, for HTO given in a single intraperitoneal injection of 33 MBq/g to  $CF_1$  female mice. Yamamoto et al. [Y2] (see also [Y6]) reported an  $LD_{50/30}$  of about 8 Gy after a single injection of 0.56 GBq in C57BL/6N female mice and about 13 Gy with an injection of 0.93 GBq in female (C57BL/6N × C3H/He) F1 mice. Overall, these data suggest a  $LD_{50/30}$  dose of the order of 10 Gy.

179. Yamamoto et al. [Y2] also investigated the lethality of a continuous oral administration of HTO as drinking water in (C57BL/6N and C3H/He) F1 female mice. The tritium concentration reached a plateau in organs and blood after about seven days. Haematopoietic death typically occurred after two weeks following ingestion of HTO with activity concentrations from 0.15 to 0.6 TBq/L in drinking water. The lowest absorbed dose to cause death was estimated to be about 11 Gy from the continuous ingestion of 0.15 TBq/L of HTO.

180. The dose from tritium necessary to cause death in mice appears to be similar to that from acute external irradiation by X-rays or gamma rays, with tritium  $LD_{50/30}$  values of about 6–9 Gy, corresponding to an acute intake of the order of 1 GBq of HTO. In the literature, there are some published historical cases of radiation sickness of workers caused by tritium [M15, O3, S12], including two lethal cases.



181. In 1963, a worker in a radiological laboratory in the former Soviet Union had an intake of about 350 GBq of HTO [O3] due to violation of safety rules. Monitoring of tritium in urine started 25 days later, when the worker had visited a doctor because of deteriorating health. Tritium concentration in urine declined with a half-time of seven days and the committed equivalent dose in soft tissues was assessed to be about 12 Sv. Treatment started immediately after visiting the doctor. Pronounced radiation sickness symptoms were observed during 1.5–2 months after the accident. After about 1.5 months, regeneration of the haemopoietic system began but substantial recovery of leukocyte and neutrophil concentration in blood took more than three months. The patient returned to work after six months. Medical surveillance over 2.5 years showed recovery of working capacity and the absence of substantial adverse effects in internal organs.

182. In the late 1950s and early 1960s, several workers at two European facilities for production of tritiated luminous compounds used large quantities of tritium (4–10 TBq per annum) [M15, S12]. In the course of chemical operations, each worker incorporated substantial amounts of tritium. Measurements of tritium in urine started in the 1960s and were used for dose assessment. In case A-1, tritium concentrations in urine varied in the range of 2–40 MBq/L. From these data, the equivalent dose in soft tissue was assessed as 3–5 Sv over the four years preceding death [S12]. An assistant to A-1 (A-2) received a dose that was about half of that received by A-1 and stopped working with tritium after she showed moderate anaemia. Workers A-3 and A-4, who succeeded A-1 and A-2, worked under improved conditions and incurred lower doses without health effects. In case B-2, the dose incurred over three years before death was assessed from tritium measurements in urine in the range from a few sieverts up to 20 Sv. In both cases A-1 and B-2 there was substantial contribution to dose from OBT, as indicated by measurements made on autopsy samples, and both workers died with clinical signs of an aplastic pan-myelocytopenia complicated by pulmonary or other symptoms [S12].

## 2. Effects of HTO on animal embryo and fetus

183. Straume and Carsten [S23] reviewed the current literature on exposure to tritium during fetal development. During particular periods of development, some fetal cells will be dividing rapidly and differentiating to form tissues and organs, while other cell types may be showing very little or no cell proliferation. Tritium that is incorporated into OBT of low proliferation cells could result in larger integrated doses to these cells, since the tritium would not be diluted by further cell proliferation. However, uptake will be dominated by those cells undergoing rapid division. Commerford et al. [C26] reported that the dose from tritium incorporated from HTO into macromolecules, such as DNA and histones, of rapidly dividing cells was small compared with that from the same activity of tritium in the form of HTO.

184. In a study by Laskey et al. [L7], rats were continuously fed HTO with activity concentrations of 0.37–370 kBq/mL from conception of the first generation until delivery of the second. The corresponding dose rates were 0.03–30 mGy/d. Exposure to HTO with an activity concentration of 370 kBq/mL resulted in a 30% weight reduction of the testes in the first generation of adult males, but there was no impairment of overall growth or reproductive ability. In the second generation of newborns, decreases in the weight of the brain, overall body weight and litter size were found. An increase in resorption for rats exposed to HTO with an activity concentration at 370 kBq/mL was also found. However, Laskey et al. [L7] did not observe any effects on litter size or resorption at or below an activity concentration of 37 kBq/mL (which corresponds to a dose rate of about 3 mGy/d).

185. Bursian et al. [B27] assessed the effects of continuous exposure of rats to HTO from conception to birth. The activity concentrations used were 0, 37, 370 and 3,700 kBq/mL. In utero exposure to doses

as low as 0.66 Gy (corresponding to the highest concentration used) produced measurable and persistent decreases in brain weight and increases in norepinephrine concentrations at 21 and 45 days after birth. No differences from the controls were observed in the rate of turnover or the concentrations of dopamine, acetylcholinesterase or monoamine oxidase.

186. Jones et al. [J8] gave pregnant squirrel monkeys water with tritium levels ranging upwards from 2 kBq/mL throughout gestation. No effects on body weight, body dimensions, organ weights, haematological patterns, or the histology of organs or tissues, with the exception of ovaries, were observed in newborn progeny. However, the number of primary oocytes in female progeny decreased markedly with increasing levels of HTO in maternal drinking water.

187. Yamada et al. [Y1] studied the effect of prolonged in vitro exposure to HTO and  $^{60}\text{Co}$  gamma radiation on pre-implantation mouse development after mating female C57BL/C3H F1 and male ICR mice. With the development to blastocyst as the end point, the  $\text{LD}_{50}$  was 4.4, 8.5 and 15.8 MBq/mL corresponding to beta radiation dose rate of about 10, 20 and 40 mGy/h, respectively, for pronuclear, early two-cell, and late two-cell embryos, respectively. Compared to  $^{60}\text{Co}$  gamma radiation, the RBE value of tritium beta radiation was in the range of 1.0–1.7.

188. The effects of tritium on the morphogenesis and development of rats and mice have been studied by several authors. Wang and Zhou [W3] reported modifications in the cognitive function of young rats born to mothers that had been injected with HTO on the thirteenth day of pregnancy that resulted in 0.1 and 0.3 Gy of in utero exposure. Gao et al. [G2] showed decreases in cognitive behaviour and a significant decrease in hippocampal pyramidal cells in the brain's CA1 area with intraperitoneal injections of HTO on the thirteenth day of gestation that resulted in 0.09 and 0.27 Gy of in utero exposure. Sun et al. [S25] reported a decrease in the brain weight of mice exposed on the thirteenth day of gestation to a dose of 0.4 Gy (from the injection of HTO of 964 kBq/g of body weight); both the thickness of the somatosensory cortex and pyramidal cell density were significantly decreased at this dose. Jain and Bhatia [J2] also observed pathological changes in the cerebellum of mice following exposure of the mothers to HTO. An initial injection of HTO was given at 17 days post-conception followed by additional intake of HTO of 111 and 11.1 kBq/mL. The observed damage was dose dependent.

189. Zamenhof and van Marthens [Z3] studied how five generations of rats were affected by pre- and post-natal exposure to HTO. Female rats were given water containing HTO with an activity concentration of 111 kBq/mL beginning in adolescence and continuing throughout pregnancy. This exposure to tritium did not produce any signs of radiation-induced disease in the mothers. The courses and outcomes of pregnancy were also normal, but 60% of the newborn rats exhibited haematomas, oedemas and subdural haemorrhages. None of these effects lasted beyond 30 days. Zamenhof and van Marthens [Z4] subsequently found that there were decreases in the weight and DNA and protein content of the brain in later generations of rats continuously drinking water containing HTO with an activity concentration of 111 kBq/mL (estimated average daily intake for a 60 g rat—the weight of a 30-day-old—was 2.1 MBq, corresponding to an absorbed dose rate of about 1.4 to 8 mGy/d). The effects were generally most evident in all generations (F2–F5) except the F1 generation. In addition, all but the F1 generation showed some recovery over time.

190. In summary, radiation-induced effects on the embryo or fetus (principally neurological or reproductive tissue impairment) have been demonstrated in laboratory animals exposed to tritium. Such effects start occurring at chronic intake of activity concentrations of HTO of about 50–100 kBq/mL of body water and are consistent with similar effects from external photon irradiation. Embryo–fetal effects in animal studies are observed at doses of about 0.4–0.6 Gy from chronic intake of HTO.

### 3. Immunological effects of HTO

191. The Committee has conducted a number of reviews of the effects of exposure to ionizing radiation on the immune system, the most recent being given in its UNSCEAR 2006 Report, annex D [U12]. The major conclusions from that review were the following:

- “High doses of radiation produce immunosuppression mainly through destruction of cells. Lymphocytes are very radiosensitive, and their destruction is currently used as an early indicator of the level of an accidental acute exposure. Radiation-induced changes in immune parameters seem to be more dependent on total dose than on dose rate. Persisting effects on immune system have been observed after exposure to ionizing radiation.
- At low doses and dose rates, the effects of ionizing radiation on the immune system may be suppressive or stimulatory. The long-term effect of low radiation doses on the immune function in relation to human health needs to be further evaluated.”

192. However, very few studies specifically reference exposure to tritium. Some reports have come from studies of workers exposed occupationally and also from experiments carried out in the *in vitro* or *in vivo* systems.

193. Tuschl et al. [T17] investigated some immunological parameters in ten NPP workers exposed during a four-week period to external radiation (total effective doses ranged from 1.4 to 9.8 mSv) and tritium inhalation (committed effective doses ranged from 1.2 to 2.8 mSv). Twenty-five days after the beginning of the exposure, only the CD4<sup>+</sup>/CD8<sup>+</sup> T cell ratios were markedly elevated compared to the ratios detected in non-exposed controls and the effect was mainly due to an increase in the absolute numbers of CD4<sup>+</sup> T helper cells. In five exposed subjects who agreed to give blood samples five months after the first sampling, the CD4<sup>+</sup>/CD8<sup>+</sup> T cell ratios were still elevated.

194. Milacić [M14] analysed blood samples from 53 workers exposed to tritium. The workers were separated into three groups depending on the duration of occupational exposure: 0–5, 6–15 and 16–30 years. The groups were compared with each other and with a control group. Effective doses were not provided, but the average tritium activity concentration in urine of the exposed subjects was 1.9 kBq/L. Although total leukocyte counts did not differ from the control group, lymphocyte and eosinophil counts were higher in the workers exposed to tritium and varied with the duration of the exposure, being the lowest in the 6–15 years group. Chromosomal aberrations were detected in 49% of workers exposed for 10.5 years and with a significantly higher average tritium concentration in urine (3.5 kBq/L). However, the average tritium activity concentration in the exposed subjects with no aberrations was 0.35 kBq/L. Alkaline phosphatase and myeloperoxidase activities in granulocytes were significantly lower in all exposed workers. The author interpreted the increase in lymphocyte counts as a stimulation of the immune system by tritium and in eosinophil counts as a compensatory reaction of the bone marrow in response to impaired function of granulocytes. The workers had no clinical manifestations of immunity disorders.

195. In 1980, Kirillova and Luzanov [K16] compared prolonged exposure of CBA mice to HTO and external gamma radiation (from <sup>137</sup>Cs) delivered in equal daily radiation doses (cumulative dose 4.1 Gy). They observed a decrease in the immune response. The antibody and rosette-forming capacity of spleen cells was lower in the group exposed to HTO than in the group exposed to gamma radiation. On the basis of the total immune response observed over the entire treatment period, they concluded that HTO was 1.27 times more efficient in decreasing the immune response than gamma radiation. They suggested that the observed diminution of the immune response was due mainly to damage to the lymphoid tissue and also to disruption of haematopoiesis. Later on, Kirillova [K19] conducted a similar

experiment, but used rats instead of mice. After a prolonged intake of HTO, the decrease in normal killer cells (NK)<sup>2</sup> activity in rats was less and the recovery was more rapid than observed in mice for the same total dose (about 8 Gy). The authors linked this observation to the higher metabolic rate in mice compared to rats.

196. In another study of changes in the concentration of NK cells as an end point, Kirillova [K17] treated mice to HTO at an activity concentration of 0.37 MBq/g of body mass over six months and compared them with a non-treated group of mice. The exposure to HTO resulted in a decrease in the activity of NK cells by 35–45% in the treated mice when compared with the reference group ( $p < 0.05$ ) at three months after administration of HTO had ceased. Six months later, the NK cell function had recovered and was even higher by a factor of 1.8 in the mice that had been treated with HTO than in the control group.

197. Kirillova et al. [K18] also studied the quantitative and qualitative degree of recovery of the immunological system in mice after prolonged exposure (throughout life; around 725 days for the controls and 650 days for the treated mice) to HTO with an activity concentration of 0.37 MBq/g of body weight giving a total dose of 8.7 Gy. The authors observed a depopulation of cells in bone marrow, spleen and thymus, which persisted until the end of the lives of the animals. They suggested that the disruption in immunological response was caused early in the treatment by a reduction in the numbers of lymphocytes and by a lower activity of B cells and tritium helpers and, later after radiation exposure, by the impairment of tritium helpers function. There was a direct relationship between the immunodeficiency and the dose rate and the total absorbed dose of beta radiation.

198. Smirnov et al. [S14] concluded that prolonged exposure of CBA mice to daily intake of HTO of 0.19, 0.37 and 0.74 MBq/g of body weight up to doses ranging from 0.2 to 1 Gy, resulted in an impairment of humoral immunity at various stages of the immunopoesis at all dose levels. They also showed a direct relationship between the depopulation of colony forming units (CFU) (early precursors of T and B lymphocytes) and dose rate. They concluded that the production of antibody forming cells was a function of the absorbed dose and that a prolonged exposure to HTO resulted in impaired humoral immunity at various stages of immunopoesis. They also demonstrated that the mechanisms generating the immunological response were highly sensitive to the tritium beta radiation.

199. As demonstrated more recently by Umata et al. [U4], a single intraperitoneal injection of HTO to C57BL/6N mice to give a total whole-body dose of 3 Gy significantly increased the number of variants of the T-cell receptor expressed on splenocytes. The frequency of apoptotic cells of the spleen 12 hours after HTO injection increased to 5.0%.

200. In summary, experimental studies carried out in animals indicate that prolonged exposure of animals to HTO associated with relatively high radiation doses (in the range of 1–8.7 Gy) resulted in some diminution in the immune response in animals which, depending on the dose, could be reversed. In contrast, the few studies carried out in workers occupationally exposed to low doses of tritium demonstrate that such exposure can stimulate immune functions, but also increase the frequency of chromosome aberrations in lymphocytes. However, it is not clear whether such effects, even at high doses, had any significant health consequences. More research on the effects of acute and protracted low-level exposure to tritium on the immune system is warranted.

---

<sup>2</sup> A cytotoxic lymphocyte.

## 4. Germ cell effects of HTO

### (a) *Effects in females*

201. Because tritium distributes itself throughout the body, it can be taken up by developing oocytes and incorporated into DNA. Tritium incorporated into human oocyte DNA could theoretically irradiate the oocytes over 30 or more years. Because oocytes do not divide until fertilized, there is little turnover of the DNA molecules, which implies that the biological half-time of the tritium embedded in oocyte DNA could approach the radioactive half-life of tritium of 12.3 years. Forell et al. [F8] pointed out that if a biological process were to gradually exchange all the components of DNA molecules—including that of tritium-labelled DNA—it would take 50 years to replace 2–5% of a cell's genome (DNA). The author estimated that in resting lymphocytes 2,000 bases per hour were turned over. Therefore, most of the tritium incorporated into an oocyte will remain there for its whole life. This issue was also discussed by the United Kingdom Health Protection Agency [H16] in relation to the discharges from a radiopharmaceutical plant. They concluded that tritium could be incorporated during pregnancy into the DNA of fetal oocytes and remain there until fertilization decades later.

202. Straume and Carsten [S23], in reviewing the effects of radiation exposure on oocytes, reported that most of the information on radiosensitivity in humans came from autopsies of women who had been exposed to substantial doses of external radiation [L13], and from fertility histories of women who had undergone radiotherapy or had been exposed as a consequence of the atomic bombings in Japan [B5, L14, U5]. In all cases, the data were for short-term external exposure of adult women.

203. In female mice, data suggest that premature oocytes are more radiosensitive than mature oocytes [B3]. This is in contrast to results in human females that demonstrate that from 3 days after birth, all oocytes are equally radiosensitive. In women, exposure of 2.5–6 Gy to X- or gamma radiation will lead to permanent sterility [I11, I20]. There is no temporary sterility in human females as there is in mice.

204. Dobson and Kwan [D6, D7] continuously exposed non-inbred Swiss-Webster mice to HTO and <sup>60</sup>Co gamma rays during the early period of oocyte development from conception until 14 days after birth. Oocyte survival following tritium exposure decreased exponentially with dose rate with no threshold; the LD<sub>50</sub> level was 0.074 MBq/mL of body water corresponding to 4.4 mGy/day. Exposure to <sup>60</sup>Co gamma rays was shown to be less effective at the same dose and did not follow an exponential relationship. As a result, the RBE value of tritium beta radiation, compared with gamma radiation, increased with decreasing dose and dose rate from about 1.6 at gamma-ray dose of 0.4 Gy to about 3 at lower doses. In studies of both mice and rats, Satow et al. [S4, S5] studied the effectiveness of exposure to tritium in killing immature oocytes. Statistically significant oocyte resorption was found at activity concentrations of HTO of 0.34 MBq/g of body weight and more, corresponding to a total dose of 77 mGy and more.

205. A number of animal studies have investigated the continuous administration of HTO or tritiated thymidine throughout pregnancy and analysis of the subsequent effect on oocytes in the offspring. This method of continuous administration in rats was pioneered by Fliedner et al. [F7] and Schreml et al. [S7] and subsequently adapted by Lambert and Phipps [L6] using mice. Using this method, Haas et al. [H1] studied the effect of HTO infusion in utero on post-natal oocyte development in rats. During the first 21 days of life post-conception, a dose dependent reduction in oocyte numbers was observed. At birth, 54 MBq infused had reduced the numbers by 50% whereas 215 MBq produced total aplasia of oocytes. They suggested that tritiated thymidine was about ten times more effective than HTO for this effect. In a subsequent paper [S8], these authors concluded that this factor was about 3.7 in relation to radiation dose to the oocyte cell nucleus.

206. Lambert and Phipps [L6] exposed pregnant SAS/4 mice to HTO in drinking water and, by constant infusion, to tritiated thymidine throughout pregnancy. A number of parameters were studied in the offspring including oocyte survival at 14 days of life. They concluded that for this parameter tritiated thymidine was about two–three times as effective as HTO in causing oocyte lethality.

207. Pietrzak-Flis and Wasilewska-Gomulka [P8] also studied the effect of constant intake of HTO or tritiated food on oocyte survival in Wistar rats from birth and sampled at ages 21 and 71 days. They found that tritiated food was more effective at reducing oocyte numbers.

208. In summary, the female reproductive system shows great discrepancies between mice and humans. For humans, the reproductive system is radiosensitive to a dose of 2.5–6 Gy given in a single fraction. Exposure to doses within that range will cause permanent ovarian failure due to the killing of oocytes, and will be accompanied by features associated with menopause. It is anticipated that such a dose of tritium in the ovaries would have a comparable effect.

### (b) *Effects in males*

209. Unlike oocytes, spermatogonia are continuously produced from stem cells throughout adult life. Like all tissues that are rapidly replaced, there are certain germ-cell stages that are highly sensitive to cell killing by ionizing radiation. Experiments in mice conducted by Oakberg in 1955 and 1959 showed that the most sensitive cells are the type A and B spermatogonia, which can be reduced by 50% with doses of only about 0.3 Gy of acute X-rays (reported in [S23]). The spermatid and spermatozoa stages are much less sensitive than the spermatogonia stage (Oakberg and Clark, 1964 as reported in [S23]). Lambert [L3] found a 27% reduction in spermatogonia of mice injected with tritiated thymidine at an activity concentration of 0.19 MBq/g of body mass and with HTO at an activity concentration of 2.2 MBq/g of body mass (dose to the cell nucleus of 84 mGy and 49 mGy, respectively).

210. Carr and Nolan [C9] studied the reduction of testis mass in mice following single injections of tritiated thymidine (0.037–0.74 MBq/g of body mass) or HTO (0.37–1.48 MBq/g of body mass) and <sup>60</sup>Co gamma rays (delivered to match the dose-rate vs. time curve in the 1.48 MBq/g HTO group). The radiobiological effect was investigated at times from one hour to 24 weeks after injection. Measurements of the testicular retention of tritium were also made at these times. There was a progressive loss in mass, up to 30% after 4–5 weeks, followed by an irregular recovery, which was more delayed in the case of the animals injected with tritiated thymidine. Time-integrated fractional testis mass loss was a linear function of injected HTO activity. The RBE value of HTO compared with <sup>60</sup>Co gamma rays was 1.43 at gamma-radiation dose of 0.6 Gy. As only one gamma-radiation dose level was used, RBE dependence on dose could not be assessed.

211. Balonov et al. studied reduction of testis mass in mice following single intraperitoneal injection of HTO (0.4–12.6 MBq/g of body mass) or exposure to <sup>137</sup>Cs gamma radiation delivered during ten days with exponential reduction of dose rate with a half-time of 2.5 days similar to HTO excretion rate [B10]. The range of tritium beta-radiation dose was 0.12–3.4 Gy and that of gamma-radiation dose was 0.25–3.7 Gy. Statistically significant relative testis mass reduction was observed in the dose range from 0.25 Gy of both tritium beta radiation and gamma radiation. RBE values in terms of relative testis mass reduction increased from 1.9 at mass reduction of 40% (dose of tritium beta radiation 0.8 Gy) to 2.2 at mass reduction of 10% and corresponding lower dose of about 0.2 Gy. In summary, it has been shown by studies using both external radiation and tritium administration that certain stages of spermatogonia development are particularly sensitive to radiation. Most studies concluded that a ratio of effects (mostly lethal) compared to gamma radiation was in the range of 1.4–2.2.

## C. Stochastic effects of HTO in mammals

### 1. Carcinogenicity

212. Many laboratory studies on animals have demonstrated that exposure to tritium, both as HTO and tritiated compounds, can induce cancer although the carcinogenic effect of exposure to tritium has not been studied as extensively as that of gamma radiation and X-rays.

213. Cahill et al. conducted two studies involving the administration of HTO to pregnant Sprague-Dawley rats to term in a range resulting in whole-body doses during gestation of 0.066–6.6 Gy [C1, C2]. In their first study, increased incidence of mammary fibroadenomas was detected in dams exposed at 3.3 Gy and 6.6 Gy, but not at lower doses. In the second study, offspring surviving beyond 30 days were observed throughout their life and neoplasia recorded. Intrauterine exposure to doses of up to 0.66 Gy had no significant effects on overall cancer incidence rate or onset of mammary fibroadenomas. In addition, females exposed in utero to 3.3 or 6.6 Gy had lower incidence rates of mammary fibroadenomas and at 6.6 Gy females had a lower incidence of overall neoplasia compared to the control unexposed rats. These females, however, were sterile and had reduced mean life spans.

214. Seyama et al. [S13] reported on a series of studies involving acute intraperitoneal injections of relatively high levels of HTO to 7–8-week-old female (C57BL/6N × C3H/He) F1 mice at the activities resulting in internal whole-body doses from 2.0 to 10.5 Gy. The animals were observed for up to 750 days and cumulative neoplasia was compared to the effects of chronic irradiation by either gamma rays or fission neutrons. The effect (incidence of cancer) seems to have nearly saturated at the lowest dose level; that is, the total incidence of tumours was similar at 500 days and later in all exposed groups (about 80%) in contrast to the control group (less than 5%). The authors also studied induction of thymic lymphoma in mice that received 7.9 or 10.5 Gy from a single intraperitoneal injection with those that received equal doses in four subsequent injections with weekly intervals. In the latter case, the latent period was much shorter and lifetime lymphoma incidence was significantly higher than after a single injection.

215. Yamamoto et al. [Y3] reported a study involving continuous oral administration of five levels of HTO to female (C57BL/6N × C3H/He) F1 mice from 10 weeks of age resulting in a dose rate to soft tissues of 0.01–0.24 Gy/day. Lifetime tumour incidence approached the maximum level (83%) already at the lowest dose rate (0.01 Gy/day) while spontaneous incidence was 54%. Exposure to larger dose rates accelerated development of most studied tumours, which resulted in substantial life shortening. The main cause of death of mice exposed to higher dose rates (0.096–0.24 Gy/day) was thymic lymphoma. At lower dose rates, non-thymic lymphomas and solid tumours were also observed. Both shortening of the latent period and life shortening due to development of tumours significantly increased with dose rate of tritium beta radiation and the increases were significantly larger than those after irradiation of mice with X-rays or gamma radiation from a <sup>60</sup>Co source. In a later similar study [Y4], the same authors exposed mice to three lower levels of HTO in drinking water from ten weeks of age resulting in a dose rate to soft tissues of 0.0002–0.0036 Gy/day. The life span was discernibly shortened in the group with a larger dose rate (0.0036 Gy/day) due to shortening of latent periods for tumour development. In the groups of mice with lower dose rates, both this effect and incidence of thymic lymphoma were missing.

216. A study by Johnson et al. [J5] estimated the lifetime incidence of myeloid leukaemia in seven groups of about 750 CBA/H mice each; radiation exposure was approximately 0, 1, 2 and 3 Gy both for HTO and for X-rays. The lifetime incidence of leukaemia in these mice increased from 0.13% in the

control group to 6–8% in groups exposed to higher radiation doses. The results were fitted to various equations relating leukaemia incidence to radiation dose, using both the raw data and data corrected for cumulative mouse-days at risk. The calculated RBE values for tritium beta rays compared to X-rays ranged from  $1.0 \pm 0.5$  to  $1.3 \pm 0.3$ . A best estimate of the RBE value for this experiment was about  $1.2 \pm 0.3$ .

217. Gragtmans et al. [G9] estimated RBE for tritium radiation in reference to 200 kVp X-rays, using acceleration of breast tumour appearance in the female Sprague-Dawley rat as the end point. Chronic X-ray doses of 0.3–2.0 Gy were delivered over ten days. Intraperitoneal injections of HTO ranging in concentration from 45 to 370 MBq/100 g of body weight were administered, followed by four additional injections at two-day intervals and half of the initial concentration. RBE estimations were based on various criteria including the tumour incidence per Gy at 450 days post-irradiation and the time required to induce tumours in 50% of the animals at risk. The results suggest that tritium beta rays are about 1.1–1.3 times more effective than chronic 200 kVp X-rays for acceleration of the appearance of rat mammary tumours. However, the uncertainties involved in these calculations are such that the effects of tritium beta rays could not be reliably distinguished from those of chronic 200 kVp X-rays.

218. Revina et al. [R1] described a study in rats which were administered HTO intragastrically five times a week for six months. The effects (leukaemia and other cancer) on these animals were compared with those on a group chronically exposed to gamma radiation delivered in daily doses comparable to the tritium dose rate. The main problems with this study are the high doses and the fact that there was only one dose point in the tritium and gamma exposed groups. An estimate of RBE of about 2.5 was made in this study.

219. Intraperitoneal injection of HTO to male N5 mice several times over 30 days (so that the exposure period comprised all stages of spermatogenesis) to give a total dose of 1.5 Gy resulted in a statistically significant increase of leukaemia incidence among their young (less than 210-day-old, but not yet one-year-old) offspring [D1]. It appeared that the overall leukaemia incidence in the offspring of the HTO-exposed fathers was significantly dependent on the maturation stage of the sperm-forming cells during the HTO exposure. However, in a paper by Balonov et al. [B12] which summarizes Russian studies on tritium carcinogenicity. Mice and rats were given HTO in drinking water at a dose range of 0.24–25.3 Gy. Although most malignancies were increased, the absence of a positive dose–response and occasionally a negative response makes interpretation of these data difficult.

220. Yin et al. [Y5] used 12-day-old male and female pups of C3H/HeN mice that were given a single intraperitoneal injection of HTO at the activities of 0.23, 0.92 and 3.70 MBq/mouse and then observed for 14 months for the development of tumours. In the males, a significantly increased incidence of liver neoplasms was detected whereas in the females, only an insignificantly elevated incidence of ovarian cancer was observed in mice exposed to the highest concentration of HTO.

221. Studies in which administration of tritiated material was compared with the effects of similarly protracted X- or gamma-radiation exposure are the most reliable sources of RBE data. This is important in the absence of such data for human exposure. Four of the more comprehensive studies [G9, J5, R1, S13] were critically examined in the AGIR report [H16] and the conclusion was that, due to deficiencies in the experimental design and statistical analysis, the findings from these studies should be treated with caution. However, taken together, they indicate an RBE value with a central estimate in the range 0.8–2.5 with an upper 97.5 percentile value of no more than about 3.

222. Straume [S22] undertook a literature review of the risks, including cancer induction, from exposure to tritium. Because information was not available for humans, cancer-risk estimates for tritium were derived from experimental animal (mostly mouse) studies. Straume calculated a skewed risk distribution (with a fiftieth percentile risk per unit dose of  $81 \times 10^{-6} \text{ mGy}^{-1}$  with a 90% confidence



range of  $38\text{--}185 \times 10^{-6} \text{ mGy}^{-1}$ ) using Monte Carlo methods and distributions of dose-rate effectiveness and multiplying by best estimate RBEs for tritium (based a central value of the RBE of 2–3 ranging up to 4.5). This was comparable to radiation risk estimates in the Committee's UNSCEAR 1988 Report [U6], in the ICRP Publication 60 [I13] and in the BEIR V Report of the Committee on the Biological Effects of Ionizing Radiation [N6].

## 2. Heritable effects

223. In its UNSCEAR 2001 Report [U10], the Committee noted that no radiation-induced hereditary diseases had (to that date) been demonstrated in humans. Nonetheless, since such effects are seen in plants and animals, the Committee provides an approach for estimating such risks [U10].

224. Russell et al. [R17] studied the incidence of seven specific locus mutations in ( $101 \times \text{C3H}$ ) F1 wild-type male mice using about 40,000 offspring of males exposed to HTO with weighted mean doses of 4.3 Gy to post-spermatogonial germ cells and 6.2 Gy to spermatogonia. The observed mutation spectrum was similar to those following previous exposure to external X- or gamma radiation. The radiosensitivity of post-meiotic cells was similar to that observed for acute exposure to X-rays. For spermatogonia, comparison was made with earlier experiments with low-dose rate gamma radiation showing that the mutation rate was twice as high in the case of tritium exposure.

225. Pomerantseva et al. [P10] studied reciprocal translocations (RTs) in mouse stem spermatogonia induced by HTO and  $^{137}\text{Cs}$  gamma radiation. HTO was administered to males by a single intraperitoneal injection and excreted with a half-time of about 2.5 days. In order to adjust exposure conditions, the dose rate of gamma radiation was reduced exponentially with the same half-time. Mean doses of testis cells were 0.5, 1.0, 1.9 and 3.4 Gy of tritium beta radiation and 1.0, 1.9 and 3.7 Gy of gamma radiation [B9]. In the post-sterile period, three–five months after exposure commenced, ten–twelve males from each experimental group and four–five males from control groups were sacrificed. From each male, 100–200 spermatocytes were analysed at the stage of diakinesis-metaphase of the first meiotic division, and the number of multivalents in the form of rings and chains recorded. The groups of animals exposed to beta and gamma radiation at a dose of 2 Gy were also studied over two–eight months and reciprocal translocation frequency did not significantly change during this period. This observation indicates that elimination of cells with translocation from populations of spermatogonia exposed continuously at low dose rates is insignificant. The increase of reciprocal translocation frequency with increasing dose was observed over the entire dose range up to 3–4 Gy. The RBE of tritium in this study was estimated to be 1.8; dose dependence of RBE was not observed.

226. The ICRP Publication 103 [I23] has stated that “there continues to be no direct evidence that exposure of parents to radiation leads to excess heritable disease in offspring”. Nevertheless, on the basis of the results of animal experiments and, citing the Committee's UNSCEAR 2001 Report [U10], ICRP estimated, for protection purposes, a nominal genetic risk of about  $0.2\% \text{ Gy}^{-1}$  for up to the second generation (grandchildren). For low-LET radiation, the ICRP value for the probability of severe heritable effects is 0.5% per Gy for the reproductive population, estimated on the basis of mouse data.

227. Straume and Carsten [S23] noted that the heritable effects observed for other low-LET radiation were also present following exposure to HTO. By grouping the RBE studies with genetic end points (such as chromosome aberrations and mutations in mice), they determined that the RBE values ranged from 1 to 3, with the higher values associated with low doses and low-dose rates, largely owing to the curvilinear response for the reference radiation.

### 3. Germ cell effects

228. This subsection presents effects of tritium exposure of mammalian germ cells in one or several generations that result in progeny death. These effects are interpreted as stochastic, presumably caused by damage to genetic material of a single cell, but not transferred to the next generations because of the lethal nature of the radiation-induced mutation.

229. Carsten and Commerford studied dominant lethal mutations (DLMs) in Hale-Stoner-Brookhaven strain mice resulting from chronic HTO ingestion [C10]. In a two-generation study, mice were maintained on drinking water with 0.11 MBq/mL HTO. Radiation doses to germ cells of the second generation animals tested for DLMs were 0.28 Gy in females and 0.38 Gy in males. Mice were mated at the age of eight weeks, pairing exposed males and females and exposed and non-exposed. Statistically significant increases in DLM frequency were detected in all the exposed groups compared with the control one. There was no effect of tritium exposure on breeding efficiency.

230. Mewissen et al. [M12, M13] studied cumulative genetic effects following exposure of male C57BL/6M mice to tritium for six and ten generations. At each generation, weaned male breeders aged 35 days either received a single injection of tritiated thymidine (0.037 MBq/g of body weight) or were exposed for five weeks to HTO (0.37 MBq/mL). The dose to male sperm over a 35-day period of exposure in each generation was estimated at 0.037 Gy from HTO. At 10 weeks of age, all breeders were sibling-mated. At the fifth generation, the average litter size was 6.56 and 6.72 vs. 6.92, respectively, in the sibling line receiving tritiated thymidine, exposed to HTO and in the control. The observed variations are significant at the 0.01% level by chi square test. Also, the average weight of mice at weaning consistently decreased through successive generations in the sibling line exposed to tritiated thymidine and to a lesser extent in those exposed to HTO, whereas individual weight remained fairly constant in control mice. F1 and F2 offspring from the ninth generation were studied for litter size and infant mortality. The litter size had decreased and infant mortality increased in experimental groups. DLM frequency (pre-implantation death) had increased in both experimental groups.

231. Balonov and Kudritskaia studied the frequency of DLMs in germ cells of male randomly bred mice induced by HTO and  $^{137}\text{Cs}$  gamma radiation [B9]. HTO was administered to males by a single intraperitoneal injection and excreted with a half-time of about 2.5 days. In order to adjust exposure conditions, the dose rate of gamma radiation was reduced exponentially with the same half-time. DLM frequency was estimated from the results of four weekly matings of each male with 2–4 intact females beginning from the tenth day after the exposure launch. At 17–18 days after the beginning of mating, the females were dissected and the number of yellow bodies in the ovaries, places of implantation and dead embryos were counted. It was concluded that HTO beta radiation was more effective than  $^{137}\text{Cs}$  gamma radiation (figure XII). RBE values tended to increase with dose and effect reduction: from 1.6 at  $D_{\text{HTO}} = 2$  Gy to 2.2 at  $D_{\text{HTO}} = 0.5$  Gy. Linear extrapolation of RBE dependence on dose to zero gives  $\text{RBE}_{\text{max}} = 2.6$  [B9, B12].

232. In summary, the studies presented here demonstrated that internal exposure of mammal germ cells to HTO can induce DLMs of the progeny at a wide range of radiation doses. RBE estimation showed tritium beta radiation to be more effective than gamma rays for this biological end point by factors of 1.6 to 2.6 [B9, B12].

Figure XII. Frequency of induced post-implantation death of randomly bred mouse embryos depending on dose of  $^{137}\text{Cs}$  gamma radiation (lower curve) and of HTO beta radiation (upper curve) [B9, B12]

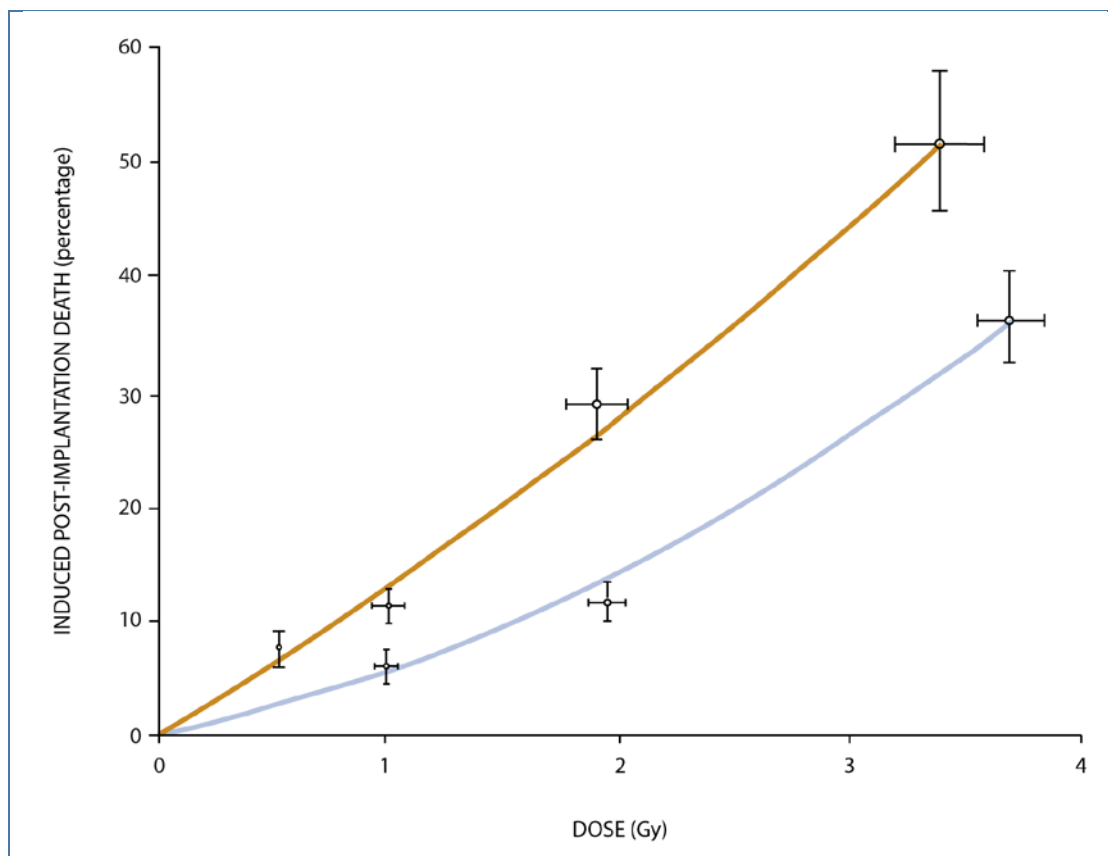

## D. Effects of tritiated biochemical substrates

233. The extent of cellular injury caused by a tritiated biochemical substrate depends largely on where it is incorporated into a cell and the duration of exposure. Tritiated DNA precursors, such as tritiated thymidine, are theoretically more efficient in causing cellular injury because they form part of the basic building block of a DNA strand. This effect was already reported in 1958 by Painter et al. [P1]. On the other hand, compounds containing tritium that are not close to the DNA in the cell, such as fats or some amino acids included in a non-nuclear protein, should pose a lesser risk.

234. Whereas radiobiological studies with HTO aimed mostly at specification of RBE values for either deterministic or stochastic effects in mammals, similar studies with tritiated biochemical substrates aimed to reveal their effects compared with those from HTO. In practical terms, these studies are used for specification of dosimetric models for OBT and tritiated biochemical substrates. It is understood that direct studies of OBT-related biological effects are hardly feasible either in the environment or in experiments on mammals because of low tritium concentration in OBT. Therefore, some tritiated biochemical substrates are used as an experimental surrogate for OBT in food, which is potentially a factor of public exposure.

235. Studies on the effects of nucleotropic forms of tritium such as tritiated DNA-precursors are of special interest because they promote better understanding of radiobiological mechanisms of internal

exposure. In practical terms, their results will be used as scientific bases for future models for the protection of workers dealing with those forms of tritium. However, the number of workers potentially thus exposed is rather limited. Thus, exposure to and incorporation of tritiated thymidine is essentially largely of scientific interest.

## 1. Studies in vivo

236. In experimental studies on mammals, studies have focused on biological effects resulting from tritiated thymidine, the first synthesized tritium-labelled nucleoside, because of its pronounced intranuclear localization in contrast to uniformly distributed HTO. Effects of tritiated amino acids with varied intracellular distribution and of uniformly distributed  $^3\text{H}$ -glucose have been studied to a lesser extent. Deterministic radiation-induced effects were the focus of these studies, except for one series of experiments (table 16) studying stochastic effects in germ cells of male mice, i.e. induction of heritable reciprocal translocations in spermatogonia and non-heritable DLMs.

Table 16. Time-integrated frequency of excess post-implantation embryo death (DLM, % weekdays), frequency of reciprocal translocation (RT) in spermatogonia and relative testis mass reduction (RTMR, %) in one month after injection of HTO and tritiated biochemical substrates in male mice [B9, B10, B12]

Tritium compound	Intake (MBq/g of body weight)	Testis cell dose (Gy)	DLM (%·week)	RT frequency (%)	RTMR (%)
HTO	3.3	1.0	38	0.44±0.20	47±2
Glucose	3.3	0.9	32	0.46±0.16	46±4
Glycine	3.1	1.3	15	0.36±0.11	44±3
D,L-Lysine	3.1	1.5	63	0.38±0.15	51±4
L-Lysine	1.9	2.2	130	0.87±0.22	64±3
Thymidine	0.04	—	10	0.21±0.07	—
	0.4	—	35	0.56±0.20	29±4
	1.1	—	35 <sup>a</sup>	0.44±0.17	—
Deoxycytidine	0.4	—	20	0.12±0.06	14±4
	1.1	—	56	0.26±0.11	35±3
Control	—	—	0	0.025±0.014	0

<sup>a</sup> Low fertility.

237. Lambert [L3] found that the number of resting primary spermatocytes per tubule in rat spermatogonia was halved in 72 hours by exposure to HTO and tritiated thymidine concentrations of 2.2 and 0.55 MBq/g of body mass, respectively, given as a single injection. He pointed out that these values should be viewed with caution owing to uncertainties in several factors, such as the time of death of the spermatogonia and, therefore, the dose from tritium that induced it.

238. Baker and McLaren studied effects of tritiated thymidine on the developing oocytes of randomly bred Q strain mice [B4]. Following seven intraperitoneal injections of pregnant mice with  $^3\text{H}$ -thymidine (0.15, 1.5 and 15 MBq per injection), tritium label was detected in the ovaries of their progeny. The total number of oocytes in the ovaries was reduced in all the exposed groups proportionally to injected tritium activity. The primordial oocytes were more affected than multilayered follicles. Other functions

(e.g. body weight, fertility, ovarian weight) were affected only in the group with the highest injected activity. It was concluded that mouse oocytes are highly sensitive to beta radiation from incorporated  $^3\text{H}$ -thymidine during embryonic life.

239. In the experiments of Carr and Nolan [C9] on reduction of testis mass of the mouse following single injections of tritiated thymidine (0.037–0.74 MBq/g of body mass) or HTO (or exposed to  $^{60}\text{Co}$  gamma rays), a significant effect on the testis mass was seen after the injection of tritiated thymidine at 0.037 MBq/g of body mass, which delivered an estimated average absorbed dose to the testis of about 0.035 Gy during 16 weeks. The authors assessed that tritium from tritiated thymidine “fixed” in the testis was about twice as effective as the more labile and uniformly distributed tritium from HTO and that, in terms of injected amount tritiated thymidine, it is unlikely to be more than five times as effective as HTO even at very low injected amounts.

240. Balonov et al. [B12], in a series of experiments on randomly bred male mice, studied both reduction of testis mass and frequency of DLMs in germ cells induced by  $^3\text{H}$ -glucose, two amino acids ( $^3\text{H}$ -glycine and  $^3\text{H}$ -lysine) and two nucleosides ( $^3\text{H}$ -thymidine and  $^3\text{H}$ -deoxycytidine) following intraperitoneal injections. Tritiated glucose and amino acids were administered in single injections and nucleosides in six portions during three days. In the post-sterile period, three–five months after exposure commenced, ten–twelve males from each experimental group and four–five males from control groups were sacrificed and reciprocal translocations in mouse stem spermatogonia counted. The effects were assessed in comparison with HTO [B9, B10]. For injected tritiated nucleosides, the concept of tissue or cell dose was not applied. The main results of experiments are presented in table 16. As the time dependence of DLMs was different following administration of HTO and various tritiated substrates, especially the nucleotropic forms, the presented parameter is time-integrated excess post-implantation embryo death.

241. The administration of all the tested tritiated substrates resulted in the production of three radiobiological effects that are qualitatively similar to those observed for HTO. As far as the time-integrated DLM frequency is concerned, the order of effectiveness of the various chemical forms, per unit of injected activity per gram of body weight, is as follows:  $^3\text{H}$ -glycine – HTO and  $^3\text{H}$ -glucose – D,L-lysine- $^3\text{H}$  –  $^3\text{H}$ -deoxycytidine – L-lysine- $^3\text{H}$  –  $^3\text{H}$ -thymidine. DLM frequencies induced by labelled lysine, thymidine, and deoxycytidine are five–eight times higher than that from an equal HTO activity. Per unit of testis dose,  $^3\text{H}$ -glycine is three times less effective than HTO,  $^3\text{H}$ -glucose and  $^3\text{H}$ -D,L-lysine do not differ from HTO, and  $^3\text{H}$ -L-lysine is more effective by a factor of 1.5. The difference in genetic efficiency will not only reflect different dynamics of retention of bound tritium in the testes but also its different location with regard to the cell nucleus. The nuclear location of  $^3\text{H}$ -nucleosides and  $^3\text{H}$ -lysine is well established, and the suggestion of a predominantly extranuclear location of  $^3\text{H}$ -glycine in germ cells is consistent with observations. In contrast to DLM, reciprocal translocation frequencies in stem spermatogonia reflect late mutagenic effects of tritium. The deterministic effect of testis mass reduction at one month after tritium injection generally agrees with assessed testis doses [B9, B10, B12].

242. In summary, experiments on rodents with administration of biochemical substrates labelled with tritium confirmed the theoretical consideration that some of them are more efficient with regard to induction of both deterministic (cell death) and stochastic (mutation) effects compared with administration of equal activities of HTO. Per unit of intake,  $^3\text{H}$ -thymidine is 5–10 times more efficient than HTO. The experiments also demonstrated elevated efficiency of other nucleotropic forms of tritium, L-lysine- $^3\text{H}$  and  $^3\text{H}$ -desoxycytidine. For  $^3\text{H}$ -labelled nucleosides, the application of concepts of tissue and cell dose is hampered by lack of data on their distribution in mammalian cells.

## 2. Studies in vitro

243. In 1973, Snow [S16] showed that tritiated thymidine at activity concentrations between 0.37 and 3.7 kBq/mL (0.01 and 0.1  $\mu$ Ci/mL) significantly reduced the number of cells in mouse blastocysts cultivated in vitro after exposure starting during the two-cell stage. Activity concentrations exceeding 3.7 kBq/mL were lethal to the two-cell embryos. Several other authors have published consistent findings [H11, K10, M23, O5, S21].

244. By incubating embryos in solutions of tritiated thymidine, Streffer et al. [S24] found that an activity concentration of 18.5 kBq/mL almost completely inhibited the development of mouse blastocysts and was about 1,000 times more effective than similar activity concentrations of HTO. Similarly, they found that activity concentrations of 1.85 MBq/mL of HTO and 1.85 kBq/mL of tritiated thymidine reduced the yield of fully developed blastocysts to 50–60%.

245. The extreme ratios of “toxicity” reported refer to concentrations of tritium in the culture media rather than dose to cells. In fact, Streffer et al. [S24], when culturing blastocysts, estimated that tritiated thymidine at a concentration of 1.85 kBq/mL resulted in a dose rate to DNA of 70 mGy/h and its effect was similar to that of 1.85 MBq/mL of HTO, which gave a (uniform) dose rate of 60 mGy/h. The tritiated thymidine in these in vitro cultures was available for the duration of the experiment, thus resulting in the labelling of all DNA synthesis in the developing embryo. This situation is different from the situation that might arise in vivo. This was referred to by Furuno-Fukushi [F14].

246. Particularly interesting are those papers that compared the effects of exposure to different tritiated compounds. Clerici et al. [C22] compared the toxicity of tritiated thymidine with that of the toxicity of four tritiated amino acids; arginine, lysine, histidine and aspartic acid with regard to growth and development of two-cell mouse embryos exposed in vitro. Surprisingly, arginine was the most lethal of all the tritiated compounds, requiring 1.1 kBq/mL of medium to kill 50% of the embryos. In comparison, tritiated thymidine had an LD<sub>50</sub> of about 3.0 kBq/mL. The LD<sub>50</sub> of the other amino acids was 2.2 kBq/mL for lysine, 4.8 kBq/mL for histidine and 14.8 kBq/mL for aspartic acid. The LD<sub>50</sub> for tritiated tryptophan (1 kBq/mL) was almost the same as that for tritiated arginine [K12]. The authors commented that this was surprising because tryptophan was not excessively incorporated into histones. However, two non-histone chromosomal proteins with high amounts of tryptophan were identified.

247. Similarly, in vitro experiments performed by Müller et al. [M24] on preimplantation mouse embryos have shown that, given the heterogeneous distribution and specific incorporation into DNA, tritiated thymidine is 1,000–5,000 times more effective than HTO in inducing harmful effects at the same level of applied activity concentration. Müller et al. also found that tritiated arginine, a histone precursor, was more damaging than tritiated thymidine for a number of in vitro end points in the mouse embryo, including blastocyst formation, hatching of blastocysts, trophoblast outgrowth, inner cell mass formation, number of cells per embryo and micronucleus formation. The mice embryos were incubated in vitro in solutions with activity concentrations of 0.37 kBq/mL and 0.93 kBq/mL of both tritiated arginine and tritiated thymidine. The authors postulated that the greater radiotoxicity of the tritiated arginine was due to faster uptake and possibly because histone synthesis is not restricted to the S phase of the cell cycle while thymidine would be incorporated only during DNA synthesis. The latter assumption was confirmed some years later in cell-cycle specific experiments [M25]. These studies emphasize the importance of understanding the intracellular distribution of tritium-labelled biochemicals, with effects relating more directly to nuclear dose than to averaged cell or tissue dose or to levels of administered activity.

248. Furuno-Fukushi et al. [F14] treated lymphocytic leukaemia cells of mice for 50 hours with various tritiated compounds: thymidine, lysine, arginine, leucine, and aspartic acid. Cell doses for HTO

and tritiated amino acids or nucleus doses for  $^3\text{H}$ -thymidine ranged from approximately 0.1 to 8 Gy (as interpreted from graphical data). Cell survival decreased exponentially with increased substrate activity concentration in culture medium for all compounds with the effects being greatest for thymidine, followed by arginine, lysine, leucine and aspartic acid whereas cell-mutation frequencies increased linearly. The concentrations for detectable cell killing and mutagenesis were about 37 kBq/mL for tritiated thymidine, 37–370 kBq/mL for tritiated amino acids and 18.5–185 MBq/mL for HTO. When activities in cells were measured and converted to dose in cells for tritiated amino acids and dose in nuclei for  $^3\text{H}$ -thymidine, the response both in terms of cell survival and mutation frequency per unit dose was estimated equal for all amino acids; however, elevated by a factor of 2–3 for  $^3\text{H}$ -thymidine.

249. Wang et al. [W4] examined the effects of tritiated biochemical substrates on cultured embryonic mid-brain cells of mice using the following tritiated compounds: thymidine, uridine, arginine and glutamic acid. The cells were exposed to different concentrations of these compounds over a 20-hour period. Assays of cell proliferation and differentiation and DNA and protein content were conducted. Contrary to the studies by Müller et al. [M24] and Clerici et al. [C22], Wang and Zhou [W3, W4] found that both tritiated thymidine and tritiated uridine were more radiotoxic than tritiated arginine and tritiated glutamic acid. This was probably due to the different biological end points studied. Table 17 provides a summary of the effects of exposure to the tritiated compounds measured as the tritium activity concentration ( $\text{ID}_{50}$ ) in the culture medium and corresponding dose for cells or nuclei (the latter for  $^3\text{H}$ -TdR) necessary to inhibit the cellular processes (proliferation and differentiation) by 50%. Tritiated thymidine behaved very differently from the other three tritiated compounds, with a much steeper dose–response curve. This is evident in table 17 where the  $\text{ID}_{50}$  for tritiated thymidine is much lower. However, corresponding absorbed doses for cells or nuclei do not vary much whether the tritium-labelled substance is distributed uniformly or concentrated in the nucleus as is  $^3\text{H}$ -thymidine.

Table 17. Inhibitory effect of beta radiation from tritiated biochemical substrates on cellular proliferation and differentiation [W4]

OBT	Proliferation		Differentiation	
	$\text{ID}_{50}$ (kBq/mL)	Absorbed dose (Gy)	$\text{ID}_{50}$ (kBq/mL)	Absorbed dose (Gy)
$^3\text{H}$ -Thymidine	29	0.58	21	0.42
$^3\text{H}$ -Arginine	193	0.85	163	0.66
$^3\text{H}$ -Uridine	193	0.60	141	0.43
$^3\text{H}$ -Glutamic acid	525	0.95	438	0.77

250. In summary, incubating mammalian cells and embryos in media containing biochemical substrates labelled with tritium may result in various biological effects, such as death of cells and embryos, cell mutations and inhibited proliferation and differentiation. The radiobiological efficiency of these outcomes, assessed per unit labelled substrate concentration in culture media, varies by a factor of up to 1,000 compared with HTO and by a factor of up to some tens between substrates. These differences reflect the active involvement of labelled biochemical substrates in biochemical processes that lead to incorporation of tritium into cell organelles and subsequent exposure of cells and nuclei (such as in the case of labelled DNA precursors) with tritium beta radiation. However, the radiobiological efficiency of the different substrates is comparable when assessed per unit of cell or nuclei radiation dose.

### 3. Biophysical models

251. In order to study the impact of tritiated biochemical substrates or OBT, Chen [C14] performed microdosimetric simulations to compare differences in energy deposition between uniform distribution of tritium within a cell (as expected with HTO) and a non-uniform distribution based on the assumption that all OBT was bound uniformly within biologically critical sites of dimensions from 10 nm to 2  $\mu\text{m}$ . The dose mean lineal energies within these critical targets were calculated to be a factor of 1.7 higher for OBT bound to the critical site compared to HTO over a wide range of target dimensions. This effect results from a localized increase in dose to the critical target due to a non-uniform distribution of energy deposition within the cell. However, the extent of any increase would depend on the extent to which OBT preferentially localizes within critical targets.

252. Alloni et al. [A1] simulated radiobiological effects of tritium concentration, depending on its chemical form, either in the cytoplasm or in the nucleus of the target cell. The biophysical track-structure code PARTRAC was used to calculate nuclear doses, DNA damage yields and fragmentation patterns for different localization of tritium in human interphase fibroblasts. For tritium distributed selectively in the cytoplasm but excluded from the cell nucleus, the dose in the nucleus is 15% of the average dose in the cell. In the low- and medium-dose regions investigated in the paper, numbers of double-strand breaks (DSBs) are proportional to the nuclear dose, with about 50 DSB/Gy. These results illustrate the potential for over- or underestimating the risk associated with tritium intake when its distribution at subcellular levels is not appropriately considered.

253. In summary, while many studies have examined how tritiated biochemical substrates are partitioned within the body and within the cell, studies specifically looking at health effects due to exposure to those substances are limited. Those that are available indicate that most organic compounds have about the same effectiveness as HTO, since they are distributed throughout cells and do not lead to preferential irradiation of the nucleus. Incorporation of some tritiated amino acids and tritiated nucleosides (e.g. thymidine), however, can lead to the accumulation of tritium in the nucleus with longer retention times and a proportionately larger dose per unit intake.

## VII. RELATIVE BIOLOGICAL EFFECTIVENESS

254. The RBE is the ratio of the absorbed dose of a reference radiation needed to cause a specific biological response divided by the absorbed dose of the radiation of interest that causes the same response. RBE values are experimentally observed values and differ for particular radiation types according to the biological system and end point under consideration, dose, dose rate, and the reference radiation. RBE values are the basis for but have to be distinguished from the concept of radiation weighting factors ( $w_R$ ) used by ICRP in the calculation of equivalent and effective doses, in which simplifications are made that are considered appropriate by ICRP for protection purposes. In radiological protection, the RBE for stochastic effects at low doses ( $\text{RBE}_M$ ) is of particular interest.

255. RBE data and biophysical considerations (see below) indicate that lower energy electrons (such as those released by tritium) or photons are biologically more effective than higher energy gamma rays for a range of deterministic and stochastic end points. Although ICRP [I13, I23] recognized that there was evidence for a significant variation in RBE values for low-LET radiation (e.g. increasing RBE with decreasing photon energy), it was argued that a more detailed distinction was not warranted for the purposes of radiological protection. Thus, a value for  $w_R$  of 1 was chosen for practical reasons to apply to all electrons and photons, including beta particles from tritium [C30].



## A. Track structure considerations

256. Tritium decay results in the production of a very low-energy beta particle (average energy 5.7 keV) of short range (average track length in water 0.56  $\mu\text{m}$ ) and, as a result, the average ionization density (and LET) produced by the emitted beta particle is significantly higher than that produced by higher energy electrons or photons, such as  $^{60}\text{Co}$  gamma rays (see table 18). Lower energy photons or electrons similar to those produced by tritium decay also show a significant shift in microdosimetric energy deposition patterns towards higher lineal energy ( $y$ ) compared to higher energy photon or electron fields. The spectra of energy deposition in low-pressure proportional counters over a range of simulated tissue site sizes for tritium, 250 kVp X-rays and  $^{60}\text{Co}$  gamma rays were measured by Ellett and Braby [E2]. The results were then interpreted using the earlier site model of the Kellerer-Rossi theory of dual radiation action (DRA) (e.g. [K7]) to estimate the RBE value for limiting low doses. The DRA model simply assumes that the biological effect is proportional to the square of the energy deposited in some small volume, often taken to be about 1  $\mu\text{m}$  in diameter. They reported theoretical RBE values for tritium of 3.75 compared to  $^{60}\text{Co}$  gamma rays and 1.5 compared to 250 kVp X-rays (half-value layer 1.8 mm Cu), assuming a critical site size of 1  $\mu\text{m}$ .

Table 18. Track average LET,  $\overline{L}_{\Delta}$ , in water for various radiations based on a cut-off energy,  $\Delta$ , of 100 eV [I24]

Radiation	$\overline{L}_{\Delta}$ (keV/ $\mu\text{m}$ )
$^{60}\text{Co}$ gamma rays	0.22
200 kV X-rays	1.7
$^3\text{H}$ beta rays	4.7
50 kV X-rays	6.3

257. On the nanometre scale also, analysis of the energy deposition patterns of tritium beta particles has shown tritium to be more effective in producing larger sized clusters of ionization which can be enfolded within a 2.3 nm diameter sphere compared with photons with energies above 100 keV [M17]. This represents ionization events on the dimensional scale of DNA.

258. A joint task group of ICRP and the International Commission of Radiation Units and Measurements suggested a relationship between what the group called a quality factor,  $Q(y)$ , and lineal energy,  $y$ , defined as the energy imparted in a 1  $\mu\text{m}$  diameter spherical tissue volume divided by its mean chord length [I25]. The relationship was based in part on general observations and theoretical considerations, with special consideration given to the experimental data on chromosome aberrations in human lymphocytes. The value of  $Q(y)$  obtained for tritium beta particles was approximately 2 compared to orthovoltage X-rays. This is supported by theoretical calculations performed by Bigildeev et al. [B19] on the basis of similar microdosimetric quantities on the micrometre scale.

259. Morstin et al. [M20] calculated the lineal energy spectra of tritium beta particles for spherical sites with diameters from 1 nm to 10  $\mu\text{m}$  and showed that the mean values varied by more than an order of magnitude over this range. Then, when they applied the assumptions of the site model of DRA theory, they found that the predicted RBE of low doses of tritium beta particles relative to 250 kVp X-rays rose from a value of <1.1, for assumed 10 nm sensitive sites, to a peak of ~1.5 for 1  $\mu\text{m}$  and then decreased to ~0.6 for 10  $\mu\text{m}$ . The corresponding predicted RBE value of tritium beta radiation relative  $^{60}\text{Co}$  gamma rays was ~1.5 for 10 nm sites, ~2.9 for 1  $\mu\text{m}$  and ~1.6 for 10  $\mu\text{m}$ . Morstin et al. [M20] pointed out limitations of the DRA approach and they also considered the possibility of two different pathways

of radiation damage related to two different target sizes. They produced bidimensional correlated distributions of lineal energy for spherical sites of 10 nm and 20 nm diameter (to represent DNA double-strand break formation) within a gross sensitive volume of 1  $\mu\text{m}$  diameter. By then “assuming arbitrarily (by somewhat questionable analogy to the DRA theory)” a squared dependence of RBE on the product of the lineal energies for the large and small sites, they obtained estimated theoretical RBE values for tritium compared to 250 kVp X-rays of 1.6 for the 10 nm sites, and 1.8 for the 20 nm sites, within the 1  $\mu\text{m}$  gross sensitive volumes.

260. In a recent theoretical study, Chen [C16] performed microdosimetric simulations to compare dose mean lineal energies for HTO and OBT with that for  $^{60}\text{Co}$  gamma rays in the same size range from 10 nm to 2  $\mu\text{m}$  of spherical radiosensitive sites. Compared with  $^{60}\text{Co}$  gamma rays, the estimated RBE value varied from 1.3 to 3.5 for HTO and for 2.3 to 5.6 for OBT.

261. Most of the above theoretical calculations of RBE values are based on the assumptions of uniform interaction between pairs of elementary biological “sub-lesions” within sensitive sites of approximately 1  $\mu\text{m}$ . However, a number of experimental investigations have indicated that the biological effectiveness of radiation at low doses is determined predominantly by patterns of energy deposition over much smaller distances down to nanometre dimensions and, therefore, micrometre sized simulated volumes will not typically provide an adequate description of these patterns [G3, G5, G12, K8].

262. The effectiveness of low-energy electrons, similar to those produced by tritium, can be studied using ultrasoft X-rays (0.1–5 keV) that interact in the cell to produce low-energy electrons. Data from a range of laboratories around the world, with few exceptions, show ultrasoft X-rays to have increased effectiveness for a wide range of biological end points compared to equal doses of conventional X-rays or gamma rays [G6, G7, H10], with RBE values typically increasing with decreasing ultrasoft X-ray energy down to  $\text{C}_K$  X-rays (0.28 keV; producing a single photoelectron with a range less than 7 nm). RBEs greater than unity were also found for  $\text{Ti}_K$  and  $\text{Cu}_K$  X-rays with energies (4.5 keV and 8.0 keV, respectively) similar to the average energy of the emitted beta particle from tritium.

263. Hill [H11] reviewed several studies that looked at in vitro end points, such as dicentric aberrations in human chromosomes, micronuclei induction, and mutations over a range of photon energies from ultrasoft X-rays to  $^{60}\text{Co}$  gamma rays. He observed a pronounced trend of an increase in RBE values with decreasing photon energy for several biological end points, particularly for the induction of dicentrics in human lymphocytes. He noted that, because of differences in cell types and biological end points, the extent to which lower photon energy caused RBE values to rise was still uncertain. Recent data by Frankenberg et al. [F11] report an  $\text{RBE}_M$  (maximum RBE value for very low doses) of about 4 for soft (mammography) X-rays compared to 200 kVp X-rays.

264. The percentage of absorbed dose deposited by low-energy electrons (0.1–5 keV) in tissue is ~33% for  $^{60}\text{Co}$  gamma rays, ~49% for 220 kV X-rays and rising to ~78% for tritium beta particles [N5]. These are similar to the low-energy electrons produced by ultrasoft X-rays. It has been inferred that these low-energy secondary electron track ends produced by low-LET radiation are the predominant cause of DSB induction, cell inactivation and other cellular effects, with isolated sparse ionizations and excitations apparently having little biological effect [B24, G6]. The contribution to absorbed dose of these low-energy electrons is large for tritium beta particle compared to orthovoltage X-rays or gamma rays. Therefore, the ultrasoft X-ray data would predict an increase in biological effectiveness as a result of increased clustering of ionization events on the nanometre (DNA) scale leading to an increase in the number of DSB per unit absorbed dose, along with a slight increase in complexity of the breaks due to additional associated damage within a few base pairs.

265. Using Monte Carlo simulation, Moiseenko et al. [M18] modelled DSBs and single-strand breaks (SSBs) in cells exposed to tritium beta particles and low-energy photons. They found that a direct energy deposition of 10 eV could result in an SSB. They further studied base damage associated with DSB and were able to differentiate between simple DSBs and complex DSBs. They later developed a Monte Carlo model to calculate yields of DSBs in DNA after irradiation with  $^{137}\text{Cs}$  gamma radiation, orthovoltage X-rays (typically 150–300 kVp) and tritium beta particles [M19]. The RBE values for DSB production for tritium beta radiation (with  $^{137}\text{Cs}$  gamma radiation as the reference) was 1.2 for the total DSB yield and 1.3 for complex DSBs. They explained that low-energy X-rays and tritium beta particles tended to deposit energy in a more clustered fashion than  $^{137}\text{Cs}$  gamma rays. They concluded that tritium beta particles were more efficient in producing DSBs in DNA compared to  $^{137}\text{Cs}$  gamma rays and that their relative effectiveness was even greater for the production of complex DSBs.

266. In summary, track structure considerations suggest that the low-energy beta particles produced by tritium decay are more biologically effective than hard X-rays and gamma rays per unit absorbed dose, at least in producing DSBs in DNA. This is a result of the average ionization density along the track of the tritium beta particle being significantly higher than produced by much higher energy photons. Theoretical calculations based on microdosimetric considerations suggest an RBE value of approximately 2, relative to  $^{60}\text{Co}$  gamma rays.

## B. RBE literature reviews and experimental studies

267. In studies aimed at deriving values of RBE for tritium beta radiation, there is the potential for the values obtained to depend on the total dose and rate at which dose from both tritium and the reference radiation are delivered. In the case of  $^3\text{H}$ , the dose is expected to be protracted in time since the dose rate is dictated by the rate of tritium loss from the body and, to lesser extent, by its radioactive disintegration. Experiments using X- or gamma rays, on the other hand, often deliver dose in a single acute exposure because this is more convenient in practice. It is generally accepted that the same dose delivered in a protracted manner can have a lower effect than an acute dose would, due to the greater opportunity for DNA repair in the protracted case [I13, N3, N7, U7, U8].

268. Most of the lower values for the RBE of tritium reported in the literature are from studies that used higher doses and dose rates of the reference radiation. This trend can be explained by the high dose rate of the reference radiation reducing the apparent relative effectiveness of the tritium doses. A review of tritium RBE studies was carried out by Ujeno [U2] illustrated this phenomenon. Those studies, which included external reference radiation, showed a tendency for an inverse relationship between dose rate and RBE value. The author concluded that use of a RBE value of 1 would be reasonable for assessing the dose from a very large intake of tritium but that a figure larger than 1 would be more appropriate for environmental and occupational exposure situations. Therefore, the differences in RBE values can be viewed assuming that the response at high acute doses is less dependent upon or is independent of photon/electron energy.

269. In numerous studies of tritium radiobiological effects conducted since the early 1960s, the focus has been on the RBE values for the tritium beta radiation for assessing stochastic health risks (primarily cancer induction and heritable effects) of lower doses in mammals to be used in radiation protection of humans and environment. Those studies were carefully reviewed by several groups of authors over the past two decades [H16, K20, L12, O1, P2, S23].

270. Straume and Carsten [S23] provided a comprehensive review of the literature on the carcinogenic, heritable, developmental and reproductive effects associated with tritium exposure. They identified 33 published studies on the RBE of the tritium beta radiation using HTO: 12 studies used X-rays (200–500 kVp) as the reference radiation; 21 studies used gamma rays from  $^{137}\text{Cs}$  or  $^{60}\text{Co}$  as the reference radiation. Combining these studies, they calculated an arithmetic mean of 1.8 and 2.3 for the range of RBE values when X-rays and gamma rays, respectively, were used as the reference radiation.

271. The AGIR report [H16], discussed RBE values of tritium beta radiation and also the relationship between RBE value and the dose and dose-rate effectiveness factor (DDREF), the use of different reference radiation, and some experimental studies. They noted that the RBE values for tritium beta radiation using HTO from a wide variety of cellular and genetic studies were generally found to be in the range of 1–2 when X-rays were the reference, and 2–3 when gamma rays were the reference.

272. Little and Lambert [L12] subsequently conducted a comprehensive analysis of several peer-reviewed studies with the intent of determining maximum low-dose RBE values, denoted  $\text{RBE}_M$ . The biological end points of these tritium studies included carcinogenesis, chromosomal aberration, and cell death. The studies were divided into *in vivo* and *in vitro* experiments, and subdivided further according to whether the reference exposure was prolonged or acute. To be classified as a prolonged exposure, the external irradiation dose rate had to be comparable to that for exposure to tritium. The authors concluded that the overall aggregated results implied RBE values with a central estimate in the range of 1.2–2.5 and a 97.5 upper percentile of no more than 3.0. The six studies with prolonged gamma radiation as reference exposure and end points apart from cell survival yielded aggregate RBE values of 2.19 (95% CI: 2.04, 2.33) versus 1.17 (95% CI: 0.96, 1.39) when chronic X-rays were used as reference radiation.

273. A review of RBE values by Kocher et al. [K20] was conducted to support assessments of cancer risk from known exposure to ionizing radiation and estimation of the probability of causation. A defining characteristic of analysis of data on RBEs by these authors was that estimates of radiation effectiveness factors were expressed as subjective probability distributions to represent uncertainty arising from uncertainties in the underlying estimates of RBE values.

## C. Factors affecting RBE values

274. The reference radiation types used in RBE studies were 150–250 kVp X-rays, and gamma radiation from  $^{60}\text{Co}$  (1,173 and 1,332 keV) or  $^{137}\text{Cs}$  (662 keV). However, studies such as those by Bond et al. [B23], Sasaki [S3] and Schmid [S6] reported in the ICRP Publication 92 [I20], demonstrated that orthovoltage X-rays are typically about twice as effective at low doses as are high energy gamma rays and that this difference is consistent with biophysical calculations [E2, K9].

275. Straume and Carsten [S23] discussed this issue, indicating that RBE can vary significantly with changes in dose rate and radiation quality. Furthermore, as noted by AGIR [H16], the dose–response curve for acute doses of low-LET reference radiation is often curvilinear in relation to the response to radiation with higher LET. This curvilinearity of response to reference radiation in the low-dose range means that the RBE between the two types of radiation is maximum at lower doses. The maximal RBE value is referred to as the  $\text{RBE}_M$ .

276. Cell mutations and chromosome aberrations represent chromosome damage that could lead to cancer development. However, as Little and Lambert [L12] noted, chromosome damage may be only one of many steps in carcinogenesis. Hill [H11] also pointed out that many studies used the induction of

dicentric aberrations as an end point because it was a reliable and repeatable method for comparing biological response, recognizing that this was a short-term effect not directly relevant to quantitative assessment of long-term stochastic effects.

277. The yield of DSBs is considered to be strongly dependent on biological systems and cellular environments and has been used for RBE determinations. After reviewing data on DSB yields for low-energy electrons and high-energy protons of comparable microdosimetric characteristics to those of tritium in the dimensions relevant to DSBs, Chen [C15] estimated that average yields of 2.7, 0.93, 2.4 and  $1.6 \times 10^{-11}$  DSBs/Gy·Da were reasonable estimates of DSB yields for tritium in plasmid DNAs, yeast cells, Chinese hamster V79 cells and human fibroblasts, respectively. If a biological system is not specified, the DSB yield from tritium exposure can be estimated as a simple average over experimentally determined yields as  $2.3 \pm 0.7 \times 10^{-11}$  DSBs/Gy·Da in various biological systems.

## D. Summary of RBE value determinations

278. In summary, about 50 different experimental estimates of the RBE values for the tritium beta radiation in animals or animal cells have been reported that ranged from 1.0 to 5.0 (centred around 2-2.5) and 0.4-8.0 (centred around 1.5-2) with gamma rays and orthovoltage X-rays as reference radiation, respectively. There is tendency for RBE values to increase with decreasing doses. RBE values derived from stochastic effect studies are generally higher (centred around 2.5-3 compared with prolonged gamma radiation) than those obtained from studies of deterministic effects (cell killing in vivo and in vitro). Considerable variation from one experiment to another exists. Only three experimental studies directly addressed carcinogenic effects in mammals. In addition to experimental uncertainty and the choice of a reference radiation, a number of other factors contribute to this variability, including differences in radiosensitivity of tissues, organs and organisms; differences in the biological end points; variation in dose and dose rate; and choice of in vitro or in vivo test systems.

279. Tables 19 to 22 provide summaries of the studies of the RBE of tritium beta radiation in mammals, the studies being grouped by the experimental condition (in vivo studies in tables 19 and 20, and in vitro studies, including murine and human cells, in tables 21 and 22) and according to the type of radiation used as reference (X-rays in tables 19 and 21, and gamma rays in tables 20 and 22). In all the listed studies, tritium was used in HTO form. Tables 19 and 22 present studies in chronological order with both stochastic and deterministic end points; these are separated in summary table 23. When two or more end points or various exposure conditions were used in the same study, they are presented in tables as separate studies.

280. Using the data from some of these studies, Little and Lambert [L12] recalculated RBE values for the tritium beta radiation and their results are also provided in the tables 19 to 22 and used in summary table 23.

Table 19. In vivo studies using X-rays as reference radiation

<i>Study reference</i>	<i>Biological end point</i>	<i>Exposure conditions</i>	<i>Reference radiation</i>	<i>Dose range (Gy)</i>	<i>RBE values for the tritium beta radiation (95% CI where indicated)</i>
Lambert [L3]	Spermatogonial survival in mice	Single injection of HTO and prolonged X-rays	200 kVp X-rays	0.05 tritium beta 0.11 X-rays	2.3
Gragtmans et al. [G9]	Cumulative incidence of mammary tumours in S-D rats	Five HTO injections every two days and acute and prolonged X-rays	200 kVp X-rays	0.46–3.85 tritium beta 0.57–1.78 X-rays (acute) 0.29–2.00 X-rays (prolonged)	0.68 1.1–1.3
Gragtmans et al. [G9]	Cumulative percentage of mammary tumours in S-D rats	Five HTO injections every two days and acute and prolonged X-rays	200 kVp X-rays	0.46–3.85 tritium beta 0.57–1.78 X-rays (acute) 0.29–2.00 X-rays (prolonged)	0.83 n.a.
Chopra and Heddle [C21]	Chromosome aberrations in peripheral blood in female mice	Single injection of HTO and prolonged X-rays	250 kVp X-rays	2.0–6.0 tritium beta 1.5–6 X-rays	1.14 (0.8–1.5)
Chopra and Heddle [C21]	Chromosome aberrations in spermatogonia in mice	Single injection of HTO and prolonged X-rays	250 kVp X-rays	1.5–4.5 tritium beta 1.5–4.5 X-rays	1.21 (0.8–1.9)
Johnson et al. [J5]	Myeloid leukaemia in mice	Single injection of HTO and prolonged X-rays	200/150 kVp X-rays	0.85–3.04 tritium beta 1.06–2.64 X-rays	1.24 (0.63–1.85)
Kozlowski et al. [K24]	Chromosome aberrations in bone marrow in mice	Continuous intake of HTO and acute X-rays	250 kVp X-rays	0.6 tritium beta 0.5 X-rays	1–2 0.43 (0.20–0.81) <sup>a</sup>

<sup>a</sup> Recalculated value by Little and Lambert [L12].

Table 20. In vivo studies using gamma rays (prolonged irradiation) as reference radiation

<i>Study reference</i>	<i>Biological end point</i>	<i>Exposure conditions</i>	<i>Reference radiation</i>	<i>Dose range (Gy)</i>	<i>RBE values for the tritium beta radiation (95% CI where indicated)</i>
Furchner [F13]	Mortality in mice	Single injection of HTO and prolonged gamma	Cobalt-60 gamma (tritium simulator)	5.3–16.5 tritium beta 12.3–16.5 gamma	1.7
Dobson and Kwan [D6, D7]	Oocyte survival in mice	Continuous intake of HTO and prolonged gamma	Cobalt-60 gamma (tritium simulator)	0.07–0.88 tritium beta 0.22–1.25 gamma	2.8
Carr and Nolan [C9]	Testes weight loss in mice	Single injection of HTO and prolonged gamma	Cobalt-60 gamma (tritium simulator)	0.14–0.58 tritium beta 0.58 gamma	1.43 (1.06–1.80)
Russell et al. [R17]	Seven specific locus mutations in F1 mice from spermatogonia exposure	Single injection of HTO and prolonged gamma	Caesium-137 gamma 0.4 Gy/h	6–9 tritium beta	2.2
Balonov et al. [B10]	Testes weight loss in mice	Single injection of HTO and prolonged gamma	Caesium-137 gamma (tritium simulator)	0.12–3.4 0.25–3.7	1.8–2.2
Balonov et al. [B9, B12]	Dominant lethal mutations in male mice	Single injection of HTO and prolonged gamma	Caesium-137 gamma (tritium simulator)	0.5–3.4 tritium beta 1.0–3.7 gamma	1.6–2.2 RBE <sub>M</sub> = 2.6
Pomerantseva et al. [P10] and Balonov et al. [B12]	Reciprocal translocations in mice spermatogonia	Single injection of HTO and prolonged gamma	Caesium-137 gamma (tritium simulator)	0.5–3.4 tritium beta 1.0–3.7 gamma	1.8
Zhou et al. [Z5]	Dominant lethal mutations in female mice	Single injection of HTO and prolonged gamma	Cobalt-60 gamma (tritium simulator)	0.04–0.91 tritium beta 0.53–2.7 gamma	2.5 2.94 (2.00–4.28) <sup>a</sup>
Ijiri [I26]	Apoptosis of small intestinal cells in mice	Single injection of HTO and prolonged gamma	Caesium-137 gamma (tritium simulator)	0.0–0.29 tritium beta 0.0–2.9 gamma	2.1 (1.7–2.5) 1.6 (1.2–2.0) <sup>a</sup>
Ijiri [I26]	Apoptosis of descending colon cells in mice	Single injection of HTO and prolonged gamma	Caesium-137 gamma (tritium simulator)	0.0–0.2 tritium beta 0.0–0.4 gamma	1.8 (1.4–2.2) 1.4 (1.2–1.6) <sup>a</sup>
Satow et al. [S5]	Oocyte killing in mice	Single injection of HTO and prolonged gamma	Caesium-137 gamma, (tritium simulator)	0.04–0.25 tritium beta 0.04–0.25 gamma	1.1–3.5
Satow et al. [S5]	Teratogenic effects on rat embryos	Single injection of HTO and prolonged gamma	Caesium-137 gamma (tritium simulator)	2.0–6.0 tritium beta 1.75–6.8 gamma	2.6 1.01 (0.57–1.78) <sup>a</sup>
Zhou et al. [Z6]	Dominant lethal mutations-oocytes	Single injection of HTO and prolonged gamma	Cobalt-60 gamma (tritium simulator)	0.2–0.6 tritium beta 0.7–2.7 gamma	2.8–3.4
Zhou et al. [Z6]	Dominant lethal mutations-spermatocytes	Single injection of HTO and prolonged gamma	Cobalt-60 gamma (tritium simulator)	0.2–0.6 tritium beta 0.7–2.1 gamma	1.6–3.9
Zhou et al. [Z6]	Dominant skeletal mutations-spermatogonia	Single injection of HTO and prolonged gamma	Cobalt-60 gamma (tritium simulator)	0.2–0.6 tritium beta 0.7–2.9 gamma	3.5–3.9

<i>Study reference</i>	<i>Biological end point</i>	<i>Exposure conditions</i>	<i>Reference radiation</i>	<i>Dose range (Gy)</i>	<i>RBE values for the tritium beta radiation (95% CI where indicated)</i>
Zhou et al. [Z6]	Oocyte survival	Single injection of HTO and prolonged gamma	Cobalt-60 gamma (tritium simulator)	0.2–0.6 tritium beta 0.7–2.9 gamma	1.4–2.0
Zhou et al. [Z6]	Spermatogonial survival	Single injection of HTO and prolonged gamma	Cobalt-60 gamma (tritium simulator)	0.2–0.6 tritium beta 0.7–2.9 gamma	2.1–2.8
Zhou et al. [Z6]	Chromosome aberrations-spermatogonia	Continuous intake of HTO and prolonged gamma	Cobalt-60 gamma (tritium simulator)	0.2–0.6 tritium beta 0.7–2.9 gamma	2.9–3.8
Zhou et al. [Z6]	Primary oocyte survival	Continuous intake of HTO and prolonged gamma	Cobalt-60 gamma (tritium simulator)	0.2–0.6 tritium beta 0.7–2.9 gamma	1.5
Zhou et al. [Z6]	Spermatogonial survival	Continuous intake of HTO and prolonged gamma	Cobalt-60 gamma (tritium simulator)	0.2–0.6 tritium beta 0.7–2.9 gamma	2.3–2.5
Seyama et al. [S13]	Cancer in mice	Single injection of HTO and prolonged gamma	Caesium-137 gamma (tritium simulator)	2.0–10.5 tritium beta and gamma	2.5 <sup>b</sup>

<sup>a</sup> Recalculated value by Little and Lambert [L12].

<sup>b</sup> Calculated at 500 days.



Table 21. In vitro studies using X-rays as reference radiation

<i>Study reference</i>	<i>Biological end point</i>	<i>Exposure conditions</i>	<i>Reference radiation</i>	<i>Dose range (Gy)</i>	<i>RBE values for the tritium beta radiation (95% CI where indicated)</i>
Bocian et al. [B20]	Chromosome aberrations in human lymphocytes	HTO (2 h or 53 h) and acute X-rays	180 kVp X-rays	0.28–2.45 tritium beta 0.5–3.0 X-rays	1.17 (1.13–1.21) 1.91 (0.64, 3.18) <sup>b</sup>
Prosser et al. [P14]	Chromosome aberrations in human lymphocytes	HTO (30 min or 24 h) and acute X-ray	250 kVp X-rays	0.2–4.0 tritium beta 0.1–4.1 X-rays	RBE <sub>M</sub> =1.13 (0.95–1.31)
Vulpis [V3]	Chromosome aberrations in human lymphocytes	HTO (20 min to 2.5 h) and acute X-rays	250 kVp X-rays	0.25–7.0 tritium beta 0.05–9.0 X-rays	2.6 at 0.25 Gy 1.10 at 7 Gy 8.0 (0.2–15.8) <sup>a</sup>
Little [L11]	Transformation in mouse cells	HTO (5–168 h) and acute X-rays	220 kVp X-rays	0.25–5.0 tritium beta 0.5–4.0 X-rays	<1–2 <sup>a</sup>
Kamiguchi et al. [K3, K4]	Chromosome-type aberrations in human sperm	HTO (~80') and acute X-rays	220 kVp X-rays	0.14–2.06 tritium beta 0.25–3.74 tritium beta 0.23–1.82 X-rays	1.08 max dose 1.96 min dose 1.39 (1.26–1.54) <sup>a</sup>
Kamiguchi et al. [K4]	Chromatid-type aberrations in human sperm	HTO (~80') and acute X-rays	220 kVp X-rays	0.14–2.06 tritium beta 0.25–3.74 tritium beta 0.23–1.82 X-rays	1.65 max dose 3.0 min dose 2.17 (1.73–2.73) <sup>a</sup>
Kamiguchi et al. [K4]	Chromosome breakage aberrations in human sperm	HTO (~80') and acute X-rays	220 kVp X-rays	0.14–2.06 tritium beta 0.25–3.74 tritium beta 0.23–1.82 X-ray	1.14 max dose 2.07 min dose 1.47 (1.33–1.62) <sup>a</sup>
Kamiguchi et al. [K4]	Chromosome-exchange aberrations in human sperm	HTO (~80') and acute X-rays	220 kVp X-rays	0.14–2.06 tritium beta 0.25–3.74 tritium beta 0.23–1.82 X-rays	1.54 min dose 2.81 min dose 1.96 (1.49–2.62) <sup>a</sup>

<sup>a</sup> Recalculated by Little and Lambert [L12].

<sup>b</sup> Recalculated by Prosser et al. [P14].

Table 22. In vitro studies using gamma rays (prolonged irradiation) as reference radiation

<i>Study reference</i>	<i>Biological end point</i>	<i>Exposure conditions</i>	<i>Reference radiation</i>	<i>Dose range (Gy)</i>	<i>RBE values for the tritium beta radiation (95% CI where indicated)</i>
Ueno et al. [U1]	Cell survival in mouse cells	HTO (20 h) and prolonged gamma	Cobalt-60 gamma	1.3–8.0 tritium beta 2.0–9.0 gamma	1.5 1.3–1.6 <sup>a</sup>
Ueno et al. [U1]	Micronuclei in mouse cells	HTO (20 h) and prolonged gamma	Cobalt-60 gamma	1.3–8.0 tritium beta 2.0–9.0 gamma	2.0 1.8–2.3 <sup>a</sup>
Ueno et al. [U1]	Mutation induction in mouse cells	HTO (20 h) and prolonged gamma	Cobalt-60 gamma	1.5–4.7 tritium beta 1.5–4.7 gamma	1.8
Yamada et al. [Y1]	Mouse pronuclear embryo cell survival	Prolonged HTO and prolonged gamma	Cobalt-60 gamma	0.009–0.07 Gy/h tritium beta 0.02–0.12 Gy/h gamma <sup>a</sup>	1.09 (0.50–1.68)
Yamada et al. [Y1]	Mouse early 2-cell embryo survival	Prolonged HTO and prolonged gamma	Cobalt-60 gamma	0.009–0.10 Gy/h tritium beta 0.02–0.12 Gy/h gamma <sup>a</sup>	1.70 (1.21–2.20)
Yamada et al. [Y1]	Mouse late 2-cell embryo survival	Prolonged HTO and prolonged gamma	Cobalt-60 gamma	0.009–0.19 Gy/h tritium beta 0.02–0.30 Gy/h gamma <sup>a</sup>	1.25 (0.88–1.62)
Matsuda et al. [M3]	Chromosome aberrations in mouse zygotes	HTO (2 h) and prolonged gamma	Cobalt-60 gamma	0.09–0.34 tritium beta 0.05–0.30 gamma	2.0 1.62 (1.30–2.07) <sup>a</sup>
Tanaka et al. [T7]	Dicentric chromosome aberrations in human lymphocytes	Prolonged HTO and prolonged gamma	Cobalt-60 and Caesium-137 gamma	0.14–2.10 tritium beta 0.05–4.0 gamma	2.1–2.3 2.39 (2.20–2.59) <sup>a</sup>
Tanaka et al. [T7]	Chromosome aberrations in human lymphocytes: centric rings	Prolonged HTO and prolonged gamma	Cobalt-60 and Caesium-137 gamma	0.14–2.10 tritium beta 0.05–4.0 gamma	n.a. 3.14 (2.56–3.86) <sup>a</sup>
Tanaka et al. [T7]	Chromosome aberrations in human lymphocytes: dicentrics and centric rings	Prolonged HTO and prolonged gamma	Cobalt-60 and Caesium-137 gamma	0.14–2.10 tritium beta 0.05–4.0 gamma	2.2–2.7 2.52 (2.33–2.72) <sup>a</sup>
Tanaka et al. [T7]	Chromosome aberrations total in human bone marrow cells	Prolonged HTO and prolonged gamma	Cobalt-60 and Caesium-137 gamma	0.13–1.11 tritium beta 0.25–2.0 gamma	1.13 1.30 (0.96–1.76) <sup>a</sup>
Tanaka et al. [T7]	Chromosome aberrations in human bone marrow cells (chromatids)	Prolonged HTO and prolonged gamma	Cobalt-60 and Caesium-137 gamma	0.13–1.11 tritium beta 0.25–2.0 gamma	3.1 4.96 (3.73–6.59) <sup>a</sup>

<sup>a</sup> Recalculated by Little and Lambert [L12].

281. The RBE values derived from 48 experiments, on mammals in vivo (28) and mammalian cells in vitro (20), is presented in table 23. The RBE values are presented in three study groups: for all studies, for studies of stochastic effects (carcinogenic, genetic, cytogenetic, cell transformations), and for carcinogenic effect in mammals separately; the latter two compared with effects of prolonged exposure to photon radiation (gamma and X-rays). The latter two RBE sets of values are more relevant to effects of low radiation doses on humans. In line with the work of Little and Lambert [L12], the data presented in table 23 are combined mostly from maximum low-dose RBE values (RBE<sub>M</sub> if available).

Table 23. Summary of tritium radiation RBE values from experimental studies using different end points and different reference radiation

Studies	Reference radiation	All studies		Studies of stochastic effects <sup>a</sup> with prolonged reference exposure		Studies of carcinogenic effect in mammals with prolonged reference exposure	
		Number of studies	RBE value (mean/median and range)	Number of studies	RBE value (mean/median and range)	Number of studies	RBE value (mean/median and range)
In vivo	Prolonged gamma	21	2.5 / 2.5 (1.0–3.9)	9	3.0 / 3.0 (1.8–3.9)	1	2.5
	X-rays	7	1.1 / 1.2 (0.4–2.3)	4	1.2 / 1.2 (1.1–1.3)	2	1.3 / 1.3 (1.2–1.3)
In vitro	Prolonged gamma	12	2.1 / 1.8 (1.1–5.0)	8	2.5 / 2.4 (1.3–5.0)	—	—
	Acute X-rays	8	2.4 / 1.7 (1.1–8.0)	—	—	—	—

<sup>a</sup> Including carcinogenic effects.

282. In broad terms, the RBE values from all studies ranged from 1.0 to 5.0 (centred around 2–2.5) and 0.4–8.0 (centred around 1.5–2) with gamma rays and orthovoltage X-rays as reference radiation, respectively. Studies show a general tendency of RBE values to increase with lower doses. There is some tendency for RBE values derived from studies of stochastic effects (centred around 2.5–3 when compared with prolonged gamma radiation) to be generally higher than those obtained from studies of deterministic effects such as cell killing in vivo and in vitro (not presented separately in table 23).

283. Only three of the studies identified have used cancer incidence as an end point [G9, J5, S13]. These studies include accelerated cancer incidence, i.e. cancer occurring at an early age, rather than an increase in the overall incidence of disease, as the end point. The small number of studies and ambiguous end points limit the opportunity to come to a clear conclusion regarding RBE values or their range for the carcinogenic effect of tritium in mammals.

## VIII. EPIDEMIOLOGICAL STUDIES

284. Epidemiological studies of groups of people exposed (or potentially exposed) to tritium fall into two broad categories: those exposed at work and those exposed in the environment. Workplace exposure generally provides a better opportunity for assessing the tritium-specific risks to health following doses received by particular tissues or organs from internally deposited tritium because monitoring for occupational exposure to tritium will usually have been conducted at the facility where exposure occurred (or potentially occurred) and doses may be estimated from these monitoring results. Further, data from monitoring for other sources of occupational exposure to ionizing radiation are likely to be available if assessments for exposure to tritium have been performed at a facility. Such dose monitoring data are required when tritium-specific risk is estimated to distinguish it from other radiation risk sources. Epidemiological studies of tritium workers have generally been unsatisfactory regarding the use of tritium-specific doses monitoring data. Moreover, studies of occupational exposure involve mainly adult men and do not include children who may be more sensitive to tritium-induced adverse health effects.

285. Members of the public are exposed not only to natural sources of tritium, but also to anthropogenic sources such as tritium produced in nuclear weapon explosions, particularly the fallout from the atmospheric thermonuclear weapon tests of the early 1960s. Public exposure to tritium also occurs as a result of releases from nuclear power and nuclear weapon facilities, or from luminizing, radiochemical and other plants, and from devices containing tritium, such as wristwatches with tritium-based luminous paint or emergency exit signs. Studies of environmental exposure to tritium have the advantage that they usually involve exposed (or potentially exposed) individuals other than just adults who are fit enough to be at work. However, a substantial drawback of such environmental studies is that bioassay monitoring for exposure to tritium is unlikely to have been conducted, which greatly reduces the reliability of environmental studies to assess risks specific to tritium exposure. However, there are some instances where such monitoring has been reported for environmental studies.

286. Any analysis of risk in terms of tritium exposure will need to take account of other sources of radiation exposure, such as penetrating radiation from external sources and from intake of other radionuclides, to appropriately distinguish tritium-specific risks from those arising from other sources of radiation exposure. It is important to ensure, if there is a positive correlation between tritium dose and other radiation doses, that any risk from these other radiation doses are taken into consideration.

### A. Studies of occupational exposure

287. Given the variety of sources of exposure to tritium, epidemiological studies of the risks to health from tritium exposure would seem to be attractive, especially in an occupational setting since those workers potentially exposed to tritium are likely to have been monitored for such potential exposure through the analysis of urine samples. The results of this monitoring should have been recorded and, if these records still exist, the data could be made available for scientific use through the production of tritium-specific doses to organs/tissues. Unfortunately, although a number of epidemiological studies of tritium workers have been conducted in various countries, few of these studies have made direct use of tritium monitoring data or have used tritium-specific doses derived from urinalysis data. Studies of exposure to tritium in the workplace are considered below in four broad groupings of studies.

288. All workers at installations with nuclear reactors or reprocessing plants will have been exposed to tritium to some extent because tritium is produced (at a low frequency) in ternary nuclear fission. However, studies of workers exposed to tritium have concentrated on those workers who are likely to have received non-trivial doses from tritium because of certain features of operations at the sites, such as the presence of heavy-water-moderated reactors or tritium production or processing facilities. The epidemiological studies considered in this section focus on studies of workers at such nuclear sites rather than workers exposed to very low levels of tritium because of work at other sites, including light-water-moderated or gas cooled, graphite moderated reactors.

## 1. Studies of workers at installations where tritium is present

289. The weakest of the epidemiological studies of occupational exposure to tritium are those studies that consider workers at sites where exposure to tritium occurs, but make no distinction between workers exposed (or potentially exposed) to tritium and other workers at the site not so exposed. Both the workers monitored for potential exposure to tritium and at least some of the other workers at a site are likely to have been exposed to other sources of radiation.

290. For example, Cragle et al. [C31] studied mortality among almost 10,000 white male workers employed at the Savannah River Site, United States during 1952–1980, and they noted that around 5,000 workers would have been exposed to tritium with 800 of these having received a dose of at least 0.5 mSv from tritium. The workers were found to have standardized mortality ratios (SMRs) that were generally less than 1.0 when compared to the population of the United States (which is probably a reflection of the “healthy worker effect”), but no distinction was made in the analysis between workers monitored for exposure to tritium and other workers. So, although the results of this study are broadly reassuring as far as workers who have been employed at the Savannah River Site, United States are concerned, they are of limited informative value when assessing the risk arising from exposure to tritium, except that the risk of tritium exposure cannot have been grossly underestimated or this would be apparent in the overall results of the study.

291. In another study, McGeoghegan and Binks [M5] examined mortality and cancer incidence among workers at the Capenhurst site in the United Kingdom, a nuclear installation that has handled tritium in relation to nuclear weapon production. This study did not specifically identify those workers monitored for potential exposure to tritium. McGeoghegan and Binks [M5] reported that radiation workers at Capenhurst had a significantly low SMR for all causes of death and a significantly low standardized registration ratio (SRR) for all incident cancer, but workers at this site were exposed to external radiation and to radionuclides other than tritium and it is not possible in this study to disentangle risk posed by tritium from that posed by other sources of radiation. The findings of studies of workforces at establishments where tritium is present to some extent in non-trivial quantities, but which do not distinguish tritium workers from other radiation workers, are summarized in appendix A, table A1.

## 2. Studies of workers monitored for potential exposure to tritium

292. The next set of studies embraces those workers who have been monitored for potential exposure to tritium, but for whom tritium-specific doses are not available or, if available, have not been used. These studies typically identify those workers at an installation who have been monitored for potential exposure to tritium and then calculate SMRs for that particular group. For example, in the study of workers of the United Kingdom Atomic Energy Authority (UKAEA), Beral et al. [B17] identified the subset of workers who had been monitored for potential exposure to tritium and calculated separate SMRs.

293. In some studies, the SMRs for the tritium workers are compared with the SMRs for other workers at the installation to generate rate ratios (RRs), which have the benefit of addressing (at least, to some extent) the healthy worker effect that may be present if the analysis is limited to the calculation of SMRs alone and the reference population is the general population of a country or region. For example, in a follow-up study of UKAEA workers, Fraser et al. [F12] not only calculated SMRs for tritium workers but also compared these SMRs with equivalent SMRs for radiation workers at the UKAEA who had not been monitored for potential exposure to tritium, to generate RRs. However, the absence of tritium-specific doses in these studies means that quantitative tritium-specific risk estimates cannot be generated, although the calculation of SMRs and RRs for tritium workers does permit the identification of possible large effects arising from exposure to tritium, as happened when Beral et al. and Fraser et al. [B17, F12] found significantly raised prostate cancer SMRs and RRs for UKAEA workers who had been monitored for potential exposure to tritium. The findings of this group of studies of workers monitored for potential exposure to tritium are presented in appendix A, table A2.

### 3. Studies of workers using occupational dose estimates

294. Some studies of workplace exposure to tritium have used occupational dose estimates, but have not directly used estimates of tritium-specific doses, if available. Typically, these studies identify workers at an installation who have been monitored for potential exposure to tritium, calculate SMRs and possibly also RRs, and then conduct a dose–response analysis in terms of recorded doses of penetrating radiation from external sources rather than tritium-specific doses. For example, in a nested case-control study of prostate cancer risk among UKAEA workers, Rooney et al. [R14] found that for workers who had been monitored for potential exposure to tritium (or to one of four other radionuclides frequently found in the same workplace environment as tritium), the relative risk of prostate cancer significantly increased with the recorded dose of external radiation, whereas it did not for other workers. For those workers either monitored for potential exposure to tritium or not so monitored but assessed to have the potential for exposure to tritium, the relative risk significantly increased with the assessed level of potential exposure. However, although the significantly increased relative risk was confined to those workers monitored for potential exposure to tritium (rather than those assessed to be potentially exposed, but not monitored) no use was made of the tritium monitoring data to derive tritium-specific doses for analysis [R14]. The absence of tritium-specific doses in this study substantially limits the interpretation of the associations found in terms of tritium-specific risk.

295. Sometimes tritium doses have been derived from monitoring data but are then included with external doses since it is usually argued that tritium produces whole-body doses that are essentially equivalent to (and generally smaller than) doses received from external sources of penetrating gamma rays. For example, in the study of workers of the United Kingdom Atomic Weapons Establishment (AWE), Beral et al. [B18] added the recorded whole-body dose from tritium based upon monitoring data to the recorded whole-body dose from external sources. They found a significantly increasing trend of RR for prostate cancer mortality with increasing whole-body dose (driven by one death with a cumulative external dose >100 mSv), but did not conduct an analysis in which the tritium-specific dose was separated out from the external dose. Any inference concerning a tritium-specific risk obtained from such studies of a positive dose–response for tritium should rely on an assumption of a positive correlation between external doses and tritium doses.

296. Zablotska et al. [Z1] studied mortality in Canadian nuclear industry workers, and added recorded tritium doses derived from urinalysis results to recorded doses from external sources. Again, this did not permit any tritium-specific risk to be identified from the published results because any findings of analyses based on tritium-specific doses were not presented. However, of interest are the results for the

ERR/Sv for leukaemia (excluding CLL) and for all solid cancer, with external doses combined with tritium doses, in comparison with the ERR/Sv estimates using external doses not combined with tritium doses (i.e. for external doses alone): for the combined doses, the ERR/Sv estimates are 18.9 (95% CI: <-2.08, 138) and 2.80 (95% CI: -0.038, 7.13), respectively, and for external dose alone, the ERR/Sv estimates are 16.3 (CI not given) and 2.67 (CI not given), respectively. Therefore, the ERR/Sv estimates show a small increase when the tritium doses are included with external doses but, unfortunately, it is not possible from the published results to derive ERR/Sv estimates for tritium doses alone. The findings of studies that have used records of occupational doses of radiation, but have not used tritium-specific doses for the analysis, are presented in appendix A, table A3.

#### 4. Studies of workers using tritium-specific dose estimates

297. Few studies of workers have tritium-specific dose estimates derived from occupational exposure records and use these doses in a tritium-specific risk analysis. If tritium-specific doses are used in an analysis that appropriately adjusts for any effect of doses received from external sources of radiation (and for any doses received from any other internally deposited radionuclides), these tritium-specific doses should enable estimates to be made of tritium-specific risks, although due account must be taken of the precision of these estimates since the number of workers included in such an analysis may be small, leading to limited statistical power.

298. Zablotska et al. [Z2] conducted a study of Canadian nuclear industry workers and used tritium-specific doses in addition to external doses. However, in most analyses, tritium doses were combined with external doses, so the tritium-specific risk was assessed for only one analysis: the ERR/Sv for all solid cancer was reported as -4.71 (95% CI: <-5.92, 8.58). The wide confidence interval for this estimate is indicative of the limited power of studies of tritium exposure in just one country.

299. Hamra et al. [H4] studied the tritium-specific risk of leukaemia among workers at the SRS and supplemented tritium-specific doses derived directly from occupational monitoring records with annual tritium doses reconstructed from external dose records using tritium monitoring results combined with a job exposure matrix. The authors, in a Bayesian analysis, reported that for leukaemia excluding CLL, the ERR/10 mGy estimate was -0.281 (90% credibility interval: -1.136, 0.548) while if the constraint was imposed that the ERR/10 mGy for the dose from tritium beta particles was greater than that for the dose from penetrating gamma rays, then the ERR/10 mGy estimate became 0.334 (90% credibility interval: 0.049, 0.817). The sensitivity of the results to this constraint and the width of the credibility intervals are notable.

300. Studies of adverse health effects in the offspring of workers exposed to tritium in the preconceptional period, which have made use of tritium monitoring results to calculate tritium-specific doses, have been conducted in Canada [G10, M9] and the United Kingdom [H17, H18]. No association between adverse health effects in offspring and the preconceptional dose derived from tritium monitoring data were found. However, the UK-study illustrated a difficulty in the interpretation of findings based upon the assessed potential for historical exposure to tritium rather than the use of monitoring of dose records. In this regard, a highly significant association between the risk of leukaemia and non-Hodgkin's lymphoma in the offspring of Sellafield workers was assessed to potential for exposure to tritium of fathers in the preconceptional period and was not confirmed by tritium dose monitoring data. This calls into question the reliability of assessed potential for exposure to tritium during historical operations when monitoring of those workers most likely to have received doses resulted in different conclusions. The findings of these studies that have explicitly used tritium-specific doses are summarized in appendix A, table A4.

## B. Studies of environmental exposure

301. The situation is much more uncertain in studies of members of the public potentially exposed to tritium because direct measurements of tritium body burdens in non-occupationally exposed people are rare and not undertaken as part of an epidemiological study. Therefore, any individual assessments of likely environmental exposure to tritium for use in epidemiological studies have to rely upon modelling results, such as estimates of intake and consequent doses to people based upon measurements of tritium in environmental media; but the derived tritium-specific doses are generally very small, leading to extremely low statistical power to detect any tritium-specific effects. Some studies rely only on measures of proximity to a source of tritium, such as a nuclear facility, and this inevitably leads to results that have an uncertain interpretation because the relationship between linear distance from the facility and tritium dose has not been established, and the relationship between distance and level of exposure could be very complex and far from being directly proportional if, say, the wind rose is significantly anisotropic. Further, such studies must take other relevant exposure into account, including other sources of radiation. As a consequence, studies of public exposure to tritium have to be examined carefully and their findings need to be interpreted accordingly.

302. In only one epidemiological study of environmental exposure to tritium has individually assessed exposure to tritium been used, and that is in a historical cohort study of cancer incidence during 1986-2005 among residents of two areas near the Pickering heavy-water-moderated CANDU reactor site in Ontario, Canada [W5]. In this study, exposure to tritium at residences occupied in 1985 was estimated from an atmospheric dispersion model that used discharge and meteorological data, and the exposure data were used in an analysis of cancer risk in relation to tritium exposure. Assessed annual individual effective doses from tritium were very low (maximum for an adult, 2.36  $\mu\text{Sv}$ ), and the limited number of cases of cancer available for study presented problems for some of the analyses, so the lack of detection of an effect of tritium exposure upon cancer risk must be viewed in this light. Nonetheless, this study does illustrate what may be done to address tritium-specific risk in a study of environmental exposure, but it also demonstrates the problems of achieving reasonable statistical power in a practicably sized study of such exposure.

303. With only one epidemiological study of environmental exposure to tritium that takes account of assessed tritium-specific doses to individuals, very little can be reliably inferred from studies of health effects in the vicinities of installations producing, processing or storing tritium. Nuclear installations that include nuclear reactors or reprocessing plants inevitably discharge tritium to some limited extent because, for example, ternary fission product tritium will be produced/processed during the operation at such installations, although such discharges are likely to lead to very small doses. Studies around installations that include heavy-water-moderated reactors or tritium production or processing plants are likely to address higher doses from tritium discharges, although even then tritium-specific doses will, in general, be low; few of these studies have been conducted, and they will be briefly considered in appendix A, table A5.

304. One possibility that can be eliminated by environmental studies is that the risk of childhood leukaemia from exposure to tritium has been grossly underestimated, and that this is the cause of excesses of childhood leukaemia incidence that have been reported around certain nuclear installations, as has been suggested by Fairlie [F1]. Substantial quantities of tritium were released into the environment by atmospheric nuclear weapon testing during the late 1950s and early 1960s, particularly by thermonuclear weapon testing in the early 1960s [U8]. If there has been a serious underestimation of the tritium-specific risk of childhood leukaemia then it would be apparent in the rates of childhood leukaemia incidence following this period of intense nuclear weapon testing, particularly in the Northern Hemisphere where most of the testing took place and tritium-specific doses were highest.



Examination of childhood leukaemia incidence rates from around the world has not revealed any evidence for an increase of childhood leukaemia risk that might be attributed to tritium fallout, or that the risk of childhood leukaemia has been greater in the Northern Hemisphere than in the Southern Hemisphere after this period of intense nuclear weapon testing [W1, W2]. It cannot be claimed that the results of this study show that the risk of childhood leukaemia arising from exposure to fallout from nuclear weapon testing is less than predicted by standard radiation-induced leukaemia risk models (or that there is no risk) because the statistical power is insufficient for this purpose, but the study can exclude a risk that is much greater than predicted, as has been claimed.

## C. Summary of epidemiological studies

305. The great majority of epidemiological studies of tritium workers have not used estimates of tritium-specific doses in their analyses, which limits the inferences that may be made about tritium-specific risk using the findings of these studies. There is no indication, however, from studies of tritium workers that tritium-specific risks have been seriously underestimated. Some results from a few studies that have used tritium-specific doses are available, which represents progress in the epidemiological approach to tritium-specific risks, but the conclusions that may be drawn about tritium-specific risks to health from these few studies are limited.

306. For scientific purposes, it should not be assumed that the effect per unit absorbed dose for tritium is the same as that for an external source of penetrating gamma rays (i.e. the assumption of an RBE value for tritium beta particles of unity), since this question is a component of the epidemiological study. A separate analysis of risk is required using tissue-specific absorbed doses received from tritium rather than equivalent or effective doses. However, tritium-specific absorbed doses to tissues have only rarely been used.

307. Owing to the limited numbers of tritium workers in particular countries, and limited exposure of most of these workers, it is unlikely that epidemiological studies of individual nuclear facilities, or indeed individual countries, will have sufficient statistical power to have a reasonable prospect of detecting the risks predicted by standard models, or of risks not far removed from those predicted. Consequently, international collaboration is required to provide a study large enough to properly investigate tritium risk. Some studies of tritium workers have already been conducted in Canada, the United Kingdom and the United States. Other candidate countries for studies of tritium workers include France and the Russian Federation, and it is possible that other countries, such as China and India, might be able to contribute worker data. It is clear that a coordinated effort is needed if a serious epidemiological evaluation of tritium risk is to be made.

308. It is unlikely that epidemiological studies of environmental exposure to tritium will produce meaningful tritium-specific risk estimates because such exposure is, in general, unlikely to produce tritium-specific tissue/organ doses that are not low or very low. Further, measures of tritium exposure of members of the public based upon monitoring data are rare, and indirect assessments of tritium-specific doses, particularly those based upon linear distance from a point of discharge, are likely to be associated with considerable uncertainty. Those measurements of the presence of tritium in human tissue that have been made do not indicate that assessments of the amounts of tritium entering members of the general public and being retained have been seriously underestimated.

309. The absence of a discernible impact upon global childhood leukaemia incidence rates of tritium released into the environment by atmospheric nuclear weapon testing demonstrates that the risk of childhood leukaemia posed by tritium has not been grossly underestimated, as has been proposed by some commentators.

## IX. RESEARCH NEEDS

### (a) *Heterogeneity, concept of mean dose*

310. The biodistribution of organic forms of tritium is heterogeneous within tissues and cells. The issue of the relevance of the mean organ dose concept as a risk indicator therefore arises. There is no appropriate dosimetric model for use in human risk assessment and radiation protection for tritiated nuclear acid precursors. The development of an appropriate microdosimetric approach to better understand the distribution of dose from various organic forms of tritium within a cell and within tissues and organs is of importance. The uptake and long-term retention of heterogeneously distributed organic forms of tritium in tissue and cells is particularly of concern in assessing doses to germ cells, the embryo, the fetus and the infant. Another physico-chemical form of tritium that is a factor of human, mostly occupational, exposure and deserves further study of biodistribution in body organs and tissues and biokinetics is tritium dust and flakes formed in nuclear fusion reactors on carbon, beryllium or tungsten basis.

### (b) *RBE studies*

311. Up-to-date methods should be used to gather further knowledge on the RBE of tritium beta particles, especially as OBT, focusing not only on aspects relating to carcinogenesis but also on non-cancer effects. In particular, research is required for the various stages of in utero and early childhood exposure. Research aimed at addressing real or practical situations should be prioritized—for instance long-term intake of HTO/OBT as food. Data regarding the potential induction of heritable/transgenerational effects should be critically assessed. New approaches should be investigated, in the light of the latest advances in biology.

### (c) *Mechanistic studies*

312. Mechanistic studies should emphasize cellular damage and notably the types and frequencies of DNA damage caused by tritium beta radiation. Of particular interest is the complexity of DNA damage (that might affect efficiency and fidelity of repair) induced by either DNA synthesis precursors (tritiated thymidine) or tritium-labelled amino acids in chromatin binding proteins, the triggering of (DNA) damage signalling pathways and activation of protective processes (e.g. repair, cell cycle arrest, apoptosis, differentiation) in the context of toxicity, and genome instability. Data are also lacking on the metabolism and biological/mechanistic effects associated with organic tritium (tritiated biochemical substances) in situations of chronic environmental exposure of the public.

### (d) *Environmental considerations*

313. Given the still incomplete knowledge on tritium accumulation and behaviour in sediment, targeted multidisciplinary studies with rigorous protocols need to be used to provide experimental verification of the hypotheses regarding the possible influence of the activity of microorganisms in aquatic sediments when organic tritium is remobilized in aquatic animals. In general, the scientific data regarding the conversion of HTO into organic tritium along the food chain should be enhanced. Reliable quantitative estimates are required.

314. Some information on the levels of tritium in the environment is available, but it would be of value to enhance this database. Measurements in targeted environmental media, including those giving a historical record of exposure, such as tree-rings, particularly in the vicinity of tritium-handling facilities, would be desirable to provide additional confidence in the current understanding of tritium behaviour in the environment and its transfer to food.

315. Some measurements of tritium in humans exposed in the environment are available, from urinalysis and measurements in tissue, for example, at autopsy. It would be desirable to expand this rather sparse database by gathering data from urine sampling programmes, particularly in residents near tritium-handling facilities, and from measurements made on various tissues as the opportunities arise.

### *(e) Epidemiological issues*

316. Epidemiological studies are currently very limited in the robustness of their conclusions due to insufficient statistical power and lack of information on tritium-specific doses. It should be noted that recorded tritium doses for workers in presently available reports are of the order of ten milligray, which implies that very large cohorts would be needed to demonstrate a statistically significant increase in cancer risk at conventionally predicted increases in risk. However, there may be facilities not currently included in epidemiological studies at which workers were exposed to relatively high levels of tritium in the early years of tritium production or processing, and it will be important to include such facilities in any international collaboration. Such studies should use available tritium monitoring data, and exposure information may be improved by dose reconstruction methods, such as the job exposure matrix methodology, which has already been used at one tritium production/processing facility. A coordinated international approach based on standardized dosimetric assessments would be required in order to make progress in this field. Such international collaboration is the only realistic prospect of obtaining tritium-specific risk estimates from occupational epidemiological studies.

317. Since tritium will continue to find large-scale use, especially if commercial fusion reactors come into operation, it would be advisable to seriously consider international collaborative projects to investigate risks posed by tritium to workers that make full use of relevant occupational data, and that these studies should be based on a common protocol for the determination of tritium-specific doses from occupational monitoring data.

318. Unless circumstances can be identified in which relatively large numbers of members of the public have been exposed to relatively high levels of tritium, it is difficult to see how tritium-specific risk estimates can be obtained from epidemiological studies. Should a biomarker of tritium-specific exposure be identified and developed, this could provide opportunities for studies but, even then, the very low exposure from industrial tritium releases would be difficult to distinguish from the background presence of tritium.

319. A more realistic approach to assessing exposure and inferring risks to members of the public is careful monitoring for the presence of tritium in the environment in the vicinity of facilities that discharge tritium, and the possible monitoring of tritium in selected members of the public in these areas through, for example, urinalysis. However, monitoring programmes conducted in areas around facilities handling tritium must also record data on the general levels and variability of tritium away from such facilities in order that results can be appropriately interpreted.

## X. GENERAL CONCLUSIONS

320. Tritium is a radioactive isotope of hydrogen and thus behaves chemically like hydrogen. Humans are exposed internally to beta radiation emitted by tritium either in occupational settings or as members of the public. Workers are generally exposed to higher levels of tritium, as HTO, HT, metal tritides and dust, luminous compounds, tritiated biochemical substrates and some other anthropogenic chemical forms. The general public is exposed to environmental HTO and OBT in food.

321. Absorbed doses arising from the intake of tritium cannot be measured directly and recourse has to be made to the use of biokinetic and dosimetric models such as those of ICRP for dose assessment based on environmental measurements and of bioassay methods (such as the tritium measurement in urine) combined with models for retrospective determination of doses from individual measurements.

322. The ICRP has developed models for estimating the dose from the intake of HTO, or other tritiated compounds that partially convert to HTO after being taken into the body, for inhalation of tritiated gases and low soluble particulate tritium, and for OBT. The current ICRP biokinetic models for tritium intake by workers and members of the public are reasonably consistent with experimental results, and improved models are under development. There is a practical need for the development of biokinetic models for intake of tritiated biochemical substrates, including nucleotropic forms.

323. Doses, and hence risk, from some tritiated biochemical substrates and OBT are greater than those from HTO, due to their longer residence in the body and potentially also as a result of their localization within cells, specifically their proximity to DNA. Direct studies of OBT-related biological effects are not generally feasible because of low tritium concentrations in OBT. However, there are a few studies looking specifically at biological effects related to tritiated biochemical substrates, most of them using DNA precursors and amino acids. There is no appropriate dosimetric model for use in human risk assessment and radiation protection for tritiated DNA precursors. It should be noted, however, that the number of workers dealing with these forms of tritium is rather limited.

324. In laboratory studies of mammals, tritium has been shown to induce both stochastic and deterministic biological effects, consistent with the effects induced by other types of ionizing radiation, and consistent with its generally uniform distribution throughout body tissue, particularly as HTO. The severity of deterministic effects increases with increasing tissue dose above thresholds, as observed with other radiation. Exposure to tritium can also induce stochastic effects, such as cancer or heritable effects, in laboratory mice and rats. However, to date, there is no epidemiological evidence of stochastic health effects being induced by tritium exposure in humans.

325. A review of the RBE studies of tritium beta radiation indicates a range of values from about unity to several-fold higher compared to gamma rays and orthovoltage X-rays depending on many factors such as biological end point, test system, dose and dose rate and choice of reference radiation. RBE values derived from about 50 in vivo and in vitro experiments on mammals, for different end points, ranged from 1.0 to 5.0 (centred around 2–2.5) and from 0.4 to 8.0 (centred around 1.5–2) with regard to gamma rays and orthovoltage X-rays, respectively. Studies also showed a general tendency of RBE values to increase with lower doses. However, the Committee emphasizes that the ability to draw specific conclusions for carcinogenic effect in mammals is limited because of the lack of pertinent data.

326. A number of epidemiological studies have been conducted of workers or members of the public potentially exposed to tritium. Unfortunately, the majority of these studies do not use the results of tritium monitoring to calculate tritium-specific doses for use in the analyses. This makes it very difficult to reliably interpret the findings of these studies in terms of tritium-specific risk as distinct from risk from other types of exposure, principally external sources of penetrating radiation and other internal

emitters. These limitations apply particularly to studies of members of the public, but also extend to studies of tritium workers, because any occupational tritium monitoring data that might be available have not been fully utilized. Consequently, at present, little information of substance on tritium-specific risk can be derived from epidemiological studies of tritium workers or members of the public potentially exposed to tritium beyond the conclusion that tritium-specific risks have not been seriously underestimated.

327. Epidemiological studies of occupational exposure to tritium offer the best prospect of investigating tritium-specific risk to health, but certain requirements have to be fulfilled if this prospect is to be realized. First, tritium-specific doses derived from tritium monitoring and other occupational data need to be calculated from existing records or reconstructed. Second, exposure to other sources of exposure to radiation—such as external sources of penetrating gamma radiation and intake of other radionuclides—needs to be taken into account so that analysis in terms of tritium-specific doses may be adjusted for the presence of other exposure. Third, since the numbers of tritium workers and the tritium-specific doses they receive are limited, international collaboration is required to achieve reasonable statistical power in studying tritium workers to meaningfully investigate tritium-specific risk, and such international collaboration should use a common protocol for the determination of tritium-specific doses. Fourth, the success of an international collaborative study will depend on the numbers of tritium workers available and the doses they have received, so the chance of achieving meaningful results will depend on the participation of as many countries as possible in such a study.

328. As far as the effects of tritium exposure of the public are concerned, there is effectively no information on tritium-specific risk that can be obtained from presently available epidemiological studies. It is unlikely that epidemiological studies of members of the public potentially exposed to tritium will produce results that are interpretable in terms of tritium exposure with any acceptable degree of reliability. This is because environmental tritium exposure is generally very low, and any effect of such exposure against the background of other risk factors will provide a very small signal of tritium risk against this large background noise.

329. Suggestions that reports of excesses of childhood leukaemia incidence near certain nuclear facilities could be due to releases of tritium from these installations because of a serious underestimation of the risk of childhood leukaemia from exposure to tritium are implausible. Large quantities of tritium were released into the environment by atmospheric nuclear weapon testing in the early 1960s and there is no evidence from childhood leukaemia registration rates following exposure to tritium fallout of any major underestimation of the risk of childhood leukaemia from exposure to tritium.

## XI. ACKNOWLEDGEMENTS

The Committee wishes to acknowledge with gratitude the help of the experts, J. Harrison (United Kingdom), B. Lambert (United Kingdom) and R. Wakeford (United Kingdom), who were directly involved in conducting the evaluation, and J. Chen (Canada) for critically reviewing the manuscript. In particular, the Committee would like to thank M. Balonov (consultant) who mainly elaborated this scientific annex based on a first draft prepared by K. Bundy (Canada), D. Chambers (Canada), R. Lane (Canada) and B. Thériault (Canada). The views expressed in the scientific annex remain those of the Committee and do not necessarily represent the views of individual experts, the United Nations or its Member States.



## APPENDIX A: TABLES SUMMARIZING STUDIES OF OCCUPATIONAL AND ENVIRONMENTAL EXPOSURE TO TRITIUM

Tables A1 to A4 present four groups of studies that provide increasing levels of information on tritium-specific risk.

Table A5 presents studies of environmental exposure to tritium released from heavy-water-moderated nuclear reactors or tritium production/processing plants.





Table A1. Studies of workforces that include workers (potentially) exposed to tritium though not explicitly identified

Occupational exposure to tritium at installations with heavy-water-moderated nuclear reactors and/or tritium production/processing plants will generally be greater than exposure at installations where there are very low ambient levels of tritium resulting from, for example, the release of tritium generated in ternary nuclear fission. Consequently, studies of workers exposed to very low levels of tritium at, for example, nuclear power stations with only light-water-moderated reactors are not included in this table

<i>Study references</i>	<i>Summary of study</i>	<i>Summary of findings relating to tritium</i>	<i>Relevance for this report</i>
Cragle et al., and Cragle and Watkins [C31, C32]	Historical cohort study of mortality among white male workers at SRS, USA, first employed 1952–1975. Total 9,860 workers; 1,722 had died before 1987. SMRs, stratified by employee pay code, calculated using general population of US white males as reference. Mortality trends, particularly for various cancers, with recorded external doses. Annual tritium whole-body doses available, but not used. Various subgroups examined, but not tritium workers	About 5,000 workers exposed to tritium, and about 800 workers had recorded dose >0.5 mSv from tritium. SMRs for all causes and all cancers were less than 1.0, which was the case for most causes of mortality, with no SMR significantly above 1.0. Marginally significant positive trend of leukaemia mortality with external dose	Not possible to derive tritium-specific risk, because tritium workers not analysed separately, and tritium-specific doses not used
Richardson et al., and Richardson and Wing [R2, R3, R4]	Historical cohort study of mortality before 2003 (5,098 deaths) among 18,883 workers at SRS before 1987. Cumulative recorded whole-body doses from external exposure combined with tritium-specific doses from urinalysis. Tritium-specific doses alone not used, and workers monitored for potential tritium exposure not considered separately	SMRs significantly <1.0 for all causes and all cancers. Using nested case-control approach, marginally significant positive trend of leukaemia (excluding CLL) mortality with cumulative whole-body dose; strongest for myeloid leukaemia. Adjusting indirectly for smoking, some evidence for positive trend of lung cancer mortality with cumulative whole-body dose	Not possible to derive tritium-specific risk, because tritium workers not analysed separately, and tritium-specific doses not used
McGeoghegan and Binks [M5]	Historical cohort study of mortality (1946–1995) and cancer incidence (1971–1991) among 12,540 workers at Capenhurst, UK. Tritium had been processed before 1988. Annual external whole-body radiation doses were included in the analysis. Unclear how many workers exposed to tritium. Tritium workers not analysed separately and internal doses, such as tritium, were not considered	Most SMRs and SRRs <1.0; several significant association between bladder cancer incidence and cumulative external radiation dose when dose lagged 20 years	Tritium workers not analysed separately and tritium-specific doses not used, so not possible to derive tritium-specific risk
McGeoghegan and Binks [M6]	Historical cohort study of mortality (1955–1995) and cancer incidence (1971–1995) among 2,628 workers at Chapelcross, UK. Tritium production from 1980. Annual external whole-body radiation doses used. Unclear how many workers exposed to tritium. Tritium workers not analysed separately and internal doses not considered	Most SMRs and SRRs <1.0; several significant trends with cumulative external radiation dose found for prostate cancer; no case monitored for tritium and only 2 at Chapelcross after tritium production started	Tritium workers not analysed separately and tritium-specific doses not used, so not possible to derive tritium-specific risk

<i>Study references</i>	<i>Summary of study</i>	<i>Summary of findings relating to tritium</i>	<i>Relevance for this report</i>
McGeoghegan et al., Douglas et al., Omar et al., and Smith and Douglas [D8, M7, O5, S15]	Historical cohort study of mortality (1947–1992) and cancer incidence (1971–1986) among 14,319 workers at Sellafield, UK. Tritium released from reprocessing from 1952, and tritium production during 1955–1962. Doses from external radiation and Pu included in the analyses, but not tritium-specific doses. Tritium workers not identified or analysed separately	SMRs for all causes and all cancers <1.0 for radiation workers. Significant trends of mortality and incidence for leukaemia (excluding CLL) with increasing cumulative external dose	Tritium workers not analysed separately and tritium-specific doses not used, so not possible to derive tritium-specific risk
Carpenter et al. [C7]	Historical cohort study of mortality during 1946–1988 (13,505 deaths) among 75,006 workers at Sellafield, UKAEA and AWE; 40,761 monitored for external radiation (6,900 deaths). Tritium doses at Sellafield, AWE and Harwell generally included with whole-body external dose, but excluded for Winfrith and Dounreay. Tritium workers not considered as a separate group	SMRs for radiation workers and other workers significantly <1.0 for all causes and all cancers. The mortality from leukaemia (excluding CLL) increased significantly with increasing cumulative whole-body dose. No analysis performed for tritium-specific doses and tritium workers not considered as a separate group	Although tritium workers included, not considered separately and tritium-specific doses not analysed alone, so not possible to derive tritium-specific risk
Johnson et al. [J7]	Historical cohort study of mortality before 1997 (6,516 deaths) among 22,543 workers at AWE, UK during 1951–1982. Tritium-specific doses combined with external radiation doses; no analysis of tritium-specific doses alone. Tritium workers not considered separately from other internal dose workers	SMRs for all causes and all cancers significantly <1.0 for all workers, all radiation workers, and all workers monitored for internal emitters. For all internal dose workers, the SMR for kidney cancer was significantly raised. Significant positive trends with cumulative external (plus tritium) dose for mortality from multiple myeloma, bladder cancer and lung cancer (doses lagged 11 years). No mention of prostate cancer [B18]	Neither tritium workers nor tritium-specific doses considered separately, so not possible to derive tritium-specific risk
Muirhead et al. [M22]	Historical cohort study of mortality (26,731 deaths) and cancer incidence (11,165 cases) before 2002 among 174,541 radiation workers included in the UK National Registry for Radiation Workers (NRRW). Analyses for recorded external doses. Internal doses (including tritium) not included; internal dose workers identified and either excluded or presence adjusted for in subsidiary analysis. Tritium workers not identified and not separately analysed	SMRs significantly <1.0 for all causes and all cancers. Significantly raised SMR for pleural cancer. Leukaemia (excluding CLL) and all other cancers significantly increased with increasing external dose. Exclusion of internal dose workers increased slopes for other cancers, but alternatively adjusting for internal monitoring had little impact	Tritium workers included but not analysed separately and tritium-specific doses not used, so not possible to derive tritium-specific risk
Gribbin et al. [G11]	Historical cohort study of cancer mortality during 1956–1985 (227 deaths) among 8,977 male workers employed by Atomic Energy of Canada Limited (AECL) during 1956 to June 1980. Analyses for recorded external doses. Tritium-specific doses not considered. Tritium workers not analysed separately	SMRs significantly <1.0 for all causes and all cancers. Marginally non-significant positive trend of mortality from leukaemia excluding CLL and cumulative external dose	No tritium-specific doses and no separate analysis of tritium workers, so not possible to derive tritium-specific risk

<i>Study references</i>	<i>Summary of study</i>	<i>Summary of findings relating to tritium</i>	<i>Relevance for this report</i>
Sont et al. [S19]	Historical cohort study of cancer incidence during 1969–1988 among 191,333 Canadian workers monitored for exposure to radiation during 1951–1988, using the Canadian National Dose Registry (NDR). Tritium doses estimated from routine urinalysis and added to whole-body external radiation doses. Tritium-specific doses not analysed separately and tritium workers not considered as a separate group	Collective cumulative dose of 1,144.5 man Sv from external gamma radiation compared with that of 122.6 man Sv from tritium. For nuclear workers, mean cumulative tritium dose received from tritium of 5.56 mSv compares with 26.43 mSv received from external exposure; for analysis these two components were combined. SIRs for all cancers significantly <1.0 for males and females. ERR/Sv whole-body dose for all cancers significantly raised	Tritium-specific doses combined with external doses and not considered separately, and tritium workers not considered as a separate group, so not possible to derive tritium-specific risk. Caution needs to be exercised because of problems with the NDR data (see also [Z2])
Metz-Flamant et al. [M11]	Historical cohort study of mortality during 1968–2004 (6,310 deaths) among 59,021 nuclear workers in France during 1950–1994. Analyses of recorded external photon doses. Tritium-specific doses (and other internal doses) not included. Tritium workers not analysed separately	Significant trend with external dose for myeloid leukaemia	Tritium workers not treated as a separate group and tritium-specific doses not used, so not possible to derive tritium-specific risk
Azizova et al., Hunter et al., Moseeva et al., and Sokolnikov et al. [A7, H20, M21, S18]	Historical cohort study of mortality and disease incidence among workers of the Mayak complex in the Russian Federation. Tritium-specific doses not used and tritium workers not considered separately	Study principally concerned with risks from external radiation and from Pu; doses from this exposure were high in the early years of operations at the Mayak complex	Tritium-specific doses not used and tritium workers not identified, so not possible to derive tritium-specific risk
Cardis et al., Fix et al., and IARC [C3, F6, I5]	Historical cohort study of mortality (15,825 deaths), in particular cancer mortality (3,976 deaths), among 95,673 workers at Sellafield, UKAEA and AWE in the UK, Hanford, Rocky Flats and Oak Ridge National Laboratory (ORNL) in the USA, and AECL in Canada (the “IARC 3-country study”). For workers at all sites (except Winfrith and Dounreay) tritium-specific doses included, but combined with recorded external doses. Separate analysis with tritium-specific doses not done and tritium workers not considered separately	ERR/Sv cumulative dose for all cancers excluding leukaemia was 0.07 (90% CI: –0.39, 0.30) while ERR/Sv for all leukaemia excluding CLL was 2.18 (90% CI: 0.13, 5.7)	Neither tritium worker nor tritium-specific doses considered separately so not possible to derive tritium-specific risk

<i>Study references</i>	<i>Summary of study</i>	<i>Summary of findings relating to tritium</i>	<i>Relevance for this report</i>
Cardis et al., Thierry-Chef et al., and Vrijheid et al. [C4, C5, T11, V2]	Historical cohort study of mortality among 407,391 nuclear industry workers from 15 countries (the "IARC 15-country study"). Total of 18,993 deaths included, 5,233 from cancer. Photon doses obtained from records at individual installations. Tritium-specific doses included with whole-body doses, and no separate analysis conducted. Tritium workers not considered separately	Significant association between cumulative (lagged) radiation dose and all-cause mortality (ERR/Sv=0.42), mainly due to a dose-related increase in all cancer mortality (ERR/Sv=0.97). Among 31 specific types of malignancies, significant association for lung cancer (ERR/Sv=1.86) and borderline non-significant associations for multiple myeloma (ERR/Sv=6.15) and ill-defined and secondary cancers (ERR/Sv=1.96). Stratification on duration of employment had a large effect on ERR/Sv estimates, reflecting a strong "healthy worker survivor effect" in the contributing cohorts	No information on tritium-specific doses provided and no separate analysis of tritium workers conducted, so not possible to derive tritium-specific risk. 15-country study has to be treated with caution because of problems with the Canadian worker data (see also [Z2])
Hamra et al., Leuraud et al., Richardson et al., and Thierry-Chef et al. [H5, L9, R5, T12]	Historical cohort study of mortality (66,632 deaths) among 308,297 radiation workers from nuclear installations in USA, UK and France. Doses used derived from recorded external radiation doses. Tritium-specific doses not included in the study (although in some tritium doses included with external doses). Tritium workers not analysed separately	ERR/Gy for all cancers excluding leukaemia 0.39 (90% CI: 0.12, 0.67), all leukaemia excluding CLL 2.96 (90% CI: 1.17, 5.21). Intended that tritium-specific doses excluded from doses used in analysis; seems likely that for some installations and for some years tritium doses included in external dose records	No analysis conducted for tritium-specific doses and tritium workers not considered as a separate group, so not possible to derive tritium-specific risk
Daniels et al., and Schubauer-Berigan et al. [D2, S9, S10]	Nested case-control (1:4 matching) study of leukaemia mortality before 2006 (369 deaths) and radiation exposure among 105,245 workers at six nuclear sites in the USA. 66 (17.9%) cases and 227 (15.4%) controls were exposed to tritium. Internal doses to red bone marrow (RBM) from urinalysis results were included with recorded external photon doses. No separate analysis using tritium-specific doses and tritium workers not treated as a separate group	ERR per 100 mGy (total low-LET radiation dose to RBM) 0.09 (95% CI: -0.17, 0.65) for leukaemia excluding CLL (ERR per 100 mGy for exposure 6–14 years prior to diagnosis 1.9 (95% CI: <0, 8.0)). Tritium-specific doses to RBM available (mean 0.2 mGy; maximum, 85.1 mGy) but not used alone	Tritium-specific doses alone not used, and tritium workers were not considered as a separate group, so not possible to derive tritium-specific risk

Table A2. Studies of workers monitored for (potential) exposure to tritium, identified and investigated as such, but tritium-specific doses not available or not used

<i>Study reference</i>	<i>Summary of study</i>	<i>Summary of findings relating to tritium</i>	<i>Relevance for this report</i>
Beral et al. [B17]	Historical cohort study of mortality (3,373 deaths during 1946–1979) in 39,546 workers at UKAEA. Exposure to tritium occurred at UKAEA sites. Of 20,382 workers exposed to external radiation, 1,418 also potentially exposed to tritium, and tritium workers were considered separately. Only doses from external radiation used, not tritium doses (apart from Harwell from 1977 when tritium included in whole-body exposure)	Tritium doses not quantified. All causes SMR for tritium workers significantly low at 0.59, and all cancers SMR non-significantly low at 0.77. On the basis of 6 deaths, prostate cancer SMR significantly raised, at 8.89; all 6 deaths with cumulative external doses $\geq 50$ mSv (SMR=12.77)	Absence of tritium-specific doses does not permit a reliable conclusion on the potential role of tritium in the raised prostate cancer SMR for the group of tritium workers
Carpenter et al. [C8]	Historical cohort study of mortality (4,149 deaths) during 1946–1988 among 40,761 external radiation workers at Sellafield, UKAEA and AWE. 4,111 workers monitored for tritium analysed separately, but tritium-specific doses not used, only a flag indicating tritium monitoring	For tritium workers, SMRs for all causes and all cancers significantly $< 1.0$ , and compatible with other radiation workers. SMR and RR for prostate cancer non-significantly raised; testicular cancer the only cancer with significantly elevated RR buccal cavity and pharynx the only cancer with significantly reduced RR. Little evidence that RRs varied with period since, or age at, or calendar year of first monitoring or with age at first monitoring. For UKAEA or AWE workers, data available on duration of monitoring; among tritium-monitored workers, for prostate cancer, significant variation with number of years monitored (highest in workers monitored in 2–4 years). Significantly raised RR for lung cancer among tritium workers with external dose $< 10$ mSv, but not $\geq 10$ mSv. Non-significantly raised RR (=1.39) for prostate cancer among tritium workers with external doses $\geq 10$ mSv	Absence of tritium-specific doses does not permit a reliable conclusion about tritium-specific risk

<i>Study reference</i>	<i>Summary of study</i>	<i>Summary of findings relating to tritium</i>	<i>Relevance for this report</i>
Gillies and Haylock, and McGeoghegan et al. [G4, M8]	Historical cohort study of mortality (19,613 deaths) and cancer incidence (10,411 cases) before 2006 among 64,956 workers employed during 1946–2002 by British Nuclear Fuels plc (BNFL) at Sellafield, Springfields, Capenhurst and Chapelcross. 42,431 external radiation workers, and 22,675 workers also monitored for tritium, Pu and U. 1,757 workers were monitored for tritium, 1,062 for tritium only. Analyses with external doses only, not internal doses (including tritium), but workers flagged for tritium monitoring. In some analyses, tritium workers considered separately	SMRs for all causes and all cancers significantly <1.0 for both radiation and non-radiation workers, but RRs <1.0, significantly for all causes of death. All causes and all cancers RRs for internal radiation workers vs. other radiation workers did not differ significantly from 1.0. Mortality from both cancer and non-cancer increased significantly with increasing cumulative external dose; for cancer trend significantly less for internal radiation workers than external only radiation workers, and same pattern for cancer incidence. For tritium workers, SMR for all causes significantly <1.0, but SMR for all cancers non-significantly >1.0 (contrasting with SMR of 1.0 for Pu workers and SMR significantly <1.0 for U workers). Tritium worker SMRs significantly >1.0 for pleural and female breast cancer. RR comparing all cancer SMR for tritium workers vs. external only radiation workers significantly >1.0. Mortality RR for female breast cancer significantly >1.0 (2 deaths among tritium workers) and also for all smoking-related cancer. All cancer SIR for tritium workers non-significantly >1.0 (and non-significantly greater than SIRs for Pu and U workers). SIRs for pleural, testicular and non-melanoma skin cancer significantly >1.0. Incidence RR for all cancers significantly >1.0 for tritium workers vs. external only radiation workers, and incidence RR significantly raised for non-smoking-related solid cancer and for solid cancer excluding lung, liver and bone. Tritium workers stated to have significantly increasing incidence of digestive cancer with increasing cumulative external dose	Tritium workers considered separately, and all cancer risk (both mortality and incidence) significantly greater vs. external only radiation workers. However, tritium-specific doses not used so not possible to draw reliable conclusions about tritium-specific risk
Boice et al. [B22]	Historical cohort study of mortality during 1944–2009 (3,681 deaths) among 7,270 workers at the Mound nuclear facility, USA, during 1944–1979. 4,509 workers monitored for external radiation. Tritium processed at Mound during 1954–1997; 4,134 workers monitored for tritium (1,125 with positive urinalysis result). Tritium doses estimated on assumption that intake was HTO, and added to the doses from other sources. Tritium-specific doses alone not used in analysis	Mean tritium dose for workers with positive monitoring result 8 mSv and maximum 195.5 mSv. (Mean external dose 26 mSv and maximum 939.1 mSv.) For workers with non-zero tritium dose, SMRs for all causes and all cancers significantly <1.0. For specific cancers, SMRs were generally <1.0, including prostate cancer and (significantly) lung cancer. For dose-response analysis, with tritium doses included in total organ/tissue doses, significant positive trend for oesophageal cancer and negative trend for liver cancer	Tritium workers did not have unusual patterns of mortality. Tritium-specific doses incorporated into total organ/tissue doses in analysis, so that tritium-specific risk cannot be derived

Table A3. Studies of workers monitored for (potential) exposure to tritium, identified and investigated as tritium workers, and occupational dose records used, but tritium-specific doses not available or not explicitly used

<i>Study reference</i>	<i>Summary of study</i>	<i>Summary of findings relating to tritium</i>	<i>Relevance for this report</i>
Beral et al. [B18]	Historical cohort study of mortality during 1951–1982 (3,115 deaths) among 22,552 workers at AWE, UK, before 1983. 9,389 workers monitored for external radiation; 1,562 also monitored for tritium. Whole-body doses from tritium added to recorded external doses. Tritium workers considered as a separate group for some analyses, but tritium-specific doses not used	<2% of workers had a tritium dose >10 mSv. SMRs for tritium workers vs. other radiation workers not unusual: RRs of 1.02 for all cancers and 0.97 for other causes (did not vary notably with different dose-lagging periods). Tritium workers had a significant trend of prostate cancer with cumulative whole-body dose compared with workers not monitored for tritium exposure (on the basis of 3 deaths; trend driven by 1 death with cumulative whole-body dose ≥100 mSv). For tritium workers, SMR for prostate cancer non-significantly elevated at 2.50 with RR 1.27 vs other radiation workers	Very few prostate cancer deaths for tritium workers, and no analysis with tritium-specific doses alone, so reliable conclusions cannot be drawn about tritium-specific risk
Fraser et al. [F12]	Historical cohort study of mortality during 1946–1986 (5,509 deaths) and cancer morbidity during 1971–1984 (1,594 cases) in 39,718 UKAEA workers, including 1,702 workers monitored for tritium, considered separately. Only recorded external doses used (except tritium doses at Harwell from 1977 included in whole-body doses)	SMRs for tritium workers compared with SMRs for other radiation workers significantly raised RR only for prostate cancer, with SMR in tritium workers 2.82 (7 deaths) (see also [B17]). Significant association of prostate cancer mortality with cumulative external radiation dose for tritium workers – all 7 deaths with cumulative external doses ≥100 mSv (SMR 5.31). High case fatality for most cancer led to cancer morbidity results similar to mortality	Tritium-specific doses not quantified, so no reliable conclusion on tritium-specific risk of prostate cancer (or other cancer) can be reached. Cannot assume that external dose gives an acceptable measure of tritium dose
Rooney et al. [R14]	Nested case–control study (1:3 matching) of 136 UKAEA workers diagnosed with prostate cancer between 1946 and 1986, and 404 matched controls. 65% of study subjects had been monitored for external radiation (a matching criterion). Monitored and assessed exposure to tritium (and a number of other radionuclides) included in analysis. Although assessed level of tritium exposure used in some analyses, tritium-specific doses derived from monitoring data were not used	Risk of prostate cancer significantly increased in men monitored for tritium, with RR 14.26 (95% CI: 3.09, 133.16). Significantly raised RR for men working >10 years with heavy-water-moderated reactors. Significant trend of RR with increasing external dose for those men likely to have been exposed to tritium or one of four other radionuclides (Cr-51, Fe-59, Co-60 or Zn-65). Assessed potential for tritium exposure, and likely level of exposure, gave significant trend of risk with assessed degree of exposure. When only men assessed as potentially tritium exposed, but not monitored for exposure, included in analysis, no significant increase in prostate cancer RR. Owing to multiple, not possible to disentangle the independent effects of tritium, Cr-51, Fe-59, Co-60 and Zn-65	Exposure to tritium could not be separated from exposure to four other radionuclides. Absence of tritium-specific doses prevents a reliable estimate of the tritium-specific risk of prostate cancer

<i>Study reference</i>	<i>Summary of study</i>	<i>Summary of findings relating to tritium</i>	<i>Relevance for this report</i>
Atkinson et al. [A5, A6]	Historical cohort study of mortality before 1998 (10,249 deaths) among 51,367 UKAEA workers before April 1996; 26,395 monitored for external radiation. Some tritium-specific doses included with recorded external doses, although not for Dounreay and Winfrith. Tritium workers considered separately in some analyses. Tritium-specific doses not used	SMRs for all causes and all cancers for non-radiation workers, radiation workers and internal dose workers all significantly <1.0. For tritium workers, no SMR significantly raised, but prostate cancer SMR for tritium workers significantly higher than for other radiation workers. Previously reported significant positive trend of prostate cancer risk with cumulative external dose for tritium workers [F12]. No longer significant and no trend with external dose for 1980–1997	Absence of tritium-specific doses, so little can be derived about tritium-specific risk
Ashmore et al. [A4]	Historical cohort study of mortality during 1951–1987 (5,426 deaths) among 206,620 Canadian radiation workers during 1951–1983, using Canadian NDR. Tritium doses from urinalysis added to whole-body external radiation doses. Tritium-specific doses and tritium workers not considered separately	For all causes of death, when tritium doses included with whole-body external doses, ERR per 10 mSv, 2.6 (90% CI: 1.6, 3.6), with tritium doses excluded (i.e. external doses only) and, ERR per 10 mSv, 2.5 (90% CI: 1.5, 3.5). Risk estimates for tritium doses alone not given. The group of workers monitored for potential exposure to tritium not considered separately	ERR/Sv for all causes of death did not change substantially when tritium doses included with external doses. Separate results for tritium-specific doses alone not presented, so little can be concluded about tritium-specific risk. Caution needs to be exercised because of problems with the NDR data used (see [Z2])
Zablotska et al. [Z1]	Historical cohort study of mortality during 1957–1994 (1,599 deaths) among 45,468 Canadian nuclear industry workers (from AECL, Ontario Hydro, Hydro Québec and New Brunswick Power) during 1957–1994, using Canadian NDR tritium doses from urinalysis and added to recorded external radiation doses. Tritium-specific doses and tritium workers not considered separately	Mean cumulative dose 13.5 mSv; among workers with non-zero doses, mean 19.7 mSv. SMRs for all causes of death and all deaths from cancer significantly <1.0. ERR/Sv total cumulative dose marginally non-significantly positive for all solid cancers combined and marginally significantly positive for all leukaemia excluding CLL; ERR/Sv show small increases (from 2.67 to 2.80, and from 16.3 to 18.9, respectively) when tritium doses included with external doses	ERR/Sv for all solid cancers and all leukaemia did not materially change when tritium doses excluded from whole-body doses, but tritium-specific doses alone not used, so not possible to draw reliable conclusions about tritium-specific risk. Caution needs to be exercised because of problems with the NDR data used (see also [Z2])
Schubauer-Berigan et al. [S11]	Historical cohort study of mortality (41,508 deaths) among 119,195 radiation workers at five nuclear sites in the USA. Tritium-specific doses from urinalysis added to recorded external doses but separate analysis with tritium-specific doses alone not done – separate analysis for all cancers and all haematopoietic and lymphatic cancers with both neutron and tritium doses excluded from cumulative doses. Tritium workers not considered separately	SMRs for all causes and all cancers significantly <1.0. ERR per 10 mSv whole-body dose 0.14% (95% CI: –0.17%, 0.48%) for all cancers combined and 2.0% (95% CI: 0.71%, 3.5%) for all haematopoietic and lymphatic cancer. When neutron and tritium doses together excluded from the whole-body dose, ERR per 10 mSv became 0.18% (95% CI: –0.14%, 0.53%) and 2.0% (95% CI: 0.73%, 3.7%), respectively	Absence of tritium-specific doses alone, and tritium workers considered separately, so little can be derived about tritium-specific risk



Table A4. Studies of workers monitored for (potential) exposure to tritium, identified and investigated as tritium workers, and tritium-specific doses available and used in analyses so that tritium-specific risk may be examined explicitly

<i>Study reference</i>	<i>Summary of study</i>	<i>Summary of findings relating to tritium</i>	<i>Relevance for this report</i>
Hazelton et al. [H8]	Historical cohort study using a biologically-based analysis of lung cancer incidence during 1969–1988 (400 cases, 322 in men) among 191,042 Canadian radiation workers during 1951–1988, making use of Canadian NDR. Tritium-specific doses used in analysis, mainly in combination with whole-body gamma-ray doses	Of collective dose from external gamma radiation and tritium combined, tritium contributes 9.0%. 95,430 males, 60,677 with non-zero doses (mean cumulative gamma plus tritium dose, 18.2 mSv), 9,013 with non-zero tritium doses (2 253 with tritium doses >14.95 mSv). Significant dose–response for men with gamma-ray and tritium doses combined, and with gamma-ray doses alone, but for tritium doses alone dose–response only marginally significant. Allowing RBE for the tritium absorbed dose to vary did not improve fit significantly. When dataset restricted to 69,826 men not flagged for neutron exposure, dose–response for tritium doses alone not significant. For 95,603 women (44,238 with non-zero radiation doses, mean cumulative gamma plus tritium dose 3.8 mSv), dose–response non-significant, but consistent with dose–response for men. For men, modelling predicts ~31 cases attributable to gamma radiation and ~2 cases to tritium exposure	Analyses performed with tritium-specific doses alone, although most results for gamma and tritium doses combined. Modelling predicts ~2 lung cancer cases attributable to tritium exposure. Caution needs to be exercised because of problems with the NDR data used (see [Z2])
Zablotska et al. [Z2]	Review by Canadian Nuclear Safety Commission of employment and dose records for Canadian nuclear workers led to corrections and improvements to records. Mortality (489 cancer deaths during 1956–1994) in revised historical cohort of 45,468 nuclear workers (originally studied by [Z1]) reanalysed. Particular attention paid to accuracy of records for AECL workers before 1965. Tritium doses from urinalysis. Summary doses for whole-body external (gamma) and internal (mainly tritium) radiation used for risk analysis. Workers with neutron or high internal exposure excluded. Tritium workers not considered separately	42,228 workers first monitored since 1965 had no significant ERR/Sv for solid cancer (-1.20) or leukaemia (14.4, p=0.28). This contrasted significantly with ERR/Sv for solid cancer in 3,088 AECL workers first monitored during 1956–1964: ERR/Sv=7.87 (p <0.01) (but no dose-related risk of leukaemia). Very likely that dose information in Canadian NDR incomplete for early AECL workers. Mean cumulative tritium dose in revised cohort 3.02 mSv, 14% of mean cumulative total dose; 809 workers had tritium doses >50 mSv. When in revised cohort tritium doses added to risk model for solid cancer with gamma doses as second linear term, fit of model did not improve; in model with two separate dose terms, for gamma component ERR/Sv was 2.56 (95% CI: -0.11, 6.79), while for tritium component ERR/Sv was -4.71 (95% CI: <-5.92, 8.58). For individual cancer types, adding tritium doses to risk model did not improve fit, and risk due solely to gamma doses	Analysis of mortality from all solid cancers, individual solid cancers and leukaemia showed risk due solely to whole-body gamma doses and that the addition of tritium doses did not improve fit of the model. Study provides estimates of tritium-specific risk, but uncertainties associated with estimates are large due to generally low tritium doses received by a limited number of workers

<i>Study reference</i>	<i>Summary of study</i>	<i>Summary of findings relating to tritium</i>	<i>Relevance for this report</i>
Hamra et al. [H3, H4]	Reconstruction of tritium-specific annual doses for workers at SRS, USA, using tritium urinalysis data, recorded external doses, and a job-exposure matrix approach [H3]. Reconstructed tritium-specific doses used in a study of tritium-specific leukaemia risk [H4], using Bayesian approach informed by experimental studies of tritium	From 75,523 dose records for 1954–1978 the proportion of the whole-body dose from tritium was calculated for various jobs, areas and time periods, and tritium doses assigned for 43,590 person-years. Under a strong assumption that the leukaemia risk per 10 mGy from tritium is always greater than that from external gamma radiation, authors derived ERR per 10 mGy of 0.298 (90% credibility interval: 0.027, 0.702) for leukaemia and 0.344 (90% credibility interval: 0.049, 0.817) for leukaemia excluding CLL. Risks obtained without the restriction that the leukaemogenic effect of tritium is always greater than that of external gamma radiation leads to values of 0.141 (90% credibility interval: –0.323, 0.649) and –0.281 (90% credibility interval: –1.136, 0.548), respectively	Illustrates what may be done using occupational records to derive tritium-specific doses for use in epidemiological analysis. Tritium-specific leukaemia risk is uncertain because of limited data, and the dependence of leukaemia ERR/Sv upon the strong assumption that the risk per unit absorbed dose from tritium is always greater than that for gamma radiation means that the findings must be treated with caution
HSE [H17, H18]	Case-control study investigating exposure of fathers working at Sellafield before the conception of their children and an increased risk of leukaemia and non-Hodgkin's lymphoma (LNHL) in these children. Exposure considered included tritium, both assessed potential for exposure and doses derived from contemporary tritium monitoring data	Highly significant association between risk of LNHL in offspring and assessed potential for paternal exposure to tritium in preconceptional period. Association not reproduced when doses derived from measured exposure to tritium based on contemporary monitoring data used	Paternal preconceptional tritium doses derived from monitoring data do not indicate raised risk of LNHL in offspring. Risk indicated by assessed potential for tritium exposure must be treated with caution given difficulties of retrospective assessment of potential for historical tritium exposure
McLaughlin et al. [M9]	Matched case-control study (1:8 matching) of childhood leukaemia (112 cases during 1950–1988) and paternal preconceptional exposure of workers in Ontario, Canada. Analyses included external and tritium doses from occupational records	No association between childhood leukaemia risk and paternal preconceptional radiation dose found for either recorded external whole-body dose or tritium dose. For tritium exposure, no father of an affected child was recorded as exposed while 14 control fathers had preconceptional exposure	No indication of measured paternal preconceptional tritium exposure increasing the risk of childhood leukaemia in offspring
Green et al. [G10]	Matched case-control study (1:1 matching) of congenital anomalies in offspring of workers of Ontario Hydro. Preconceptional tritium doses based on monitoring data	No association between risk of congenital anomalies and the tritium dose received during the preconceptional period	Tritium doses received prior to conception did not increase the risk of congenital anomalies in the child

Table A5. Studies of environmental exposure to tritium released from heavy-water-moderated nuclear reactors or tritium production/processing plants

<i>Study reference</i>	<i>Summary of study</i>	<i>Summary of findings related to tritium</i>	<i>Relevance for this report</i>
Wanigaratne et al. [W5]	Historical cohort study of cancer incidence 1986–2005 using data from the Ontario Cancer Registry, among people living near Pickering heavy water CANDU nuclear reactor site in Ontario in 1985 and in comparison area (north Oshawa) further from site. Atmospheric tritium concentrations estimated for each 1985 residential location using atmospheric dispersion model with tritium discharge and meteorological data. Model predictions compared with monitoring results. In addition to all cancers combined, leukaemia and cancer of the lung, thyroid, female breast and of childhood examined	More than half of Pickering and all north Oshawa residents experienced modelled average tritium concentration levels <2.9 Bq/m <sup>3</sup> , representing annual effective dose of 0.47 µSv for average adult. The all cancer SRR significantly less than 1.0 for both cohorts. Effect of emigration from Ontario not assessable. Only for female childhood cancer in Pickering, SRR significantly raised. For Pickering residents living at the same address in 1985 as in 1979 (“non-movers”), assessed tritium exposure not associated with risk of lung cancer or female breast cancer (other cancer case numbers too small for this analysis)	This study used assessed tritium-specific exposure residents at the same address for at least six years for analysis of cancer incidence. However, doses based on residential histories not reconstructed. Tritium-specific dose estimates very small (maximum annual effective dose, 2.36 µSv), and number of cancer cases (available for just one installation) limited, so power of study to detect any risk was low. Nonetheless, study attempts to address tritium-specific cancer risk, not done in any other environmental exposure study
Grosche et al. [G13]	Comparison of childhood leukaemia incidence around Krümmel nuclear power station, Germany and SRS, USA. Study conducted because of suggestion that tritium discharges from Krümmel (a boiling (light) water reactor) responsible for marked excess of childhood leukaemia cases in the vicinity of the site. In contrast, SRS produced/processed relatively large quantities of tritium for weapons	If releases of tritium from Krümmel site responsible for excess childhood leukaemia cases in immediate vicinity, then the much larger releases from SRS would detectably increase childhood leukaemia risk in neighbourhood. Around SRS, however, statistically non-significant deficit of childhood leukaemia incidence found. Therefore, theory of childhood leukaemia excess around Krümmel due to tritium exposure not supported by this study	Absence of human monitoring data and assessed tritium-specific doses from this study limits possible conclusions on tritium-specific risk. Nonetheless, absence of a detectable increased risk of childhood leukaemia around SRS does not support serious underestimation of the tritium-specific risk of childhood leukaemia
Cragle et al., Cragle and Watkins, and McLaughlin et al. [C31, C32, M9]	Geographical study of childhood leukaemia incidence (1964–1986) and mortality (1950–1987) within 25 km of nuclear installations in Ontario, Canada, in particular, the heavy-water-moderated CANDU reactor power stations	For children born within 25 km of the nuclear power stations, (marginally) non-significant excess of childhood leukaemia mortality and a non-significant excess of childhood leukaemia incidence. Non-significant excess of childhood leukaemia mortality among those resident within 25 km of the nuclear power stations	In the absence of assessed tritium-specific doses to individuals, little may be concluded from this study about the tritium-specific risk of childhood leukaemia
Johnson and Rouleau [J6]	Geographical study of birth abnormalities, perinatal and infant mortality during 1971–1988 within 25 km of Pickering heavy-water-moderated CANDU reactor site in Ontario, Canada. Health outcome data analysed for airborne and waterborne tritium emissions from the site, and using ground-monitored airborne tritium concentration data	No unusually high mortality or abnormality rates found in study area. Only association between tritium release levels and birth abnormalities was for CNS abnormalities, but not reproduced using ground monitoring data. Although some evidence of elevated risk of Down’s syndrome around Pickering, no consistent associations with tritium release levels and ground monitoring data found	Lack of assessed individual exposure to, or doses from, tritium means no substantial conclusions on tritium-specific risk may be drawn from this study

<i>Study reference</i>	<i>Summary of study</i>	<i>Summary of findings related to tritium</i>	<i>Relevance for this report</i>
Richter and Stockwell [R10]	Cancer mortality (during 1980–1991) among residents of Lamar County, Mississippi, near the Salmon (underground) nuclear test site, following two nuclear tests in 1964 and 1966. Residents worried that tritium released due to these two explosions detectably increased cancer risk in vicinity	No increase in environmental tritium levels as a result of the nuclear tests detected. Observed cancer mortality rates for Lamar County no different from those expected for all Mississippi. No association between cancer mortality rate and distance from detonations	Lacking measured increases of exposure to tritium resulting from the nuclear tests, this study provides no information on tritium-specific risk. Conducted as a public reassurance exercise

## REFERENCE

- A1 Alloni, D., C. Cutaia, L. Mariotti et al. Modeling dose deposition and DNA damage due to low-energy beta (-) emitters. *Radiat Res* 182(3): 322-330 (2014).
- A2 Alvarez, L.W. and R. Cornog. Helium and hydrogen of mass 3. *Phys Rev* 56(6): 613 (1939).
- A3 Amano, H., M. Atarashi, H. Noguchi et al. Formation of organically bound tritium in plants during the 1994 chronic HT release experiment at Chalk River. *Fusion Sci Technol* 28(3P1): 803-808 (1995).
- A4 Ashmore, J.P., D. Krewski, J.M. Zielinski et al. First analysis of mortality and occupational radiation exposure based on the National Dose Registry of Canada. *Am J Epidemiol* 148(6): 564-574 (1998).
- A5 Atkinson, W.D., D.V. Law, K.J. Bromley et al. Mortality of employees of the United Kingdom Atomic Energy Authority, 1946-97. *Occup Environ Med* 61(7): 577-585 (2004).
- A6 Atkinson, W.D., D.V. Law and K.J. Bromley. A decline in mortality from prostate cancer in the UK Atomic Energy Authority workforce. *J Radiol Prot* 27(4): 437-445 (2007).
- A7 Azizova, T.V., E.S. Grigorieva, N. Hunter et al. Risk of mortality from circulatory diseases in Mayak workers cohort following occupational radiation exposure. *J Radiol Prot* 35(3): 517-538 (2015).
- B1 Bacchetta, A. Analyse et speciation du tritium dans des matrices environnementales. Thesis, Universite Pierre et Marie Curie, Paris VI (2014). (French).
- B2 Baglan, N., S.B. Kim, C. Cossonnet et al. Organically bound tritium (OBT) behaviour and analysis: outcomes of the seminar held in Balaruc-les-Bains in May 2012. *Radioprotection* 48(1): 127-144 (2013).
- B3 Baker, T.G. Comparative aspects of the effects of radiation during oogenesis. *Mutat Res* 11(1): 9-22 (1971).
- B4 Baker, T.G. and A. McLaren. The effect of tritiated thymidine on the developing oocytes of mice. *J Reprod Fertil* 34(1): 121-130 (1973).
- B5 Baker, T.G. and P. Neal. Action of ionizing radiation on the mammalian ovary. in: *The Ovary. Volume III: Regulation of Oogenesis and Steroidogenesis* (L. Zuckerman and B.J. Weir, eds.). Academic Press, Inc., New York, 1977.
- B6 Balonov, M. and L. Chipiga. Dose assessment for intake of tritiated water in humans: role of tritium incorporation in organic matter. *Radiat Hyg* 9(4): 1-8 (2016). (Russian).
- B7 Balonov, M.I., E.I. Dolgirev and I.A. Likhtarev. Exchange kinetics and dosimetry of tritium oxide in man for different routes of administration. *Health Phys* 27(4): 367-375 (1974).
- B8 Balonov, M.I. Tritium dosimetry and standardization [Dozimetriya i normirovanie tritiya]. *Ehnergoatomizdat* 16: 152 (1983). (Russian).
- B9 Balonov, M.I. and O. Kudritskaia. Mutagenic action of tritium on the germ cells of male mice. I. The induction of dominant lethal mutations by tritium oxide and an assessment of its relative biological effectiveness. *Genetika* 20(2): 224-232 (1984). (Russian).
- B10 Balonov, M.I., O. Kudritskaia and G. Bruk. Relative biological effectiveness of tritium oxide by the criterion of death of the germ cells in mice. *Radiobiologiya* 24(1): 114-117 (1984). (Russian).
- B11 Balonov, M.I., I.A. Likhtarev and Y. Moskalev. The metabolism of <sup>3</sup>H compounds and limits for intakes by workers. *Health Phys* 47(5): 761-773 (1984).

- B12 Balonov, M.I., K.N. Muksinova and G.S. Mushkacheva. Tritium radiobiological effects in mammals: review of experiments of the last decade in Russia. *Health Phys* 65(6): 713-726 (1993).
- B13 Baumgartner, F. and W. Donhaerl. Non-exchangeable organically bound tritium (OBT): its real nature. *Anal Bioanal Chem* 379(2): 204-209 (2004).
- B14 Belloni, P., G.F. Clemente, S. di Pietro et al. Tritium levels in blood and urine samples of the members of the Italian general population and some exposed subjects. *Radiat Prot Dosim* 4(2): 109-113 (1983).
- B15 Bennett, B.G. Environmental tritium and the dose to man. Proceedings of the Third International Congress of IRPA. IRPA, Washington D.C., 1973.
- B16 Bennett, B.G. Worldwide dispersion and deposition of radionuclides produced in atmospheric tests. *Health Phys* 82(5): 644-655 (2002).
- B17 Beral, V., H. Inskip, P. Fraser et al. Mortality of employees of the United Kingdom Atomic Energy Authority, 1946-1979. *Br Med J (Clin Res Ed)* 291(6493): 440-447 (1985).
- B18 Beral, V., P. Fraser, L. Carpenter et al. Mortality of employees of the Atomic Weapons Establishment, 1951-82. *Br Med J* 297(6651): 757-770 (1988).
- B19 Bigildeev, E.A., V. Michalik and L. Wilhelmova. Theoretical estimation of quality factor for tritium. *Health Phys* 63(4): 462-463 (1992).
- B20 Bocian, E., B. Ziemb-Zak, O. Rosiek et al. Chromosome aberrations in human lymphocytes exposed to tritiated water in vitro. *Curr Top Radiat Res Q* 12(1-4): 168-181 (1978).
- B21 Bogen, D.C. and G.A. Welford. "Fallout tritium" distribution in the environment. *Health Phys* 30(2): 203-208 (1976).
- B22 Boice, J.D., Jr., S.S. Cohen, M.T. Mumma et al. Mortality among mound workers exposed to polonium-210 and other sources of radiation, 1944-1979. *Radiat Res* 181(2): 208-228 (2014).
- B23 Bond, V.P., C.B. Meinhold and H.H. Rossi. Low-dose RBE and Q for x-ray compared to gamma-ray radiations. *Health Phys* 34(5): 433-438 (1978).
- B24 Botchway, S.W., D.L. Stevens, M.A. Hill et al. Induction and rejoining of DNA double-strand breaks in Chinese hamster V79-4 cells irradiated with characteristic aluminum K and copper L ultrasoft X rays. *Radiat Res* 148(4): 317-324 (1997).
- B25 Bouville, A., S.L. Simon, C.W. Miller et al. Estimates of doses from global fallout. *Health Phys* 82(5): 690-705 (2002).
- B26 Brues, A.M., A.N. Stroud and L. Rietz. Toxicity of tritium oxide to mice. *Proc Soc Exp Biol Med* 79(1): 174-176 (1952).
- B27 Bursian, S.J., D.F. Cahill, J.W. Laskey et al. Some aspects of brain neurochemistry after intrauterine exposure to tritium. *Int J Radiat Biol Relat Stud Phys Chem Med* 27(5): 455-461 (1975).
- B28 Butler, H.L. and J.H. Leroy. Observation of biological half-life of tritium. *Health Phys* 11(4): 283-285 (1965).
- C1 Cahill, D.F., J.F. Wright, J.H. Godbold et al. Neoplastic and life-span effects of chronic exposure to tritium. I. Effects on adult rats exposed during pregnancy. *J Natl Cancer Inst* 55(2): 371-374 (1975).
- C2 Cahill, D.F., J.F. Wright, J.H. Godbold et al. Neoplastic and life-span effects of chronic exposure to tritium. II. Rats exposed in utero. *J Natl Cancer Inst* 55(5): 1165-1169 (1975).

- C3 Cardis, E., E.S. Gilbert, L. Carpenter et al. Effects of low doses and low dose rates of external ionizing radiation: cancer mortality among nuclear industry workers in three countries. *Radiat Res* 142(2): 117-132 (1995).
- C4 Cardis, E., M. Vrijheid, M. Blettner et al. Risk of cancer after low doses of ionising radiation: retrospective cohort study in 15 countries. *Br Med J* 331(7508): 77 (2005).
- C5 Cardis, E., M. Vrijheid, M. Blettner et al. The 15-Country Collaborative Study of Cancer Risk among Radiation Workers in the Nuclear Industry: estimates of radiation-related cancer risks. *Radiat Res* 167(4): 396-416 (2007).
- C6 Carlisle, S.M., P.A. Burchart, C. McCauley et al. Biokinetics of inhaled radioactive methane in rats: a pilot study. *Appl Radiat Isot* 62(6): 847-860 (2005).
- C7 Carpenter, L., C. Higgins, A. Douglas et al. Combined analysis of mortality in three United Kingdom nuclear industry workforces, 1946-1988. *Radiat Res* 138(2): 224-238 (1994).
- C8 Carpenter, L.M., C.D. Higgins, A.J. Douglas et al. Cancer mortality in relation to monitoring for radionuclide exposure in three UK nuclear industry workforces. *Br J Cancer* 78(9): 1224-1232 (1998).
- C9 Carr, T.E. and J. Nolan. Testis mass loss in the mouse induced by tritiated thymidine, tritiated water, and  $^{60}\text{Co}$  gamma irradiation. *Health Phys* 36(2): 135-145 (1979).
- C10 Carsten, A.L. and S.L. Commerford. Dominant lethal mutations in mice resulting from chronic tritiated water (HTO) ingestion. *Radiat Res* 66(3): 609-614 (1976).
- C11 Carsten, A.L. Tritium in the environment: isotopic effects and transmutation. pp.419-458 in: *Advances in Radiation Biology* (J.T. Lett and H. Adler, eds.). Academic Press, New York, 1979.
- C12 Chebotina, M.Y. and O. Nikolin. Tritium water bodies in the area of PA Mayak. *Radiation Safety Issues* 1: 79-84 (2005). (Russian).
- C13 Chebotina, M.Y. and O.A. Nikolin. The current tritium concentrations in human urine in the area of nuclear fuel cycle facilities. *Dokl Biol Sci* 447(6): 390-391 (2012).
- C14 Chen, J. Radiation quality of tritium. *Radiat Prot Dosim* 122(1-4): 546-548 (2006).
- C15 Chen, J. Estimated yield of double-strand breaks from internal exposure to tritium. *Radiat Environ Biophys* 51(3): 295-302 (2012).
- C16 Chen, J. Radiation quality of tritium: a comparison with  $^{60}\text{Co}$  gamma rays. *Radiat Prot Dosim* 156(3): 372-375 (2013).
- C17 Cheng, Y.S., A.R. Dahl and H.N. Jow. Dissolution of metal tritides in a simulated lung fluid. *Health Phys* 73(4): 633-638 (1997).
- C18 Cheng, Y.S., M.B. Snipes, Y. Wang et al. Biokinetics and dosimetry of titanium tritide particles in the lung. *Health Phys* 76(2): 120-128 (1999).
- C19 Cheng, Y.S., Y. Zhou, Y.S. Wang et al. Dose estimate of inhaled hafnium tritide using the ICRP 66 lung model. *Health Phys* 82(6): 817-824 (2002).
- C20 Cheng, Y.S., M.B. Snipes, R.F. Kropf et al. Radiation dosimetry of metal tritides. *Health Phys* 68(6) Suppl.: S53 (1995).
- C21 Chopra, C. and J.A. Heddle. Cytogenetic measurements of the relative biological effectiveness of tritium. INFO-0287. Atomic Energy Control Board, Ottawa, Canada, 1988.
- C22 Clerici, L., M.J. Carroll, M. Merlini et al. The toxicity of tritium: the effects of tritiated amino-acids on preimplanted mouse embryos. *Int J Radiat Biol Relat Stud Phys Chem Med* 45(3): 245-250 (1984).

- C23 CNSC. Tritium releases and dose consequences in Canada in 2006. Part of the tritium studies project. INFO-0793. Canadian Nuclear Safety Commission, Ottawa, Ontario, 2009.
- C24 CODEX Alimentarius Commission. Codex general standard for contaminants and toxins in food and feed. CODEX STAN 193-1995. 2013.
- C25 Commerford, S.L., A.L. Carsten and E.P. Cronkite. The distribution of tritium in the glycogen, hemoglobin, and chromatin of mice receiving tritium in their drinking water. *Radiat Res* 72(2): 333-342 (1977).
- C26 Commerford, S.L., A.L. Carsten and E.P. Cronkite. The turnover of tritium in cell nuclei, chromatin, DNA, and histone. *Radiat Res* 92(3): 521-529 (1982).
- C27 Cool, D.A. and H.D. Maillie. Dissolution of tritiated glass microballoon fragments: implications for inhalation exposure. *Health Phys* 45(3): 791-794 (1983).
- C28 Cool, D.A. and H.D. Maillie. Tritium distribution and excretion following intratracheal instillation of glass microballoon fragments in rats. *Health Phys* 46(3): 599-606 (1984).
- C29 Cooper, J.R., M.R. Bailey, F.A. Fry et al. Guidance on the application of dose coefficients for the embryo and fetus from intakes of radionuclides by the mother. *Doc NRPB* 16(2): 2005.
- C30 Cox, R., H.G. Menzel and J. Preston. Internal dosimetry and tritium--the ICRP position. *J Radiol Prot* 28(2): 131-135 (2008).
- C31 Cragle, D.L., R.W. McLain, J.R. Qualters et al. Mortality among workers at a nuclear fuels production facility. *Am J Ind Med* 14(4): 379-401 (1988).
- C32 Cragle, D.L. and J.P. Watkins. Mortality among workers at the Savannah river nuclear fuels production facility. American Statistical Association, VA, 1999.
- D1 Daher, A., M. Varin, Y. Lamontagne et al. Effect of pre-conceptional external or internal irradiation of N5 male mice and the risk of leukemia in their offspring. *Carcinogenesis* 19(9): 1553-1558 (1998).
- D2 Daniels, R.D., S. Bertke, K.M. Waters et al. Risk of leukaemia mortality from exposure to ionising radiation in US nuclear workers: a pooled case-control study. *Occup Environ Med* 70(1): 41-48 (2013).
- D3 Delong, C.W., R.C. Thompson and H.A. Kornberg. Percutaneous absorption of tritium oxide. *Am J Roentgenol Radium Ther Nucl Med* 71(6): 1038-1045 (1954).
- D4 Di Pace, L., E. Letellier, H. Maubert et al. Biological hazard issues from potential releases of tritiated dust from ITER. *Fusion Eng Des* 83(10-12): 1729-1732 (2008).
- D5 Diabate, S. and S. Strack. Organically bound tritium. *Health Phys* 65(6): 698-712 (1993).
- D6 Dobson, R.L. and T.C. Kwan. The RBE of tritium radiation measured in mouse oocytes: increase at low exposure levels. *Radiat Res* 66(3): 615-625 (1976).
- D7 Dobson, R.L. and T.C. Kwan. The tritium RBE at low-level exposure--variation with dose, dose rate, and exposure duration. *Curr Top Radiat Res Q* 12(1-4): 44-62 (1978).
- D8 Douglas, A.J., R.Z. Omar and P.G. Smith. Cancer mortality and morbidity among workers at the Sellafield plant of British Nuclear Fuels. *Br J Cancer* 70(6): 1232-1243 (1994).
- E1 Eakins, J.D., W.P. Hutchinson and A.E. Lally. The radiological hazard from tritium sorbed on metal surfaces. *Health Phys* 28(3): 213-224 (1975).
- E2 Ellett, W.H. and L.A. Braby. The microdosimetry of 250 kVp and 65 kVp x rays, 60 Co gamma rays, and tritium beta particles. *Radiat Res* 51(2): 229-243 (1972).
- E3 Etnier, E.L., C.C. Travis and D.M. Hetrick. Metabolism of organically bound tritium in man. *Radiat Res* 100(3): 487-502 (1984).



- F1 Fairlie, I. Hypothesis to explain childhood cancer near nuclear power plants. *Int J Occup Environ Health* 16(3): 341-350 (2010).
- F2 Feinendegen, L.E. *Tritium-Labeled Molecules in Biology and Medicine*. Academic Press, New York, 1967.
- F3 Feinendegen, L.E. and V.P. Bond. Transmutation versus beta irradiation in the pathological effects of tritium decay. pp.221-231 in: *Tritium* (A.A. Moghissi and M.W. Carter, eds.). Messenger Graphics, Phoenix, 1973.
- F4 Feinendegen, L.E. and E.P. Cronkite. Effect of microdistribution of radionuclides on recommended limits in radiation protection, a model. *Curr Top Radiat Res Q* 12(1-4): 83-99 (1978).
- F5 Feinendegen, L.E., E.P. Cronkite and V.P. Bond. Radiation problems in fusion energy production. *Radiat Environ Biophys* 18(3): 157-183 (1980).
- F6 Fix, J.J., L. Salmon, G. Cowper et al. A retrospective evaluation of the dosimetry employed in an international combined epidemiological study. *Radiat Prot Dosim* 74(1-2): 39-53 (1997).
- F7 Fliedner, T.M., R.J. Haas, H. Stehle et al. Complete labeling of all cell nuclei in newborn rats with H3-thymidine. A tool for the evaluation of rapidly and slowly proliferating cell systems. *Lab Invest* 18(3): 249-259 (1968).
- F8 Forell, B., L.S. Myers, Jr. and A. Norman. DNA repair synthesis in minimally stressed human lymphocytes. *Int J Radiat Biol Relat Stud Phys Chem Med* 41(5): 535-545 (1982).
- F9 Fourré, E., P. Jean-Baptiste, A. Dapoigny et al. "Reference waters" in French laboratories involved in tritium monitoring: how tritium-free are they? *Radioprotection* 49(2): 143-145 (2014).
- F10 Foy, J.M. and H. Schnieden. Estimation of total body water (virtual tritium space) in the rat, cat, rabbit, guinea-pig and man, and of the biological half-life of tritium in man. *J Physiol* 154: 169-176 (1960).
- F11 Frankenberg, D., K. Kelnhofer, K. Bar et al. Enhanced neoplastic transformation by mammography X rays relative to 200 kVp X rays: indication for a strong dependence on photon energy of the RBE(M) for various end points. *Radiat Res* 157(1): 99-105 (2002).
- F12 Fraser, P., L. Carpenter, N. Maconochie et al. Cancer mortality and morbidity in employees of the United Kingdom Atomic Energy Authority, 1946-86. *Br J Cancer* 67(3): 615-624 (1993).
- F13 Furchner, J.E. Relative biological effectiveness of tritium beta-particles and Co60 gamma-rays measured by lethality in CF1 mice. *Radiat Res* 6(4): 483-490 (1957).
- F14 Furuno-Fukushi, I., A.M. Ueno and H. Matsudaira. Cell killing and mutation to 6-thioguanine resistance after exposure to tritiated amino acids and tritiated thymidine in cultured mammalian cells (L5178Y). *Radiat Res* 110(3): 428-438 (1987).
- G1 Galeriu, D. and A. Melintescu. Retention of tritium in reference persons: a metabolic model. Derivation of parameters and application of the model to the general public and to workers. *J Radiol Prot* 30(3): 445-468 (2010).
- G2 Gao, W.M., B. Wang and X.Y. Zhou. Effects of prenatal low-dose beta radiation from tritiated water on learning and memory in rats and their possible mechanisms. *Radiat Res* 152(3): 265-272 (1999).
- G3 Geard, C.R., R.D. Colvett and N. Rohrig. On the mechanics of chromosomal aberrations: a study with single and multiple spatially-associated protons. *Mutat Res* 69(1): 81-99 (1980).
- G4 Gillies, M. and R. Haylock. The cancer mortality and incidence experience of workers at British Nuclear Fuels plc, 1946-2005. *J Radiol Prot* 34(3): 595-623 (2014).

- G5 Goodhead, D.T. An assessment of the role of microdosimetry in radiobiology. *Radiat Res* 91(1): 45-76 (1982).
- G6 Goodhead, D.T. and H. Nikjoo. Current status of ultrasoft X rays and track structure analysis as tools for testing and developing biophysical models of radiation action. *Radiat Prot Dosim* 31(1-4): 343-350 (1990).
- G7 Goodhead, D.T. Soft x-ray radiobiology and synchrotron radiation. pp. 683-705 in: *Synchrotron Radiation in Biosciences* (B. Chance et al., eds.). Oxford University Press, Oxford, 1994.
- G8 Gracheva, L.M. and V.G. Korolev. *Genetic Effects of Radionuclide Decay in Cells*. Atomizdat, Moscow, 1977. (Russian).
- G9 Gragtman, N.J., D.K. Myers, J.R. Johnson et al. Occurrence of mammary tumors in rats after exposure to tritium beta rays and 200-kVp X rays. *Radiat Res* 99(3): 636-650 (1984).
- G10 Green, L.M., L. Dodds, A.B. Miller et al. Risk of congenital anomalies in children of parents occupationally exposed to low level ionising radiation. *Occup Environ Med* 54(9): 629-635 (1997).
- G11 Gribbin, M.A., J.L. Weeks and G.R. Howe. Cancer mortality (1956-1985) among male employees of Atomic Energy of Canada Limited with respect to occupational exposure to external low-linear-energy-transfer ionizing radiation. *Radiat Res* 133(3): 375-380 (1993).
- G12 Griffin, C.S., M.A. Hill, D.G. Papworth et al. Effectiveness of 0.28 keV carbon K ultrasoft X-rays at producing simple and complex chromosome exchanges in human fibroblasts in vitro detected using FISH. *Int J Radiat Biol* 73(6): 591-598 (1998).
- G13 Grosche, B., D. Lackland, L. Mohr et al. Leukaemia in the vicinity of two tritium-releasing nuclear facilities: a comparison of the Kruemmel Site, Germany, and the Savannah River Site, South Carolina, USA. *J Radiol Prot* 19(3): 243-252 (1999).
- H1 Haas, R.J., W. Schreml, T.M. Fliedner et al. The effect of tritiated water on the development of the rat oocyte after maternal infusion during pregnancy. *Int J Radiat Biol Relat Stud Phys Chem Med* 23(6): 603-609 (1973).
- H2 Hamby, D.M. Uncertainty of the tritium dose conversion factor. *Health Phys* 77(3): 291-297 (1999).
- H3 Hamra, G., L.A. Nylander-French and D. Richardson. Dose reconstruction for an occupational cohort at the Savannah River nuclear facility: evaluation of a hybrid method. *Radiat Prot Dosim* 131(2): 188-197 (2008).
- H4 Hamra, G., D. Richardson, R. Maclehorse et al. Integrating informative priors from experimental research with Bayesian methods: an example from radiation epidemiology. *Epidemiology* 24(1): 90-95 (2013).
- H5 Hamra, G.B., D.B. Richardson, E. Cardis et al. Cohort Profile: The International Nuclear Workers Study (INWORKS). *Int J Epidemiol* 45(3): 693-699 (2016).
- H6 Harrison, J.D., V.M. Levack and R. Kozlowski. Biokinetics, dosimetry and effects of tritium in the embryo and fetus. NRPB-M962. National Radiological Protection Board, Didcot, 1998.
- H7 Harrison, J.D., A. Khursheed and B.E. Lambert. Uncertainties in dose coefficients for intakes of tritiated water and organically bound forms of tritium by members of the public. *Radiat Prot Dosim* 98(3): 299-311 (2002).
- H8 Hazelton, W.D., S.H. Moolgavkar, S.B. Curtis et al. Biologically based analysis of lung cancer incidence in a large Canadian occupational cohort with low-dose ionizing radiation exposure, and comparison with Japanese atomic bomb survivors. *J Toxicol Environ Health A* 69(11): 1013-1038 (2006).

- H9 Henry, P. Etude d'une contamination accidentelle par l'eau tritíee. IAEA-SM-150/24. Symposium on Assessment of Radioactive Organ and Body Burdens, Stockholm, Sweden, 22-26 November 1971. pp.641-657. International Atomic Energy Agency, Vienna 1972. (French).
- H10 Hill, M.A., D.L. Stevens, K.M. Stuart Townsend et al. Comments on the recently reported low biological effectiveness of ultrasoft X rays. *Radiat Res* 155(3): 503-510 (2001).
- H11 Hill, M.A. The variation in biological effectiveness of X-rays and gamma rays with energy. *Radiat Prot Dosim* 112(4): 471-481 (2004).
- H12 Hill, R.L. and J.R. Johnson. Metabolism and dosimetry of tritium. *Health Phys* 65(6): 628-647 (1993).
- H13 Hisamatsu, S., Y. Takizawa, M. Itoh et al. Fallout <sup>3</sup>H in human tissue at Akita, Japan. *Health Phys* 57(4): 559-563 (1989).
- H14 Hisamatsu, S., T. Ohmura, Y. Takizawa et al. Tritium level in Japanese diet and human tissue. *J Radioanal Nucl Chem* 156(1): 89-102 (1992).
- H15 Hodgson, S.A., J.E. Scott and A. Hodgson. In vitro dissolution of tritium-loaded particles from the JET fusion machine. *Radiat Prot Dosim* 127(1-4): 55-59 (2007).
- H16 HPA. Review of risks from tritium. RCE-4. Health Protection Agency, Chilton, 2007.
- H17 HSE. HSE investigation of leukaemia and other cancers in the children of male workers at Sellafield. Health and Safety Executive, Sudbury, UK, 1993.
- H18 HSE. HSE investigation of leukaemia and other cancers in the children of male workers at Sellafield: Review of results published in October 1993. Health and Safety Executive, Sudbury, UK, 1994.
- H19 Hunt, J., T. Bailey and A. Reese. The human body retention time of environmental organically bound tritium. *J Radiol Prot* 29(1): 23-36 (2009).
- H20 Hunter, N., I.S. Kuznetsova, E.V. Labutina et al. Solid cancer incidence other than lung, liver and bone in Mayak workers: 1948-2004. *Br J Cancer* 109(7): 1989-1996 (2013).
- I1 IAEA. Environmental Isotope Data No. 1: World survey of isotope concentration in precipitation (1953-1963). Technical Reports Series No. 96. International Atomic Energy Agency, Vienna, 1969.
- I2 IAEA. Management of tritium at nuclear facilities. Technical Reports Series No. 234. International Atomic Energy Agency, Vienna, 1984.
- I3 IAEA. Safe handling of tritium. Review of data and experience. Technical Reports Series No. 324. International Atomic Energy Agency, Vienna, 1991.
- I4 IAEA. Radiation protection and safety of radiation sources: International basic safety standards. General safety requirements Part 3. IAEA Safety Standards Series No. GSR Part 3. International Atomic Energy Agency, Vienna, 2014.
- I5 IARC. Direct estimates of cancer mortality due to low doses of ionising radiation: an international study. IARC Study Group on Cancer Risk among Nuclear Industry Workers. *Lancet* 344(8929): 1039-1043 (1994).
- I6 Ichimasa, Y., M. Ichimasa, T. Shiba et al. Fixation of tritium gas by rats. *Radiat Prot Dosim* 16(1-2): 127-130 (1986).
- I7 ICRP. Report on the task group on reference man. ICRP Publication 23. International Commission on Radiological Protection, Pergamon Press, Oxford, 1975.
- I8 ICRP. Limits for intakes of radionuclides by workers. ICRP Publication 30 (Part 1). *Annals of the ICRP* 2(3-4). International Commission on Radiological Protection, Pergamon Press, Oxford, 1979.

- I19 ICRP. Limits for intakes of radionuclides by workers. ICRP Publication 30 (Part 2). Annals of the ICRP 4(3-4). International Commission on Radiological Protection, Pergamon Press, Oxford, 1980.
- I110 ICRP. Limits for intakes of radionuclides by workers. ICRP Publication 30 (Part 3). Annals of the ICRP 6(2-3). International Commission on Radiological Protection, Pergamon Press, Oxford, 1981.
- I111 ICRP. Nonstochastic effects of ionizing radiation. ICRP Publication 41. Annals of the ICRP 14(3). International Commission on Radiological Protection, Pergamon Press, Oxford, 1984.
- I112 ICRP. Age-dependent doses to members of the public from intake of radionuclides: Part 1. ICRP Publication 56. Annals of the ICRP 20(2). International Commission on Radiological Protection, Pergamon Press, Oxford, 1990.
- I113 ICRP. 1990 Recommendations of the International Commission on Radiological Protection. ICRP Publication 60. Annals of the ICRP 21(1-3). International Commission on Radiological Protection, Pergamon Press, Oxford, 1991.
- I114 ICRP. Age-dependent doses to members of the public from intake of radionuclides: Part 2. Ingestion dose coefficients. ICRP Publication 67. Annals of the ICRP 23(3-4). International Commission on Radiological Protection, Pergamon Press, Oxford, 1993.
- I115 ICRP. Dose coefficients for intakes of radionuclides by workers. ICRP Publication 68. Annals of the ICRP 24(4). International Commission on Radiological Protection, Pergamon Press, Oxford, 1994.
- I116 ICRP. Human respiratory tract model for radiological protection. ICRP Publication 66. Annals of the ICRP 24(1-3). International Commission on Radiological Protection, Pergamon Press, Oxford, 1994.
- I117 ICRP. Age-dependent doses to members of the public from intake of radionuclides: Part 4. Inhalation dose coefficients. ICRP Publication 71. Annals of the ICRP 25(3-4). International Commission on Radiological Protection, Pergamon Press, Oxford, 1995.
- I118 ICRP. Doses to the embryo and fetus from intakes of radionuclides by the mother. ICRP Publication 88. Annals of the ICRP 31(1-3). International Commission on Radiological Protection, Pergamon Press, Oxford, 2001.
- I119 ICRP. Basic anatomical and physiological data for use in radiological protection: reference values. ICRP Publication 89. Annals of the ICRP 32(3-4). International Commission on Radiological Protection, Pergamon Press, Oxford, 2002.
- I120 ICRP. Relative biological effectiveness (RBE), quality factor (Q), and radiation weighting factor (w<sub>R</sub>). ICRP Publication 92. Annals of the ICRP 33(4). International Commission on Radiological Protection, Pergamon Press, Oxford, 2003.
- I121 ICRP. Doses to infants from ingestion of radionuclides in mothers' milk. ICRP Publication 95. Annals of the ICRP 34(3-4). International Commission on Radiological Protection, Elsevier Ltd., 2004.
- I122 ICRP. Assessing dose of the representative person for the purpose of the radiation protection of the public. ICRP Publication 101a. Annals of the ICRP 36(3). International Commission on Radiological Protection, Elsevier, 2006.
- I123 ICRP. The 2007 Recommendations of the International Commission on Radiological Protection. ICRP Publication 103. Annals of the ICRP 37(2-4). International Commission on Radiological Protection, Elsevier Ltd., 2007.
- I124 ICRU. Linear energy transfer. ICRU Report 16. International Commission on Radiation Units and Measurements, Washington, D.C., 1970.

- I25 ICRU. The quality factor in radiation protection. ICRU Report 40. International Commission on Radiation Units and Measurements, Bethesda, 1986.
- I26 Ijiri, K. Cell death (apoptosis) in mouse intestine after continuous irradiation with gamma rays and with beta rays from tritiated water. *Radiat Res* 118(1): 180-191 (1989).
- J1 Jacobs, D.G. Sources of tritium and its behavior upon release to the environment. U.S. Atomic Energy Commission, Division of Technical Information, Tennessee, 1968.
- J2 Jain, N. and A.L. Bhatia. Radiobiological effects of low doses of tritiated water on developing mouse cerebellum from 17th day post-coitum. *Indian J Exp Biol* 34(9): 891-894 (1996).
- J3 Johnson, J.R. The estimation of the effective dose equivalent from tritiated water exposures using tritium concentrations in urine. *Radiat Prot Dosim* 2(4): 245-247 (1982).
- J4 Johnson, J.R. and D.W. Dunford. Dosimetric models of  $^3\text{H}$  from skin absorption following contact with T2-contaminated surfaces. *Health Phys* 48(1): 110-113 (1985).
- J5 Johnson, J.R., D.K. Myers, J.S. Jackson et al. Relative biological effectiveness of tritium for induction of myeloid leukemia in CBA/H mice. *Radiat Res* 144(1): 82-89 (1995).
- J6 Johnson, K.C. and J. Rouleau. Tritium releases from the pickering nuclear generating station and birth defects and infant mortality in nearby communities 1971-1988. INFO-0401. Atomic Energy Control Board, Ottawa, Canada, 1991.
- J7 Johnson, P., W.D. Atkinson and J.L. Nicholls. Updated analysis of mortality in workers at UK atomic weapons establishments. Proceedings of the SRP Sixth International Symposium: Achievements & Challenges: Advancing Radiation Protection into the 21st Century, Southport. Society for Radiological Protection, London, 1999.
- J8 Jones, D.C., J.S. Krebs, D.P. Sasmore et al. Evaluation of neonatal squirrel monkeys receiving tritiated water throughout gestation. *Radiat Res* 83(3): 592-606 (1980).
- K1 Kacena, V. Chemical effects of decay of incorporated radioisotopes. pp.190-210 in: *Biological Effects of Transmutation and Decay of Incorporated Radioisotopes*, Proceedings of a Panel, Vienna, 9-13 October 1967. International Atomic Energy Agency, Vienna, 1968.
- K2 Kakiuchi, H., N. Akata, H. Hasegawa et al. Concentration of ( $^3\text{H}$ ) in plants around Fukushima Dai-ichi Nuclear Power Station. *Sci Rep* 2: 947 (2012).
- K3 Kamiguchi, Y., H. Tateno and K. Mikamo. Dose-response relationship for the induction of structural chromosome aberrations in human spermatozoa after in vitro exposure to tritium beta-rays. *Mutat Res* 228(2): 125-131 (1990).
- K4 Kamiguchi, Y., H. Tateno and K. Mikamo. Types of structural chromosome aberrations and their incidences in human spermatozoa X-irradiated in vitro. *Mutat Res* 228(2): 133-140 (1990).
- K5 Kazachenok, N., I. Popova, V. Melnikov et al. Pattern of  $^3\text{H}$  distribution in surface water bodies and drinking water supply sources in the area of PA Mayak influence. ANRI 3: 43-51 (2013). (Russian).
- K6 Kazachenok, N., V. Kostyuchenko, I. Popova et al. Contemporary levels of radioactive contamination of environmental objects at EURT and other territories in the area of PA Mayak influence. *Radiation Safety Issues* 1: 33-48 (2014). (Russian).
- K7 Kellerer, A.M. and H.H. Rossi. RBE and the primary mechanism of radiation action. *Radiat Res* 47(1): 15-34 (1971).
- K8 Kellerer, A.M., Y.M. Lam and H.H. Rossi. Biophysical studies with spatially correlated ions. 4. Analysis of cell survival data for diatomic deuterium. *Radiat Res* 83(3): 511-528 (1980).
- K9 Kellerer, A.M. Electron spectra and the RBE of X rays. *Radiat Res* 158(1): 13-22 (2002).

- K10 Kelly, S.J. and J. Rossant. The effect of short-term labelling in (3H) thymidine on the viability of mouse blastomeres: alone and in combination with unlabelled blastomeres. *J Embryol Exp Morphol* 35(1): 95-106 (1976).
- K11 Kember, N.F. and B.E. Lambert. Slowly cycling cells in growing bone. *Cell Tissue Kinet* 14(3): 327-330 (1981).
- K12 Killen, H.M. and J. Carroll. The effects of tritium on embryo development: the embryotoxic effects of [3H]tryptophan. *Int J Radiat Biol* 56(2): 139-149 (1989).
- K13 Kim, C.K. and M.J. Han. Dose assessment and behavior of tritium in environmental samples around Wolsong nuclear power plant. *Appl Radiat Isot* 50(4): 783-791 (1999).
- K14 Kim, S.B., N. Baglan and P.A. Davis. Current understanding of organically bound tritium (OBT) in the environment. *J Environ Radioact* 126: 83-91 (2013).
- K15 Kirchmann, R., S. Bonotto, S.D. Soman et al. Transfer and incorporation of tritium in aquatic organisms. pp.187-203 in: *Behaviour of Tritium in the Environment*. Proceedings series. International Atomic Energy Agency, Vienna, 1979.
- K16 Kirillova, E.N. and V.M. Luzanov. Mouse immune response to prolonged tritium oxide intake. *Radiobiologiya* 20(4): 560-565 (1980). (Russian).
- K17 Kirillova, E.N. Normal killer function in CBA mice as affected by long-term intake of tritium oxide. *Radiobiologiya* 25(6): 792-795 (1985). (Russian).
- K18 Kirillova, E.N., V.M. Manko and K.N. Muksinova. Recovery of humoral immunity parameters in mice under a long-term action of tritium oxide. *Immunologiya* 2: 38-41 (1986). (Russian).
- K19 Kirillova, E.N. The immunity indices of rats after the long-term action of tritium oxide or gamma irradiation. *Radiobiologiya* 30(2): 175-178 (1990). (Russian).
- K20 Kocher, D.C., A.I. Apostoaei and F.O. Hoffman. Radiation effectiveness factors for use in calculating probability of causation of radiogenic cancers. *Health Phys* 89(1): 3-32 (2005).
- K21 Komatsu, K., Y. Okumura and K. Sakamoto. Radiation dose to mouse liver cells from ingestion of tritiated food or water. *Health Phys* 58(5): 625-629 (1990).
- K22 Kowalska, M. Incorporation of tritiated water (HTO) and organically bound tritium (OBT) into phospholipids and gangliosides of rat brain. *J Radiat Res* 26(4): 385-394 (1985).
- K23 Kowalska, M. Incorporation of tritiated water (HTO) or organically bound tritium (OBT) into amino acids of rat brain proteins. *J Radiat Res* 26(1): 99-108 (1985).
- K24 Kozlowski, R., S.D. Bouffler, J.W. Haines et al. In utero haemopoietic sensitivity to alpha, beta or X-irradiation in CBA/H mice. *Int J Radiat Biol* 77(7): 805-815 (2001).
- L1 Lambert, B.E. and R.J. Clifton. Radiation doses resulting from the administration of tritiated folic acid and tritiated water to the rat. *Br J Radiol* 40(469): 56-61 (1967).
- L2 Lambert, B.E. and R.J. Clifton. Radiation doses resulting from the ingestion of tritiated thymidine by the rat. *Health Phys* 15(1): 3-9 (1968).
- L3 Lambert, B.E. Cytological damage produced in the mouse testes by tritiated thymidine, tritiated water and x-rays. *Health Phys* 17(4): 547-557 (1969).
- L4 Lambert, B.E., H.B. Sharpe and K.B. Dawson. An accidental intake of tritiated water. *Am Ind Hyg Assoc J* 32(10): 682-686 (1971).
- L5 Lambert, B.E. and J. Vennart. Radiation doses received by workers using tritium in industry. *Health Phys* 22(1): 23-30 (1972).
- L6 Lambert, B.E. and M.L. Phipps. Some effects of irradiation of mice in utero with tritiated compounds. *Curr Top Radiat Res Q* 12(1-4): 197-211 (1978).

- L7 Laskey, J.W., J.L. Parrish and D.F. Cahill. Some effects of lifetime parental exposure to low levels of tritium on the F2 generation. *Radiat Res* 56(1): 171-179 (1973).
- L8 Leggett, R.W., A. Bouville and K.F. Eckerman. Reliability of the ICRP's systemic biokinetic models. *Radiat Prot Dosim* 79(1-4): 335-342 (1998).
- L9 Leuraud, K., D.B. Richardson, E. Cardis et al. Ionising radiation and risk of death from leukaemia and lymphoma in radiation-monitored workers (INWORKS): an international cohort study. *Lancet Haematol* 2(7): e276-e281 (2015).
- L10 Libby, W.F. Atmospheric helium three and radiocarbon from cosmic radiation. *Phys Rev* 69(11-12): 671-672 (1946).
- L11 Little, J.B. Induction of neoplastic transformation by low-dose-rate exposure to tritiated water. *Radiat Res* 107(2): 225-233 (1986).
- L12 Little, M.P. and B.E. Lambert. Systematic review of experimental studies on the relative biological effectiveness of tritium. *Radiat Environ Biophys* 47(1): 71-93 (2008).
- L13 Lushbaugh, C.C. and R.C. Ricks. Some cytokinetic and histopathologic considerations of irradiated male and female gonadal tissues. *Front Radiat Ther Oncol* 6: 228-248 (1972).
- L14 Lushbaugh, C.C. and G.W. Casarett. The effects of gonadal irradiation in clinical radiation therapy: a review. *Cancer* 37(2 Suppl): 1111-1125 (1976).
- M1 Martin, J.R. and J.J. Koranda. Biological half-life studies of tritium in chronically exposed kangaroo rats. *Radiat Res* 50(2): 426-440 (1972).
- M2 Mathur-De Vre, R. and J. Binet. Molecular aspects of tritiated water and natural water in radiation biology. *Prog Biophys Mol Biol* 43(2): 161-193 (1984).
- M3 Matsuda, Y., T. Yamada and I. Tobari. Chromosome aberrations induced by tritiated water or <sup>60</sup>Co gamma-rays at early pronuclear stage in mouse eggs. *Mutat Res* 160(2): 87-93 (1986).
- M4 Matsumoto, T., T. Maruoka, G. Shimoda et al. Tritium in Japanese precipitation following the March 2011 Fukushima Daiichi Nuclear Plant accident. *Sci Total Environ* 445-446: 365-370 (2013).
- M5 McGeoghegan, D. and K. Binks. The mortality and cancer morbidity experience of workers at the Capenhurst uranium enrichment facility 1946-95. *J Radiol Prot* 20(4): 381-401 (2000).
- M6 McGeoghegan, D. and K. Binks. The mortality and cancer morbidity experience of employees at the Chapelcross plant of British Nuclear Fuels plc, 1955-95. *J Radiol Prot* 21(3): 221-250 (2001).
- M7 McGeoghegan, D., M. Gillies, A.E. Riddell et al. Mortality and cancer morbidity experience of female workers at the British Nuclear Fuels Sellafield plant, 1946-1998. *Am J Ind Med* 44(6): 653-663 (2003).
- M8 McGeoghegan, D., K. Binks, M. Gillies et al. The non-cancer mortality experience of male workers at British Nuclear Fuels plc, 1946-2005. *Int J Epidemiol* 37(3): 506-518 (2008).
- M9 McLaughlin, J.R., W.D. King, T.W. Anderson et al. Paternal radiation exposure and leukaemia in offspring: the Ontario case-control study. *Br Med J* 307(6910): 959-966 (1993).
- M10 Melintescu, A., D. Galeriu and H. Takeda. Reassessment of tritium dose coefficients for the general public. *Radiat Prot Dosim* 127(1-4): 153-157 (2007).
- M11 Metz-Flamant, C., O. Laurent, E. Samson et al. Mortality associated with chronic external radiation exposure in the French combined cohort of nuclear workers. *Occup Environ Med* 70(9): 630-638 (2013).
- M12 Mewissen, D.J., A.S. Ugarte and J.H. Rust. Genetic effects from exposure of male mice to tritium for six generations. *Radiat Res* 70: 629-640 (1977).

- M13 Mewissen, D.J. and A.S. Ugarte. Cumulative genetic effects from exposure of male mice to tritium for ten generations. pp.215-229 in: Proceedings of International Symposium on Biological Implications of Radionuclides Released from Nuclear Industries, Vienna, 26-30 March 1979. International Atomic Energy Agency, Vienna, 1979.
- M14 Milacic, S. Changes in leukocytes caused by tritium contamination. *Health Phys* 86(5): 457-459 (2004).
- M15 Minder, W. Internal contamination with tritium. *Strahlentherapie* 137(6): 700-704 (1969). (German).
- M16 Moghissi, A.A., M.W. Carter and E.W. Bretthauer. Further studies on the long-term evaluation of the biological half-life of tritium. *Health Phys* 23(6): 805-806 (1972).
- M17 Moiseenko, V.V., A.J. Walker and W.V. Prestwich. Energy deposition pattern from tritium and different energy photons--a comparative study. *Health Phys* 73(2): 388-392 (1997).
- M18 Moiseenko, V.V., R.N. Hamm, A.J. Waker et al. Calculation of radiation-induced DNA damage from photons and tritium beta-particles. Part I: Model formulation and basic results. *Radiat Environ Biophys* 40(1): 23-31 (2001).
- M19 Moiseenko, V.V., A.J. Waker, R.N. Hamm et al. Calculation of radiation-induced DNA damage from photons and tritium beta-particles. Part II: Tritium RBE and damage complexity. *Radiat Environ Biophys* 40(1): 33-38 (2001).
- M20 Morstin, K., M. Kopec, P. Olko et al. Microdosimetry of tritium. *Health Phys* 65(6): 648-656 (1993).
- M21 Moseeva, M.B., T.V. Azizova, E.S. Grigoryeva et al. Risks of circulatory diseases among Mayak PA workers with radiation doses estimated using the improved Mayak Worker Dosimetry System 2008. *Radiat Environ Biophys* 53(2): 469-477 (2014).
- M22 Muirhead, C.R., J.A. O'Hagan, R.G. Haylock et al. Mortality and cancer incidence following occupational radiation exposure: third analysis of the National Registry for Radiation Workers. *Br J Cancer* 100(1): 206-212 (2009).
- M23 Muller, W.U. and A. Spindle. Induction of sister chromatid exchange in preimplantation mouse embryos in vitro by 3H-thymidine or ultraviolet light in combination with caffeine. *Teratog Carcinog Mutagen* 6(2): 107-114 (1986).
- M24 Muller, W.U., C. Streffer, M. Molls et al. Radiotoxicities of [3H]thymidine and of [3H]arginine compared in mouse embryos in vitro. *Radiat Res* 110(2): 192-198 (1987).
- M25 Muller, W.U., N. Heckeley and C. Streffer. Effects of cell cycle specific exposure to 3H-thymidine or 3H-arginine on development and cell proliferation of mouse embryos. *Radiat Environ Biophys* 35(4): 267-271 (1996).
- M26 Myers, D.K. and J.R. Johnson. Toxicity and dosimetry of tritium: a review. INFO-0377. Atomic Energy Control Board, Advisory Committee on Radiological Protection, Ottawa, Canada, 1991.
- N1 NCRP. Tritium and other radionuclide labeled organic compounds incorporated in genetic material. NCRP Report No. 63. National Council on Radiation Protection and Measurements, Bethesda, 1979.
- N2 NCRP. Tritium in the environment. NCRP Report No. 62. National Council on Radiation Protection and Measurements, Bethesda, 1979.
- N3 NCRP. Influence of dose and its distribution in time on dose-response relationships for low-LET radiations. NCRP Report No. 64. National Council on Radiation Protection and Measurements, Bethesda, 1980.



- N4 NCRP. Uncertainties in internal radiation dose assessment. NCRP Report No. 164. National Council on Radiation Protection and Measurements, Bethesda, 2009.
- N5 Nikjoo, H. and D.T. Goodhead. Track structure analysis illustrating the prominent role of low-energy electrons in radiobiological effects of low-LET radiations. *Phys Med Biol* 36(2): 229-238 (1991).
- N6 NRC. Health effects of exposure to low levels of ionizing radiation. Committee on the Biological Effects of Ionizing Radiations, BEIR V. National Research Council, National Academy Press, Washington D.C., 1990.
- N7 NRC. Health risks from exposure to low levels of ionizing radiation. Committee to Assess Health Risks from Exposure to Low Levels of Ionizing Radiation, BEIR VII - Phase 2. National Research Council, The National Academies Press, Washington D.C., 2006.
- O1 Okada, S., K. Sakai and N. Nakamura. Relative biological effectiveness of tritiated water on cultured mammalian cells at molecular and cellular level. *Radiat Prot Dosim* 16(1-2): 137-140 (1986).
- O2 Okada, S. and N. Momoshima. Overview of tritium: characteristics, sources, and problems. *Health Phys* 65(6): 595-609 (1993).
- O3 Okladnikova, N.D., V.F. Khoryakov and E.V. Odintsova. The case of radiation sickness caused by exposure to tritium. *Med Radiol* 6: 595-609 (1969). (Russian).
- O4 Oliphant, M., P. Harteck and L. Rutherford. Transmutation effects observed with heavy hydrogen. *Proc R Soc London Ser A*: 692-703 (1934).
- O5 Omar, R.Z., J.A. Barber and P.G. Smith. Cancer mortality and morbidity among plutonium workers at the Sellafield plant of British Nuclear Fuels. *Br J Cancer* 79(7-8): 1288-1301 (1999).
- O6 Osborne, R.V. Absorption of tritiated water vapour by people. *Health Phys* 12(11): 1527-1537 (1966).
- P1 Painter, R.B., R.M. Drew and W.L. Hughes. Inhibition of HeLa growth by intranuclear tritium. *Science* 127(3308): 1244-1245 (1958).
- P2 Paquet, F. and H. Metivier. Are the risks from tritium exposures being underestimated? *J Radiol Prot* 29(2): 175-181 (2009).
- P3 Peterman, B.F., J.R. Johnson, R.G. Dunford et al. Internal dosimetry of tritiated hydrogen gas. CFFTP-G-84034. Canadian Fusion Fuels Technology Project, Ottawa, 1985.
- P4 Peterman, B.F., J.R. Johnson and R.G.C. McElroy. HT/HTO conversion in mammals. *Int J Appl Radiat Isot* 36(7): 600 (1985).
- P5 Phipps, A.W., G.M. Kendall, T.P. Fell et al. Doses from radioactive methane. *Radiat Prot Dosim* 30(3): 191-195 (1990).
- P6 Pietrzak-Flis, Z., I. Radwan and L. Indeka. Tritium in rabbits after ingestion of freeze-dried tritiated food and tritiated water. *Radiat Res* 76(2): 420-428 (1978).
- P7 Pietrzak-Flis, Z., I. Radwan, Z. Major et al. Tritium incorporation in rats chronically exposed to tritiated food or tritiated water for three successive generations. *J Radiat Res* 22(4): 434-442 (1981).
- P8 Pietrzak-Flis, Z. and M. Wasilewska-Gomulka. Effect of lifetime intake of organically bound tritium and tritiated water on the oocytes of rats. *Radiat Environ Biophys* 23(1): 61-68 (1984).
- P9 Pinson, E.A. and W.H. Langham. Physiology and toxicology of tritium in man. *J Appl Physiol* 10(1): 108-126 (1957).

- P10 Pomerantseva, M.D., M.I. Balonov, L.K. Ramaiia et al. Mutagenic action of tritium on the germ cells of male mice. II. The genetic damages in stem spermatogonia induced by tritium oxide and gamma radiation. *Genetika* 20(5): 782-787 (1984). (Russian).
- P11 Povinec, P.P., M. Aoyama, D. Biddulph et al. Cesium, iodine and tritium in NW Pacific waters – a comparison of the Fukushima impact with global fallout. *Biogeosciences* 10(8): 5481-5496 (2013).
- P12 Preston, D.L., Y. Shimizu, D.A. Pierce et al. Studies of mortality of atomic bomb survivors. Report 13: Solid cancer and noncancer disease mortality: 1950-1997. *Radiat Res* 160(4): 381-407 (2003).
- P13 Preston, D.L., E. Ron, S. Tokuoka et al. Solid cancer incidence in atomic bomb survivors: 1958-1998. *Radiat Res* 168(1): 1-64 (2007).
- P14 Prosser, J.S., D.C. Lloyd, A.A. Edwards et al. The introduction of chromosome aberrations in human lymphocytes by exposure to tritiated water in vitro. *Radiat Prot Dosim* 4(1): 21-26 (1983).
- R1 Revina, V.S., V.S. Voronin, V.K. Lemberg et al. Comparative evaluation of the carcinogenic effects of chronic exposure to tritium oxide and external gamma-radiation. *Radiobiologija* 24(5): 697-700 (1984). (Russian).
- R2 Richardson, D.B. and S. Wing. Leukemia mortality among workers at the Savannah River Site. *Am J Epidemiol* 166(9): 1015-1022 (2007).
- R3 Richardson, D.B., S. Wing and S. Wolf. Mortality among workers at the Savannah River Site. *Am J Ind Med* 50(12): 881-891 (2007).
- R4 Richardson, D.B. and S. Wing. Evidence of confounding by smoking of associations between radiation and lung cancer mortality among workers at the Savannah River Site. *Am J Ind Med* 54(6): 421-427 (2011).
- R5 Richardson, D.B., E. Cardis, R.D. Daniels et al. Risk of cancer from occupational exposure to ionising radiation: retrospective cohort study of workers in France, the United Kingdom, and the United States (INWORKS). *Br Med J* 351: h5359 (2015).
- R6 Richardson, R.B., D.W. Dunford and S.R. Peterson. Influence of gender differences in the carbon pool on dose factors for intakes of tritium and <sup>14</sup>C-labeled compounds. *Health Phys* 81(3): 302-312 (2001).
- R7 Richardson, R.B. and A. Hong. Dose to lung from inhaled tritiated particles. *Health Phys* 81(3): 313-324 (2001).
- R8 Richardson, R.B. and D.W. Dunford. A biochemical-based model for the dosimetry of dietary organically bound tritium--Part 2: Dosimetric evaluation. *Health Phys* 85(5): 539-552 (2003).
- R9 Richardson, R.B. and D.W. Dunford. A biochemical-based model for the dosimetry of dietary organically bound tritium--Part 1: Physiological criteria. *Health Phys* 85(5): 523-538 (2003).
- R10 Richter, B.S. and H.G. Stockwell. Descriptive study of deaths from cancer associated with residential proximity to the site of underground nuclear detonations. *Arch Environ Health* 53(2): 109-113 (1998).
- R11 Rochalska, M. and Z. Szot. The incorporation of organically-bound tritium of food into some organs of the rat. *Int J Radiat Biol Relat Stud Phys Chem Med* 31(4): 391-395 (1977).
- R12 Rodgers, D.W. Tritium dynamics in mice exposed to tritiated water and diet. *Health Phys* 63(3): 331-337 (1992).
- R13 Rodriguez-Rodrigo, L., J. Elbez-Uzan and C. Alejaldre. Tritium and workers in fusion devices-lessons learnt. *J Radiol Prot* 29(3): 351-360 (2009).
- R14 Rooney, C., V. Beral, N. Maconochie et al. Case-control study of prostatic cancer in employees of the United Kingdom Atomic Energy Authority. *Br Med J* 307(6916): 1391-1397 (1993).

- R15 Rudran, K. Radiation doses to lungs and whole body from use of tritium in luminous paint industry. *Radiat Prot Dosim* 25(2): 117-125 (1988).
- R16 Rudran, K. Significance of in vivo organic binding of tritium following intake of tritiated water. *Radiat Prot Dosim* 25(1): 5-13 (1988).
- R17 Russell, W.L., R.R. Cumming, E.M. Kelly et al. Induction of specific locus mutations in the mouse by tritiated water. pp.489-497 in: *Proceedings of the International Symposium on the Behaviour of Tritium in the Environment*. International Atomic Energy Agency, Vienna, 1979.
- S1 Saito, M., M.R. Ishida and C.C. Travis. Dose-modification factor for accumulated dose to cell nucleus due to protein-bound <sup>3</sup>H. *Health Phys* 56(6): 869-874 (1989).
- S2 Sanders Jr., S.M. and W.C. Reinig. Assessment of tritium in man. pp.534-542 in: *Diagnosis and Treatment of Deposited Radionuclides* (H.A. Kornberg and W.D. Norwood, eds.). Excerpta Medica Foundation, Amsterdam, 1968.
- S3 Sasaki, M.S. Primary damage and fixation of chromosomal DNA as probed by monochromatic soft x-rays and low-energy neutrons. pp.369-384 in: *The Early Effects of Radiation on DNA* (E.M. Fielden and P. O'Neill, eds.). Springer-Verlag, Berlin, 1991.
- S4 Satow, Y., H. Hori and J.Y. Lee. Teratogenic effect of fission neutron and tritium water on rat embryo. *J UOEH* 11 Suppl: 416-431 (1989).
- S5 Satow, Y., H. Hori, J.Y. Lee et al. Effect of tritiated water on female germ cells: mouse oocyte killing and RBE. *Int J Radiat Biol* 56(3): 293-299 (1989).
- S6 Schmid, E. Is there reliable experimental evidence for a low-dose RBE of about 4 for mammography X rays relative to 200 kV X rays? *Radiat Res* 158(6): 778-781 (2002).
- S7 Schreml, W., R.J. Haas, F. Planas-Bohne et al. Distribution and dosimetry of tritium in newborn rats after in utero exposure to <sup>3</sup>H-TdR. *Radiat Res* 58(2): 239-252 (1974).
- S8 Schreml, W. and T.M. Fliedner. Distribution of tritiated compounds (tritiated thymidine and tritiated water) in the mother-fetus system and its consequences for the radiotoxic effect of tritium. *Curr Top Radiat Res Q* 12(1-4): 255-277 (1978).
- S9 Schubauer-Berigan, M.K., R.D. Daniels, D.A. Fleming et al. Chronic lymphocytic leukaemia and radiation: findings among workers at five US nuclear facilities and a review of the recent literature. *Br J Haematol* 139(5): 799-808 (2007).
- S10 Schubauer-Berigan, M.K., R.D. Daniels, D.A. Fleming et al. Risk of chronic myeloid and acute leukemia mortality after exposure to ionizing radiation among workers at four U.S. nuclear weapons facilities and a nuclear naval shipyard. *Radiat Res* 167(2): 222-232 (2007).
- S11 Schubauer-Berigan, M.K., R.D. Daniels, S.J. Bertke et al. Cancer mortality through 2005 among a pooled cohort of U.S. nuclear workers exposed to external ionizing radiation. *Radiat Res* 183(6): 620-631 (2015).
- S12 Seelentag, W. Two cases of tritium fatality. pp.267-280 in: *Tritium* (A.A. Moghissi and M.W. Carter, eds.). Messenger Graphics, Phoenix, 1973.
- S13 Seyama, T., O. Yamamoto, A. Kinomura et al. Carcinogenic effects of tritiated water (HTO) in mice: in comparison to those of neutrons and gamma-rays. *J Radiat Res* 32 Suppl 2: 132-142 (1991).
- S14 Smirnov, D.G., E.N. Kirillova and K.N. Muksinova. The early changes in humoral immunity under the prolonged action of tritium oxide with different dose rates. *Radiobiologiya* 30(1): 129-133 (1990). (Russian).
- S15 Smith, P.G. and A.J. Douglas. Mortality of workers at the Sellafield plant of British Nuclear Fuels. *Br Med J (Clin Res Ed)* 293(6551): 845-854 (1986).

- S16 Snow, M.H. Abnormal development of pre-implantation mouse embryos grown in vitro with (3 H) thymidine. *J Embryol Exp Morphol* 29(3): 601-615 (1973).
- S17 Snyder, W.S., B.R. Fish, S.R. Bernard et al. Urinary excretion of tritium following exposure of man to HTO--a two exponential model. *Phys Med Biol* 13(4): 547-559 (1968).
- S18 Sokolnikov, M., D. Preston, E. Gilbert et al. Radiation effects on mortality from solid cancers other than lung, liver, and bone cancer in the Mayak worker cohort: 1948-2008. *PLoS One* 10(2): e0117784 (2015).
- S19 Sont, W.N., J.M. Zielinski, J.P. Ashmore et al. First analysis of cancer incidence and occupational radiation exposure based on the National Dose Registry of Canada. *Am J Epidemiol* 153(4): 309-318 (2001).
- S20 Soyfer, V.N., V. Goryachev, S. Vakulovsky et al. Tritium Studies of Russia's Natural Waters. Geos, Russia, 2007. (Russian).
- S21 Spindle, A., K. Wu and R.A. Pedersen. Sensitivity of early mouse embryos to [3H]thymidine. *Exp Cell Res* 142(2): 397-405 (1982).
- S22 Straume, T. Tritium risk assessment. *Health Phys* 65(6): 673-682 (1993).
- S23 Straume, T. and A.L. Carsten. Tritium radiobiology and relative biological effectiveness. *Health Phys* 65(6): 657-672 (1993).
- S24 Streffer, C., D. van Beuningen and S. Elias. Comparative effects of tritiated water and thymidine on the preimplanted mouse embryo in vitro. *Curr Top Radiat Res Q* 12(1-4): 182-193 (1978).
- S25 Sun, X.Z., M. Inouye, H. Yamamura et al. Effects of prenatal treatment with tritiated water on the developing brain in mouse. *Int J Radiat Biol* 71(3): 309-313 (1997).
- T1 Takeda, H. and Y. Kasida. Biological behavior of tritium after administration of tritiated water in the rat. *J Radiat Res* 20(2): 174-185 (1979).
- T2 Takeda, H. Comparative metabolism of tritium in rat after single ingestion of some tritiated organic compounds versus tritiated water. *J Radiat Res* 23(3): 345-357 (1982).
- T3 Takeda, H., K. Arai and T. Iwakura. Comparison of tritium metabolism in rat following single or continuous ingestion of tritium labeled wheat versus tritiated water. *J Radiat Res* 26(1): 130-139 (1985).
- T4 Takeda, H. Incorporation and distribution of tritium in rats after chronic exposure to various tritiated compounds. *Int J Radiat Biol* 59(3): 843-853 (1991).
- T5 Takeda, H., Y. Nishimura and J. Inaba. Transfer of tritium to prenatal and neonatal rats from their mothers exposed to tritiated compounds. *Radiat Prot Dosim* 53(1-4): 281-284 (1994).
- T6 Takeda, H., H.M. Lu, K. Miyamoto et al. Comparative biokinetics of tritium in rats during continuous ingestion of tritiated water and tritium-labeled food. *Int J Radiat Biol* 77(3): 375-381 (2001).
- T7 Tanaka, K., S. Sawada and N. Kamada. Relative biological effectiveness and dose rate effect of tritiated water on chromosomes in human lymphocytes and bone marrow cells. *Mutat Res* 323(1-2): 53-61 (1994).
- T8 Taylor, D.M., J.P. Moroni, J.O. Snihs et al. The metabolism of 3H and 14C with special reference to radiation protection. *Radiat Prot Dosim* 30(2): 87-93 (1990).
- T9 Taylor, D.M. A biokinetic model for predicting the retention of 3H in the human body after intakes of tritiated water. *Radiat Prot Dosim* 105(1-4): 225-228 (2003).
- T10 Taylor, D.M. Radiation doses from some [3H]-labelled organic compounds following ingestion. *Radiat Prot Dosim* 128(3): 299-308 (2008).

- T11 Thierry-Chef, I., M. Marshall, J.J. Fix et al. The 15-Country Collaborative Study of Cancer Risk among Radiation Workers in the Nuclear Industry: study of errors in dosimetry. *Radiat Res* 167(4): 380-395 (2007).
- T12 Thierry-Chef, I., D.B. Richardson, R.D. Daniels et al. Dose estimation for a study of nuclear workers in France, the United Kingdom and the United States of America: methods for the International Nuclear Workers Study (INWORKS). *Radiat Res* 183(6): 632-642 (2015).
- T13 Trivedi, A. Skin-contact exposure to tritium-gas-contaminated stainless-steel surfaces. *Health Phys* 65(5): 514-522 (1993).
- T14 Trivedi, A., D. Galeriu and R.B. Richardson. Dose contribution from metabolized organically bound tritium after acute tritiated water intakes in humans. *Health Phys* 73(4): 579-586 (1997).
- T15 Trivedi, A. and N.E. Gentner. Dosimetry and health effects of tritium in the CANDU business. Atomic Energy of Canada Limited, Canada, 1999.
- T16 Trivedi, A., D. Galeriu and E.S. Lamothe. Dose contribution from metabolized organically bound tritium after chronic tritiated water intakes in humans. *Health Phys* 78(1): 2-7 (2000).
- T17 Tuschl, H., F. Steger and R. Kovac. Occupational exposure and its effect on some immune parameters. *Health Phys* 68(1): 59-66 (1995).
- U1 Ueno, A.M., I. Furuno-Fukushi and H. Matsudaira. Induction of cell killing, micronuclei, and mutation to 6-thioguanine resistance after exposure to low-dose-rate gamma rays and tritiated water in cultured mammalian cells (L5178Y). *Radiat Res* 91(3): 447-456 (1982).
- U2 Ujeno, Y. Relative biological effectiveness (RBE) of tritium beta rays in relation to dose rate. *Health Phys* 45(3): 789-791 (1983).
- U3 Ujeno, Y., K. Yamamoto, T. Aoki et al. Tritium content in tissue free water of Japanese bodies. *Radiat Prot Dosim* 16 (1-2): 181-183 (1986).
- U4 Umata, T., N. Kunugita and T. Norimura. A comparison of the mutagenic and apoptotic effects of tritiated water and acute or chronic caesium-137 gamma exposure on spleen T lymphocytes on normal and p53-deficient mice. *Int J Radiat Biol* 85(12): 1082-1088 (2009).
- U5 UNSCEAR. Ionizing Radiation: Sources and Biological Effects. UNSCEAR 1982 Report. United Nations Scientific Committee on the Effects of Atomic Radiation, 1982 Report to the General Assembly, with annexes. United Nations sales publication E.82.IX.8. United Nations, New York, 1982.
- U6 UNSCEAR. Sources, Effects and Risks of Ionizing Radiation. UNSCEAR 1988 Report. United Nations Scientific Committee on the Effects of Atomic Radiation, 1988 Report to the General Assembly, with annexes. United Nations sales publication E.88.IX.7. United Nations, New York, 1988.
- U7 UNSCEAR. Sources and Effects of Ionizing Radiation. UNSCEAR 1993 Report. United Nations Scientific Committee on the Effects of Atomic Radiation, 1993 Report to the General Assembly, with scientific annexes. United Nations sales publication E.94.IX.2. United Nations, New York, 1993.
- U8 UNSCEAR. Sources and Effects of Ionizing Radiation. Volume II: Effects. UNSCEAR 2000 Report. United Nations Scientific Committee on the Effects of Atomic Radiation, 2000 Report to the General Assembly, with scientific annexes. United Nations sales publication E.00.IX.4. United Nations, New York, 2000.
- U9 UNSCEAR. Sources and Effects of Ionizing Radiation. Volume I: Sources. UNSCEAR 2000 Report. United Nations Scientific Committee on the Effects of Atomic Radiation, 2000 Report to the General Assembly, with scientific annexes. United Nations sales publication E.00.IX.3. United Nations, New York, 2000.

- U10 UNSCEAR. Hereditary Effects of Radiation. UNSCEAR 2001 Report. United Nations Scientific Committee on the Effects of Atomic Radiation, 2001 Report to the General Assembly, with scientific annex. United Nations sales publication E.01.IX.2. United Nations, New York, 2001.
- U11 UNSCEAR. Effects of Ionizing Radiation. Volume I: Report to the General Assembly, Scientific Annexes A and B. UNSCEAR 2006 Report. United Nations Scientific Committee on the Effects of Atomic Radiation. United Nations sales publication E.08.IX.6. United Nations, New York, 2008.
- U12 UNSCEAR. Effects of Ionizing Radiation. Volume II: Scientific Annexes C, D and E. UNSCEAR 2006 Report. United Nations Scientific Committee on the Effects of Atomic Radiation. United Nations sales publication E.09.IX.5. United Nations, New York, 2009.
- V1 Virsik, R.P., C. Schafer, D. Harder et al. Chromosome aberrations induced in human lymphocytes by ultrasoft Al (K) and C (K) X-rays. *Int J Radiat Biol Relat Stud Phys Chem Med* 38(5): 545-557 (1980).
- V2 Vrijheid, M., E. Cardis, M. Blettner et al. The 15-Country Collaborative Study of Cancer Risk Among Radiation Workers in the Nuclear Industry: design, epidemiological methods and descriptive results. *Radiat Res* 167(4): 361-379 (2007).
- V3 Vulpis, N. The induction of chromosome aberrations in human lymphocytes by in vitro irradiation with beta particles from tritiated water. *Radiat Res* 97(3): 511-518 (1984).
- W1 Wakeford, R., S.C. Darby and M.F. Murphy. Temporal trends in childhood leukaemia incidence following exposure to radioactive fallout from atmospheric nuclear weapons testing. *Radiat Environ Biophys* 49(2): 213-227 (2010).
- W2 Wakeford, R. The risk of leukaemia in young children from exposure to tritium and carbon-14 in the discharges of German nuclear power stations and in the fallout from atmospheric nuclear weapons testing. *Radiat Environ Biophys* 53(2): 365-379 (2014).
- W3 Wang, B. and X.Y. Zhou. Effects of prenatal exposure to low-dose beta radiation from tritiated water on the neurobehavior of mice. *J Radiat Res* 36(2): 103-111 (1995).
- W4 Wang, B., K. Watanabe, T. Yamada et al. Effects of beta radiation from organically bound tritium on cultured mouse embryonic mid brain cells. *Health Phys* 71(6): 915-921 (1996).
- W5 Wanigaratne, S., E. Holowaty, H. Jiang et al. Estimating cancer risk in relation to tritium exposure from routine operation of a nuclear-generating station in Pickering, Ontario. *Chronic Dis Inj Can* 33(4): 247-256 (2013).
- W6 Wawerna, J.C. Biological implications of the application of tritiated luminous compounds. pp.356-363 in: *Tritium* (A.A. Moghissi and M.W. Carter, eds.). Messenger Graphics, Phoenix, 1973.
- W7 WHO. Guidelines for drinking-water quality. Fourth edition. World Health Organization, Geneva, 2011.
- W8 Wood, M.J., R.G. McElroy, R.A. Surette et al. Tritium sampling and measurement. *Health Phys* 65(6): 610-627 (1993).
- W9 Wylie, K.F., W.A. Bigler and G.R. Grove. Biological half-life of tritium. *Health Phys* 9(9): 911-914 (1963).
- Y1 Yamada, T., O. Yukawa, K. Asami et al. Effect of chronic HTO beta or <sup>60</sup>Co gamma radiation on preimplantation mouse development in vitro. *Radiat Res* 92(2): 359-369 (1982).
- Y2 Yamamoto, O., K. Yokoro, T. Seyama et al. HTO oral administration in mice. I: Threshold dose rate for haematopoietic death. *Int J Radiat Biol* 57(3): 543-549 (1990).

- Y3 Yamamoto, O., T. Seyama, T. Jo et al. Oral administration of tritiated water (HTO) in mouse. II. Tumour development. *Int J Radiat Biol* 68(1): 47-54 (1995).
- Y4 Yamamoto, O., T. Seyama, H. Itoh et al. Oral administration of tritiated water (HTO) in mouse. III: Low dose-rate irradiation and threshold dose-rate for radiation risk. *Int J Radiat Biol* 73(5): 535-541 (1998).
- Y5 Yin, H., D. Bhattacharjee, G. Roy et al. Tumorigenesis in infant C3H/HeN mice exposed to tritiated water (HTO). *J Radiat Res* 43(4): 345-351 (2002).
- Y6 Yokoro, K., O. Yamamoto, T. Seyama et al. Acute and chronic effects of tritiated water in mice with special reference to its carcinogenicity: an interim report. *Radiat Prot Dosim* 16(1-2): 165-168 (1986).
- Y7 Yoon, S., W.H. Ha and S.S. Lee. Tritium analysis of urine samples from the general Korean public. *Appl Radiat Isot* 81: 276-278 (2013).
- Z1 Zablotska, L.B., J.P. Ashmore and G.R. Howe. Analysis of mortality among Canadian nuclear power industry workers after chronic low-dose exposure to ionizing radiation. *Radiat Res* 161(6): 633-641 (2004).
- Z2 Zablotska, L.B., R.S. Lane and P.A. Thompson. A reanalysis of cancer mortality in Canadian nuclear workers (1956-1994) based on revised exposure and cohort data. *Br J Cancer* 110(1): 214-223 (2014).
- Z3 Zamenhof, S. and E. van Marthens. The effects of chronic ingestion of tritiated water on prenatal brain development. *Radiat Res* 77(1): 117-127 (1979).
- Z4 Zamenhof, S. and E. van Marthens. The effects of pre- and postnatal exposure to tritiated water for five generations on postnatal brain development. *Radiat Res* 85(2): 292-301 (1981).
- Z5 Zhou, X.Y., J.C. Dong, X.S. Geng et al. Tritium beta-ray and <sup>60</sup>CO gamma-ray caused dominant lethal mutation in mice. *Chin Med J* 99(5): 420-423 (1986).
- Z6 Zhou, X.Y., J.C. Dong, S.Y. Zhou et al. Experimental study on relative biological effectiveness of tritium and risk estimates of genetic damage. *Chin Med J* 102(11): 872-878 (1989).
- Z7 Zhou, Y. and Y.S. Cheng. Dose assessment for inhaling hafnium particles based on laboratory rats study. *Health Phys* 84(4): 469-476 (2003).
- Z8 Zhou, Y. and Y.S. Cheng. Dosimetry of metal tritide particles as evaluated by the ICRP 66 model and a biokinetic model from laboratory rats. *Health Phys* 86(2): 155-160 (2004).
- Z9 Zhou, Y., Y.S. Cheng and Y. Wang. Dissolution rate and biokinetic model of zirconium tritide particles in rat lungs. *Health Phys* 98(5): 672-682 (2010).







ANNEX D

BIOLOGICAL EFFECTS OF SELECTED INTERNAL  
EMITTERS—URANIUM



## CONTENTS

I. INTRODUCTION .....	365
II. SOURCES AND LEVELS .....	367
A. Natural sources .....	367
B. Artificial sources .....	374
III. PHYSICAL, RADIOLOGICAL AND CHEMICAL CHARACTERISTICS .....	378
A. Physical and radiological characteristics.....	378
B. Chemical characteristics.....	379
IV. HUMAN EXPOSURE .....	380
A. Exposure of members of the public.....	380
B. Occupational exposure .....	382
C. Measurement of uranium .....	382
V. BIODYNAMICS.....	383
A. Inhalation.....	384
B. Ingestion .....	385
C. Absorption .....	386
D. Systemic distribution, retention and excretion .....	386
E. Materno-fetal transfer .....	387
VI. DOSIMETRY .....	388
VII. BIOLOGICAL EFFECTS.....	390
A. Chemical versus radiological toxicity .....	390
B. Kidneys .....	391
C. Bone.....	397
D. Lungs.....	399
E. Liver .....	400
F. Brain.....	401
G. Reproduction and development .....	405
H. Other organs .....	408
I. Relative biological effectiveness.....	414
J. Lethal effects .....	414

VIII. EPIDEMIOLOGICAL STUDIES.....	416
A. Studies of occupational exposure.....	416
B. Studies of Gulf War veterans .....	433
C. Studies of environmental exposure.....	434
IX. RESEARCH NEEDS.....	437
X. GENERAL CONCLUSION .....	438
XI. ACKNOWLEDGEMENTS .....	439
APPENDIX A. TABLES SUMMARIZING URANIUM LEVELS IN WATER, STUDIES OF OCCUPATIONAL AND ENVIRONMENTAL EXPOSURE TO URANIUM.....	441
REFERENCES.....	467

## I. INTRODUCTION

1. This annex provides a review of the scientific literature on characteristics of uranium, its biokinetics and dosimetry within the human body for various physical and chemical forms and routes of intake into the body, radiobiological and toxicological effects of exposure to uranium, and epidemiological studies of nuclear workers and the public who have been exposed to uranium.

2. Uranium was discovered by Martin Heinrich Klaproth in 1789 and its radioactive properties by Antoine Henri Becquerel in 1896. Uranium, element 92 in the periodic table, is present naturally in all rock and soil. Levels of uranium content in soil depend on local geology and range widely from a few mg/kg up to levels of several per cent in ore bodies. The Committee in its UNSCEAR 2008 Report [U10] reported a median activity concentration of around 30 Bq/kg (1.2 mg/kg) for uranium in rock and soil. Uranium is released to the environment through natural events such as forest fires and volcanoes and released from rock and soil through natural processes. It is distributed through mechanisms such as leaching to ground and surface water and through wind erosion of soil. In turn, uranium in water, soil and air is taken up by plants and animals. People may be exposed to uranium by inhalation of airborne particulates, through skin uptake and through ingestion of uranium in food and water.

3. There are three naturally-occurring, alpha-particle emitting, isotopes of uranium:  $^{238}\text{U}$ ,  $^{234}\text{U}$  and  $^{235}\text{U}$ . Two of these,  $^{238}\text{U}$  and  $^{235}\text{U}$ , with radioactive half-lives of  $4.47 \times 10^9$  and  $7.04 \times 10^8$  years respectively, are the parents of radioactive decay chains that are major contributors to the background radiation exposure of the human population. Uranium-238 supports 14 decay products. The isotope  $^{234}\text{U}$ , with a half-life of  $2.45 \times 10^5$  years, is a member of the  $^{238}\text{U}$  decay chain. In natural uranium,  $^{238}\text{U}$  is the most abundant isotope in terms of mass (99.2742%), while  $^{234}\text{U}$  and  $^{235}\text{U}$  constitute only 0.0054% and 0.7204%, respectively [N8, S15]. Figure I shows a simplified radioactive decay chains for  $^{238}\text{U}$ . Other isotopes, such as  $^{232}\text{U}$ , may be produced in thorium breeder reactors. Further,  $^{236}\text{U}$  uranium, with a half-life  $2.35 \times 10^7$  years, is present in spent nuclear fuel and in reprocessed uranium [W24], and occurs naturally as a very small component of natural uranium ( $<10^{-11}\%$  by mass).

4. Both  $^{238}\text{U}$  and  $^{234}\text{U}$ , when in secular equilibrium, contribute 48.9% of the total alpha particle activity of natural uranium, while  $^{235}\text{U}$  contributes 2.2%. Some nuclear reactors require fuel that is enriched to the fissionable isotope  $^{235}\text{U}$ . Current technologies for enriching natural uranium are gaseous diffusion and centrifugation. Enrichment increases the proportion of  $^{235}\text{U}$  from its natural levels (0.72%) to 2–5%, depending on the design requirements of nuclear power reactors. In addition, higher enrichment levels ( $>90\%$  of  $^{235}\text{U}$ ) are achieved for use in weapons. The term depleted uranium (DU) refers to isotopic mixtures that contain a lower percentage of  $^{235}\text{U}$  than is present in naturally occurring uranium. It is recovered as a by-product of the enrichment process. The proportion of  $^{235}\text{U}$  in DU is between 0.2 and 0.3%. Reprocessed uranium (especially from earlier military reprocessing) may also be contaminated with traces of fission products and transuranic elements [W24].

5. Uranium compounds exhibit differences in their chemical and physical properties and, as a result, also differ in their toxicological properties. For example, uranium compounds vary widely in their solubility and this can result in differences in bioavailability following intake (via inhalation or ingestion) into the body [A31, L9, S37, U16]. The biological and health effects of uranium are due to its chemical and radiological toxicity. In general, this toxicity, as demonstrated in animal studies, is caused by chemical rather than radiological components, excepting that effects induced by the isotopes of higher specific activity and by enriched uranium are more probably due to radiation exposure.

6. Since 1949, many animal studies have indicated that the toxicity of uranium is due mainly to chemical damage to the kidneys [A25]. Other systems or organs may also be affected by exposure to uranium, such as the skeleton [A26], the lungs [L18], the gonads [A19] and the liver [P6].

Figure I. Radioactive decay chain for  $^{238}\text{U}$  [I17]

Half-life is expressed in a = year; d = day; h = hours; m = minutes; s = seconds

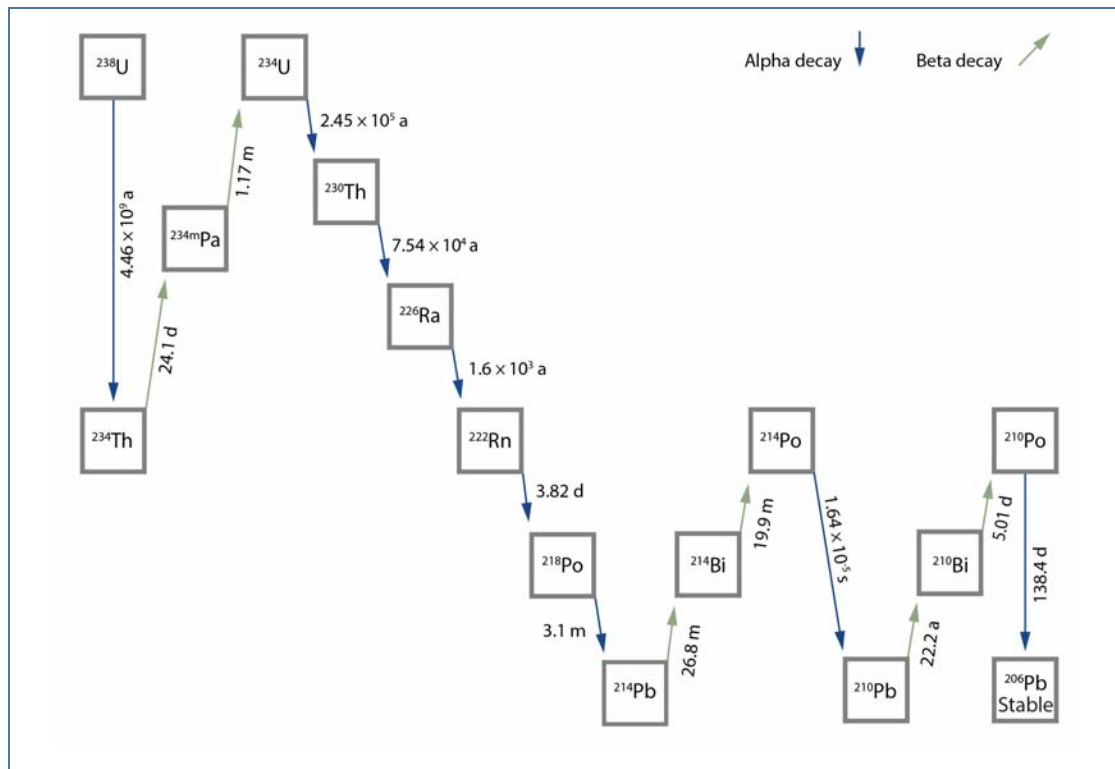

7. Uranium concentrations in environmental media may be measured in terms of radioactivity (measured in Bq/L, e.g. by alpha spectrometry) or mass (measured in  $\mu\text{g/L}$ , e.g. by high-resolution inductively coupled plasma mass spectrometry). Consequently, data on uranium levels in soil, air, water and food are indicated in Bq/L and in  $\mu\text{g/L}$ .

8. A general concept is the relation between radioactivity and mass. As mentioned above, the *activity* of each member of a chain headed by a parent radionuclide would be the same under conditions of secular equilibrium, but the *mass* of each member of the chain would be quite different. The relationship between activity,  $A$ , and mass,  $M$ , of a radionuclide is given by:

$$A = \frac{A_0 \times \lambda}{AW} \times M = \frac{A_0}{AW} \times \frac{\ln(2)}{T_{1/2}} \times M$$

where

$A$	=	activity of a radionuclide, Bq;
$A_0$	=	Avogadro's constant, $6.023 \times 10^{23}$ atoms/mole;
$AW$	=	atomic weight of the radionuclide, kg/mole;
$\lambda$	=	decay constant, dis/(atom s);
$T_{1/2}$	=	half-life of the radionuclide, s;
$M$	=	mass of the radionuclide, kg.

For natural uranium, the activity is 25,400 Bq/g (table 1). However, as shown in table 1, the natural relative abundance of  $^{234}\text{U}$ ,  $^{235}\text{U}$  and  $^{238}\text{U}$  can be expressed in terms of either numbers of atoms or weight, giving slightly different values [K3, M31, M32].

Table 1. Mass activities of the three natural isotopes of uranium [K3]

Natural uranium	Relative abundance	
	atoms% (wt%)	mBq/ $\mu\text{g U}$
$^{238}\text{U}$	99.274 (99.284)	12.40
$^{235}\text{U}$	0.720 (0.711)	0.60
$^{234}\text{U}$	0.0054 (0.0053)	12.40

## II. SOURCES AND LEVELS

### A. Natural sources

#### 1. Levels in soil

9. Naturally occurring radionuclides in the environment affect the levels of background radiation encountered at different locations around the world [N2, U8]. As mentioned by Cuney [C38], three types of deposits contain more than three quarters of the worldwide uranium resources: unconformity-related deposits, iron oxide–copper–gold (IOCG) deposits, and sandstone-hosted deposits [L10].

10. The concentration of uranium in soil varies with location and local geology. Its concentration is relatively low in basic rock, such as basalt, and higher in acid rock, such as the sedimentary rock saturated with silica. The uranium content of granites is higher still [U10]. For example, the nominal activity concentration of uranium in soil is about 15 Bq/kg of  $^{238}\text{U}$  (1.2 mg/kg) with a typical activity range of 10–50 Bq/kg (0.4 to 2 mg/kg) [N2, U10]. Much higher concentrations are found in uranium mining areas such as the Northern Saskatchewan in Canada, the Colorado Plateau and central Florida where phosphate is mined. The uranium content of phosphate rock used for phosphate fertilizers ranges from about 50 to 2,400 Bq/kg of  $^{238}\text{U}$  (4–190 mg/kg) [A31, N2, R20, U8]. One of the highest activity concentrations worldwide is localized in the region of Recife in Brazil, with sedimentary rock that contains 30–500 mg/kg with an average of 150 mg/kg (1,860 (range 372–6,200 Bq/kg of  $^{238}\text{U}$ )) [S18]. However, since uranium in soil may be more or less tightly bound depending on soil characteristics, the uranium speciation in soil has an impact on bioaccessibility in the gut.

#### 2. Levels in air

11. Soil particles containing uranium may be transferred into the atmosphere through natural mechanisms. The natural uranium concentration in air is typically very low, varying from location to location according to local ground sources [H19]. Airborne uranium can deposit on soil, plants and open water as dry or wet deposition [A31].

12. Golchert et al. [G16] measured airborne concentrations of  $^{238}\text{U}$  of around  $0.3 \mu\text{Bq}/\text{m}^3$  at a site near the Argonne National Laboratory (Illinois, United States). Average levels of natural uranium in ambient air have been reported to be  $0.25 \mu\text{Bq}/\text{m}^3$  of  $^{238}\text{U}$  ( $0.02 \text{ ng}/\text{m}^3$ ) in Tokyo [H19]. Tracy and Prantl [T17] found the average concentration of  $^{238}\text{U}$  in air in a southern Ontario rural environment to be about  $1.25 \mu\text{Bq}/\text{m}^3$  ( $0.1 \text{ ng}/\text{m}^3$ ), on the basis of measurements of  $^{226}\text{Ra}$  in dust and an assumption of equilibrium between  $^{238}\text{U}$  and  $^{226}\text{Ra}$ . Taken together, these different values indicate an average uranium level in air of around  $1 \mu\text{Bq}/\text{m}^3$ .

13. The World Health Organization (WHO) [W14] estimates that an adult of average size inhales  $20 \text{ m}^3$  of air per day with a nominal natural uranium concentration of  $0.6 \mu\text{Bq}/\text{m}^3$  of  $^{238}\text{U}$  ( $0.05 \text{ ng}/\text{m}^3$ ), corresponding to  $12.4 \mu\text{Bq}$  ( $1 \text{ ng}$ ) of  $^{238}\text{U}$ . These values lead to a calculated annual intake through inhalation by adults of approximately  $0.0045 \text{ Bq}$  of  $^{238}\text{U}$ . For comparison, tobacco smoke (from two packages of cigarettes per day) contributes to  $0.11 \text{ Bq}$  of  $^{238}\text{U}$  (corresponding to  $9 \mu\text{g}$ ) of inhaled natural uranium per year [L49].

### 3. Levels in water

14. As long as uranium is inside undisturbed crystalline rock in secular equilibrium with its progeny, the ratio of  $^{234}\text{U}$  to  $^{238}\text{U}$  is expected to be one. Nevertheless, disequilibrium can be observed when rock is disturbed by chemical or physical processes involving water. As a result, water from any source may contain  $^{234}\text{U}/^{238}\text{U}$  ratios greater than unity because of the greater mobility and increased availability of  $^{234}\text{U}$ , generally due to a reducing environment [D1]. Two isotopes in the decay series,  $^{234}\text{Th}$  and  $^{234\text{m}}\text{Pa}$ , separate the two uranium isotopes and their different solubilities in the source rock, permitting  $^{234}\text{U}$  to be released preferentially and leading to variations in the ratio  $^{234}\text{U}/^{238}\text{U}$  [O9]. In addition, the total uranium activity present in water may influence the  $^{234}\text{U}/^{238}\text{U}$  ratio. Indeed, Ortega et al. found that ~80% of samples with a high ratio of disequilibrium ( $>1.6$ ) were linked to the lowest uranium activities  $<50 \text{ mBq}/\text{L}$ , when the samples with a low activity ratio ( $<1.5$ ) corresponded to samples with high concentrations of uranium ( $>200 \text{ mBq}/\text{L}$ ) [O8].

15. Uranium is present in different water sources (surface water, groundwater and drilled water) at variable levels [W16]. In oxygenated surface water, uranium levels were found at around  $0.02$  to  $6 \mu\text{g}/\text{L}$  ( $0.25$ – $76 \text{ mBq}/\text{L}$  of  $^{238}\text{U}$ ). In sea water, its average content is  $3.3 \mu\text{g}/\text{L}$  ( $42 \text{ mBq}/\text{L}$  of  $^{238}\text{U}$ ), often bound by ligands or associated with suspended particles [B42]. Natural uranium levels were found to be higher in Precambrian rock aquifers (average,  $115.6 \mu\text{g}/\text{L}$  ( $1.45 \text{ Bq}/\text{L}$  of  $^{238}\text{U}$ )) than in Palaeozoic sedimentary rock aquifers (average,  $3.5 \mu\text{g}/\text{L}$  ( $0.045 \text{ Bq}/\text{L}$  of  $^{238}\text{U}$ )). Cothorn and Lappenbusch [C34] reviewed the available data on the occurrence of uranium in surface and groundwater supplies in the United States and reported that surface water samples derived from about 35,000 sources had an average uranium concentration of  $18 \text{ mBq}/\text{L}$  of  $^{238}\text{U}$  ( $1.45 \mu\text{g}/\text{L}$ ) (range from  $0.18$  to about  $12,500 \text{ mBq}/\text{L}$  of  $^{238}\text{U}$  ( $0.014$ – $982 \mu\text{g}/\text{L}$ )) and that about 55,000 samples of groundwater supplies had an average uranium concentration of  $55 \text{ mBq}/\text{L}$  of  $^{238}\text{U}$  ( $4.4 \mu\text{g}/\text{L}$ ) (range  $-0.018$ – $12,000 \text{ mBq}/\text{L}$  of  $^{238}\text{U}$  ( $0.0014$ – $942 \mu\text{g}/\text{L}$ )).

16. The WHO indicated values for uranium levels in water generally less than  $12.4 \text{ mBq}/\text{L}$  of  $^{238}\text{U}$  ( $<1 \mu\text{g}/\text{L}$ ) [W15, W18]. The Agency for Toxic Substances and Disease Registry (ATSDR) reported an average concentration of  $14.4 \text{ mBq}/\text{L}$  of  $^{238}\text{U}$  ( $1.16 \mu\text{g}/\text{L}$ ) [A31]. This was much higher than the previously reported value by the Committee in its UNSCEAR 1977 Report  $0.54 \text{ mBq}/\text{L}$  of  $^{238}\text{U}$  ( $0.044 \mu\text{g}/\text{L}$ ) [U7]. Thus, it might be more appropriate to report median rather than mean values because of the large variation of uranium concentration in water. The Committee reported a variation of natural uranium concentrations measured in drinking water samples in 16 countries of about eight



orders of magnitude [U10]. A global overview of uranium concentration ( $\mu\text{g/L}$ ) and activity ( $\text{mBq/L}$ ) is given in appendix A, in table A1 for the values measured in groundwater, in table A2 for the values measured in surface water, in table A3 for the values measured in public water supplies and in table A4 for the values measured in bottled mineral water.

17. In Canada, different surveys aimed to measure uranium levels in drinking water in different provinces. The mean natural uranium concentration in surface water and groundwater (some treated) supplies was about  $50 \text{ mBq/L}$  of  $^{238}\text{U}$  ( $4 \mu\text{g/L}$ ) in southern-central British Columbia [P32],  $124 \text{ mBq/L}$  of  $^{238}\text{U}$  ( $10 \mu\text{g/L}$ ) in south-eastern Manitoba [B21],  $65 \text{ mBq/L}$  of  $^{238}\text{U}$  ( $5.2 \mu\text{g/L}$ ) in the Kitigan Zibi First Nation community in Quebec [M58], and  $5 \text{ mBq/L}$  of  $^{238}\text{U}$  ( $0.40 \mu\text{g/L}$ ) in Ontario [O3]. In summary, the analysis of the different values measured in these surveys indicates that mean uranium levels in drinking water were extremely variable in the different Canadian counties/provinces, from 5 to  $750 \text{ mBq/L}$  of  $^{238}\text{U}$  ( $0.4\text{--}58.3 \mu\text{g/L}$ ), including great internal variations depending on the precise location. Furthermore, behind these average uranium levels in drinking water, more extreme values were measured in some Canadian provinces or some counties in the United States as indicated in appendix A, table A1. In fact, natural uranium concentrations as high as  $8,680 \text{ mBq/L}$  of  $^{238}\text{U}$  ( $700 \mu\text{g/L}$ ) were found in private groundwater supplies [M64, M65]. A value of  $25,048 \text{ mBq/L}$  of  $^{238}\text{U}$  ( $2,020 \mu\text{g/L}$ ) was measured in groundwater in south-eastern Manitoba [B21].

18. Concerning water in the United States, official reports indicated an average natural uranium concentration of  $31.6 \text{ mBq/L}$  of  $^{238}\text{U}$  ( $2.55 \mu\text{g/L}$ ) in drinking water from 978 sites in the 1980s [U14]. These values are higher than those mentioned in a study by Fisenne et al. with mean activity of natural uranium in drinking water in New York City ranging from  $0.62$  to  $1.25 \text{ mBq/L}$  of  $^{238}\text{U}$  ( $0.05$  to  $0.09 \mu\text{g/L}$ ) [F5]. In this study, New York city tap water had  $^{234}\text{U}$ ,  $^{235}\text{U}$  and  $^{238}\text{U}$  activities of  $1.04\pm 0.19$ ,  $0.035\pm 0.010$  and  $0.87\pm 0.18 \text{ mBq/L}$ , respectively [F5]. Maximum values were measured in Connecticut  $86.472 \text{ mBq/L}$  of  $^{238}\text{U}$  ( $7,780 \mu\text{g/L}$ ). As for Canada, differences may relate to geographical variations and local geology (appendix A, table A1).

19. In Finland, national and local surveys of uranium content in water distributed by Finnish waterworks have been conducted. The median value was of  $1.9 \text{ mBq/L}$  of  $^{238}\text{U}$  ( $0.15 \mu\text{g/L}$ ) [T22] (appendix A, table A1). An extreme value of  $114,100 \text{ mBq/L}$  of  $^{238}\text{U}$  ( $9,200 \mu\text{g/L}$ ) was measured in the South of Finland [M66]. It is noteworthy that although the uranium concentrations in Finnish wells drilled in bedrock are among the highest in the world [K26, M66, M67, P28], the uranium concentration in water distributed by the waterworks is generally low [M67, T22].

20. In France, periodic reports address the levels of the radiological quality of drinking water [I21]. Measurements performed during 2008 and 2009 indicate that  $^{226}\text{Ra}$  and uranium isotopes constitute the main contributors to a total alpha activity above  $0.1 \text{ Bq/L}$ ; in this case, the mean value of uranium concentration was  $2.22 \mu\text{g/L}$  ( $27.5 \text{ mBq/L}$  of  $^{238}\text{U}$ ) with a range from  $0.14$  to  $114 \mu\text{g/L}$  ( $1.8\text{--}1,450 \text{ mBq/L}$  of  $^{238}\text{U}$ ) [I21].

21. Activity concentrations of natural radionuclides in soil, food, natural and drinking water were also measured in China [P2]. However, measurements of uranium were not reported for food and drinking water. Except for salt water lakes that presented higher uranium levels ( $22 \mu\text{g/L}$  or  $272.5 \text{ mBq/L}$  of  $^{238}\text{U}$ ), the values for uranium in freshwater lakes, reservoirs, rivers, hot and cold springs, well water and sea water were similar ( $2.2 \mu\text{g/L}$  with a range from  $0.87$  to  $3.82$  ( $27.3 \text{ mBq/L}$  of  $^{238}\text{U}$  with a range from  $10.78$  to  $47.3 \text{ mBq/L}$  of  $^{238}\text{U}$ ).

22. The guidance levels of radionuclide concentration provided in the WHO Guidelines for Drinking-Water Quality are based on an individual dose criterion (IDC) of  $0.1 \text{ mSv}$  committed effective dose from one year's consumption of drinking water. They are expressed as activity concentration for a

given isotope (Bq/L) and were calculated by dividing the IDC of 0.1 mSv per year by the product of the isotope dose conversion factor (Sv/Bq) and an assumed water consumption of 2 L per day (i.e. 730 L per year). The guidance levels of radioactivity concentration for  $^{238}\text{U}$  and  $^{234}\text{U}$  have been rounded to 10 Bq/L and 1 Bq/L, respectively [W18].

23. Due to the fact that the uranium chemical toxicity is generally of greater importance than radiological effects, several national and international guidelines refer to concentrations of uranium in drinking water, as indicated in table 2. Guideline values (in mg/L or  $\mu\text{g/L}$ ) were derived from the total tolerable daily intake (TDI) expressed in mg/kg or  $\mu\text{g/kg}$  of body weight (e.g. 60 kg for an adult used by WHO), itself based on the no observed adverse effect level (NOAEL)<sup>1</sup> or lowest observed adverse effect level (LOAEL) for kidney toxicity, divided by an uncertainty factor of 100 (for intra- and interspecies variation), and taking the daily drinking water consumption into account (~2 litres) [W16].

Table 2. National and international guidelines for uranium content in drinking water

Only chemical aspects of uranium toxicity are addressed in these guidelines

<i>Organizations/countries</i>	<i>Uranium in drinking water (<math>\mu\text{g/L}</math>)</i>	<i>Reference</i>
Australia	17	[N5]
Bulgaria	60	[E2]
Canada	20	[H16]
Finland	100	[E2]
Germany	10	[B27]
Slovenia	6.8	[E2]
USA	30	[U17]
WHO	30	[W18]

24. The WHO chemical guideline value for uranium in drinking water significantly increased from 2  $\mu\text{g/L}$  in 1998 up to 15  $\mu\text{g/L}$  in 2004 and then to 30  $\mu\text{g/L}$  in 2011 [W18]. The current WHO chemical guideline of 30  $\mu\text{g/L}$  is still designated as provisional because of scientific uncertainties regarding uranium toxicity, notably with regard to possible carcinogenic effects of uranium [A17] and specific sensitivity of some groups, such as children or people with hypertension or osteoporosis [F15].

25. Tables A1–A4 in appendix A show that uranium concentrations may exceed guideline values in several countries, including those of water from public supplies. In a study of 476 Norwegian groundwater samples, 18% had natural uranium concentrations in excess of 20  $\mu\text{g/L}$  (0.25 Bq/L of  $^{238}\text{U}$ ) [F12]. Natural uranium concentrations in groundwater in excess of 20  $\mu\text{g/L}$  (0.25 Bq/L) have also been reported in parts of New Mexico, the United States [H5], central Australia [F9] and France [I21]. Some Finnish studies noted a median uranium concentration of 28  $\mu\text{g/L}$  (0.35 Bq/L of  $^{238}\text{U}$ ) and 285  $\mu\text{g/L}$  (3.5 Bq/L of  $^{238}\text{U}$ ) in drinking water [K26, P28], respectively. In Canada, one study also reported high levels of uranium concentration up to 845  $\mu\text{g/L}$  (10.5 Bq/L of  $^{238}\text{U}$ ) in private wells [Z8].

26. In a Canadian study, Zamora et al. [Z6] found that water contributed 31–98% of the total daily intake of uranium from food and water for individuals whose drinking water contained uranium at concentrations ranging from 2 to 780  $\mu\text{g/L}$  (25 to 10,000 mBq/L of  $^{238}\text{U}$ ). This was similar to values

<sup>1</sup> NOAEL: the greatest concentration or amount of a substance that causes no detectable adverse alteration in morphology, functional capacity, growth, or life span of the target organism under defined conditions of exposure [W13].

obtained in studies by the United States Environmental Protection Agency, which reported that uranium in drinking water contributed about 31% [U13, U14] of the total daily uranium intake.

27. In summary, uranium average levels in water worldwide are: 2 µg/L (15 mBq/L of <sup>238</sup>U) for groundwater (appendix A, table A1), 1 µg/L (12.4 mBq/L of <sup>238</sup>U) for surface water (appendix A, table A2), 1 µg/L (12.4 mBq/L of <sup>238</sup>U) for public water supplies (appendix A, table A3), 0.5 µg/L (6.5 mBq/L of <sup>238</sup>U) for bottled mineral water (appendix A, table A4) (for natural uranium of 25,400 Bq/g). These median values hide great variability, notably for groundwater (0.0005–7.780 µg/L (0.0063–96,472 mBq/L of <sup>238</sup>U)). However, overall only a small proportion of few drinking water samples (generally <3%) exceed the national or international guidelines. As expected, the values for uranium content in bottled mineral water are not so scattered.

#### 4. Levels in food

28. The measurement of the bioaccumulation of uranium in animals and plants shows that concentration factors are dependent on organism characteristics (e.g. species, life stage, physiology), exposure pathways, and the chemical and physical characteristics of the environment [G4, Q2]. Various publications have reported that the most available forms of uranium in plants were phosphate, carbonate, sulphate or citrate forms [L14, L15].

29. Most available data relate to transfer through plants from their roots and the direct contamination of aquatic organisms. Within plants, uranium concentrates mainly in the roots. Uranium found in meat and dairy products results from livestock feeding on plants and on food supplement made from natural phosphates and supplied to dairy cows. Ingestion of soil particles, either directly or through consumption of grass contaminated with soil, is likely to be a significant component of the total intake by livestock. Transfer parameters of natural uranium are known for the main meat-producing species (cattle, sheep and pigs) and also for cow's milk [I1]. They vary between  $3.9 \times 10^{-4}$  and  $7.5 \times 10^{-1}$  day/L in bovine meat and poultry, respectively.

30. Uranium has been detected in a variety of foodstuffs, with great variability. The <sup>238</sup>U activity has been estimated to be 100-fold higher in root vegetables than in fruit or leafy vegetables as shown, for example, by measurements for beets and tomatoes (100 vs. 1.13 mBq/kg, respectively) [I2]. A synopsis of the activity of <sup>238</sup>U measured by different authors in several types of foodstuffs is contained in the Committee's 1977 Report and in its 2000 Report [U7, U8]. Meat products have the lowest uranium activity (between 0.08 and 20 of <sup>238</sup>U mBq/kg). A recent report indicated activities of <sup>238</sup>U between 1 and 49 mBq/kg for meat products [R11].

31. An estimate of daily uranium ingestion of food was made in Japan for urban residents [K30]. Concentration of <sup>238</sup>U varied between  $9.9 \times 10^{-5}$  and 5.9 Bq/kg depending on food types: grain vinegar and boiled and dried hijiki (a brown sea vegetable), respectively. When prepared diets were analysed, the uranium concentrations observed were, on average, about four times higher than those seen in raw foodstuffs. Hamilton explained this to the possible addition of uranium in seasonings and to transfer from the cookware [H8]. It was unclear whether these dietary intakes included those from drinking water and it was emphasized that the latter had sometimes been found to be equal to that from the diet [H8]. Wrenn et al. have suggested that in regions where treated surface water was used for cooking and drinking, food appeared to be the major source of uranium intake [W26].

32. In aquatic animals (crustaceans, molluscs and fish), the bioconcentration factor from water is very low [I3]. Concentration factors for fish vary from 0.01 to 20. The values depend on the behaviour of the organisms (pelagic species accumulate approximately 10 times less than benthic species) and the

tissues considered (bone 200–8,000 and kidneys > liver and gills > muscles 1.5–24 > digestive system > gonads). A study was performed in Japan to determine uranium concentrations in marine organisms (soft tissues) [M15]. This study showed large differences in uranium levels depending on the marine species, with a minimum value of 0.077 µg/kg (0.97 mBq/kg of <sup>238</sup>U) measured in rockfish (kichiji) and a value of 5,040 µg/kg (63.8 Bq/kg of <sup>238</sup>U) found in octopus. The values reported by Belles et al. also indicated that fish and seafood showed the highest uranium concentrations (90 µg/kg, 1.1 Bq/kg of <sup>238</sup>U), followed by dairy products (40 µg/kg, 0.5 Bq/kg of <sup>238</sup>U) [B12].

33. The concentrations of uranium in fish are also dependent on uranium levels in water. The uranium concentrations in the muscle (dry weight) of fish caught in a Canadian lake receiving effluents from a uranium mill were 7–11 times higher than those from fish caught in uncontaminated lakes [S50]. Uranium mines and mills operating between the 1940s and the late 1970s have left behind legacy contamination due to historic mining and milling practices and incomplete site remediation during decommissioning. In Beaverlodge Lake, Northern Saskatchewan, Canada, elevated concentrations of uranium are still present with a mean concentration for the period 2013–2015 of approximately 135 µg/L (range 130–142) corresponding to 1.69 Bq/L of <sup>238</sup>U (range 1.63–1.78) [C2, C3, C4].

34. Human health risk assessments for environmental contaminants take soil ingestion rates into consideration. The value recommended by Richardson and Stantec Consulting Ltd. [R13] of 20–40 mg/d for children is based on mechanistic assessments made by Wilson et al. [W21] and Ozkaynak et al. [O10]. Another report suggested assessing health risk for children with the value of 100 mg of soil per day [U15]. However, uranium bound to soils is not completely bioavailable. Reported bioaccessibility (in vitro estimate of bioavailability) values are quite variable ranging from 21±12% in the gastric phase and 48±17% in the gastric and intestinal phase [J4] to less than 5% in the gastro-intestinal phase [T16].

35. The urinary concentrations of several metals, including uranium, were found to be higher than international reference values in a study of schoolchildren and working children in Lahore, Pakistan [S44]. The measured urinary concentrations of uranium corresponded well with uranium concentrations in drinking water.

36. A study of 19 categories of food was performed by Fisenne et al. [F5, F6]. Potatoes, meat, fresh fish and bakery products were found to contribute more than 70% of the average uranium intake (1.2 µg/d or 14.9 mBq/d of <sup>238</sup>U). Dietary levels of uranium in the United Kingdom were reported in a study of typical diets using both raw and prepared foodstuffs. Analysis of the raw foodstuffs indicated that 83% of the daily intake of uranium derived from starchy roots, vegetables and fruit, and cereals.

37. The Committee in its 1977 Report [U7] included a summary of <sup>238</sup>U concentrations in foodstuffs in France, Japan and the former Soviet Union along with the results given above for the United States and the United Kingdom. In areas with typical uranium concentrations in soils, the daily dietary intake fell within a relatively small range, ~0.9 to 1.5 µg natural uranium (11.5 to 19 mBq of <sup>238</sup>U). This range is consistent with values given in several publications calculated from the mass activity of natural uranium (25,400 Bq/g): 1.32 µg/day corresponding to 16.4 mBq/day of <sup>238</sup>U for typical diets of adults in New York City, Chicago and San Francisco in the United States [W11], 1.14 µg/day (14.5 mBq/day of <sup>238</sup>U) [K30] and 1.46 µg (18.6 mBq/day of <sup>238</sup>U) in different cities in Japan [N9]. In the United States, the average daily per capita intake of natural uranium in foodstuffs was estimated to range from about 1 to 33 µg (i.e. from about 12 mBq <sup>238</sup>U/day to 405 mBq <sup>238</sup>U/day) determined from excretion measurements [S26]. The values given by ATSDR indicated that the daily intake of uranium from food sources ranged from 0.9 to 1.5 µg/day [A31, W11]. Similar values were given for European countries [W15]: intakes ranged from 6 to 22 mBq/day of <sup>238</sup>U corresponding to 0.47 and 1.77 µg/day, respectively. This daily intake contributed to a body burden of around 50 µg (0.62 Bq of <sup>238</sup>U) in humans [F6].

38. The Codex Alimentarius gives guideline levels applied to radionuclides contained in food, destined for human consumption and traded internationally, which has been contaminated following a nuclear or radiological emergency [C29]. These guideline levels apply to food after reconstitution or as prepared for consumption, i.e. not to dried or concentrated foods, and are based on an intervention exemption level of 1 mSv in a year. A value of 100 Bq/kg is given for  $^{235}\text{U}$ . However, these guideline levels exclude radionuclides of natural origin such as  $^{238}\text{U}$ .

39. In summary, uranium is present in a variety of foodstuffs, with great variability. Potatoes, meat, fresh fish and bakery products were found to contribute more than 70% of the average uranium daily intake. The total daily intake in food was found to be around 1.5  $\mu\text{g}$  (18.6 mBq of  $^{238}\text{U}$ ), about twice that via drinking water, recognizing that levels in diet and drinking water can vary greatly.

## 5. Levels in milk

40. Some publications report uranium levels in milk, notably from cattle. The uranium concentrations measured in milk were in a wide range, from 0.012 to 0.41  $\mu\text{g/L}$  (0.15–5.2 mBq/L of  $^{238}\text{U}$ ), depending on the species and the technical methodology (table 3). A mean value of 0.26  $\mu\text{g/L}$  is given, corresponding to 3.3 mBq/L of  $^{238}\text{U}$  (range 0.001–1.20  $\mu\text{g/L}$ ; 0.012–15 mBq/L of  $^{238}\text{U}$ ), if the highest values of Santos et al. [S3] are excluded. This mean value is above the reference value of 1 mBq/L of  $^{238}\text{U}$  given in the Committee's UNSCEAR 2000 Report [U8]. Furthermore, transfer coefficients of uranium into milk are also available in the literature [A5, K1, T8, W9, W28] and presented for different species in table 4.

Table 3. Uranium content (mass and activity) in milk (animals)

Values are expressed in kg of fresh matter, the numbers in italics correspond to calculated data obtained from the mass activity of natural uranium of 25,400 Bq/g and from the relative proportion of  $^{238}\text{U}$  (12.4 mBq/ $\mu\text{g}$ ) in natural uranium of 48.3%

<i>[U] in <math>\mu\text{g/L}</math></i>	<i><math>^{238}\text{U}</math> in mBq/L</i>	<i>Reference</i>
0.14–0.24	1.74–2.98	[A14]
<i>1.20</i>	14.8	[S43]
0.10 (0.03–0.24)	1.24 (0.38–3.0)	[F16, M34]
<i>0.72±0.35</i>	8.9±4.3	[A5]
<i>0.001–0.01</i>	0.01–0.12	[R11]
<i>0.21±0.02</i>	2.56±0.25	[P19]
<i>0.25±0.06</i>	3.07±0.74	[P20]
<i>3.09 (0.18–9.6)</i>	38 (2.2–118)	[S3]

Table 4. Transfer coefficients of uranium into milk (animals)

n.i.: not indicated

Species	Transfer factor (d/L)	Range (d/L)	Reference
Cattle	$2.0 \times 10^{-4}$	$6.0 \times 10^{-5}$ – $6.0 \times 10^{-4}$	[T8]
Cow	$2.9 \times 10^{-3}$	$5.0 \times 10^{-4}$ – $6.1 \times 10^{-3}$	[K1]
Sheep and goat	$1.0 \times 10^{-3}$	$3.0 \times 10^{-4}$ – $3.0 \times 10^{-3}$	[T8]
Goat	$1.4 \times 10^{-3}$	n.i.	[K1]
Camel	$4.2 \times 10^{-3}$	$1.1 \times 10^{-3}$ – $1.5 \times 10^{-2}$	[A5]

## B. Artificial sources

41. The main application of uranium is for energy production and military use. Uranium-235 is naturally a fissile isotope. Uranium is used primarily in most nuclear power plants. Its utilization in most reactors requires enrichment of natural uranium containing 0.72% by weight of  $^{235}\text{U}$  to a  $^{235}\text{U}$  content of 2–5%. Weapons use high enriched uranium with over 90%  $^{235}\text{U}$ . Some research reactors and naval reactors also use high enriched uranium. Depleted uranium is used as a metal in kinetic energy penetrators and tank armour.

42. The nuclear fuel cycle leading to the production of electricity from uranium in nuclear power reactors includes mining, milling, conversion, enrichment, fabrication of nuclear fuel and reprocessing [G18]. Mining for the extraction of uranium involves both conventional open pit (where deposits are close to the surface) and underground mining (used for deeper deposits). Currently, most uranium mining worldwide uses the in situ leach mining process [S4]. The milling process produces a uranium oxide concentrate, named Yellowcake, which contains more than 80% uranium. This uranium oxide is then converted to uranium hexafluoride ( $\text{UF}_6$ ). It contains only natural uranium, which is enriched via one of the two major types of enrichment technologies, gaseous diffusion or gas centrifuge. The enriched uranium hexafluoride is then converted to uranium dioxide ( $\text{UO}_2$ ) powder and processed into ceramic pellets. Finally, these pellets are inserted into tubes of corrosion-resistant metal alloy, called fuel rods, which are grouped in fuel assemblies for the nuclear fuel core of a power reactor.

43. The uranium remaining after removal of the enriched fraction is DU, containing 0.3%  $^{235}\text{U}$  or less [B22, B26]. This uranium has various civilian applications, such as in counterweights or ballast in aircraft or counterweights for rudders and flaps [B22], for X-ray radiation shielding in medical equipment and also for containers for the transport of radioactive material. Moreover, DU has also been used in glassware, ceramics and dentistry.

44. In addition to exposure to natural uranium in the environment, anthropogenic activities have led to increasing uranium exposure for humans. For instance, uranium was found to leach into water from uranium-bearing glass items (maximum uranium in water,  $30 \mu\text{g/L}$  ( $0.38 \text{ Bq/L}$  of  $^{238}\text{U}$ ) and from ceramic-glazed items in which natural uranium is used as a colouring agent ( $300 \mu\text{g/L}$ ;  $3.7 \text{ Bq/L}$  of  $^{238}\text{U}$ ) [L6].

45. Uranium is present in water as a result of leaching from natural deposits and waste from the mining of uranium and other minerals, releases from the nuclear fuel cycle and the combustion of coal and other fuel [D22, E6, S26, T1]. Phosphate fertilizers, which may contain uranium at concentrations as high as  $150 \text{ mg/kg}$ , may also contribute to the uranium content of groundwater [S26].

46. Contamination of surface water and groundwater by effluents from uranium mining, milling, and production operations due to in situ leaching methods has been documented [A31, E1, H14, S50]. Table 5 shows some recent data. Except for some specific locations, i.e. at the pit, the values of uranium concentrations in surface water or groundwater are usually below the WHO guideline of 30 µg/L (372 mBq/L of <sup>238</sup>U).

47. Since the 1970s, DU is used for kinetic energy penetrators and tank armour, because of its pyrophoricity [B22]. The military applications of DU led to the significant release of this radionuclide into the environment during the conflicts in Iraq and Kuwait (321 tons of DU), in Bosnia-Herzegovina (3 tons of DU), and in the Kosovo (10 tons of DU). More details are given in reports by the United Nations Environment Programme (UNEP) and the National Defence Research Institute (NDRI) [H13, U3, U4, U5, U6].

48. The use of reprocessed DU in mixed oxide (MOX) fuels (constituted by 8–9% of plutonium and ~90% of DU) has been used as a recycling strategy by countries including France and Japan as an option to reduce the necessity for storage of spent fuel [R6].

49. In a study in Tajikistan, uranium concentrations were shown to vary from more than 1,600 µg/L (>20 Bq/L of <sup>238</sup>U) at the pit lake to 90 µg/L (1 mBq/L of <sup>238</sup>U) in tube supplies and 6.3 µg/L (80 mBq/L of <sup>238</sup>U) in drinking water from the neighbouring village [S28]. Another study documented uranium contamination of groundwater in Arizona, the United States after uranium mining [D13]. Approximately 20% of total uranium concentrations in the water samples exceeded the maximum concentration level for drinking water of 0.37 Bq/L of <sup>238</sup>U [U17]. In another study, the uranium content was measured in drinking water samples from locations near the uranium mining site at Jaduguda, India [P8] with uranium concentrations between 0.03±0.01 and 11.6±1.3 µg/L – values below the WHO guidelines of 30 µg/L for uranium level in drinking water [W18].

50. Uranium conversion, uranium enrichment and fuel fabrication facilities are other steps in the nuclear fuel cycle, which also release small amounts of uranium to the environment [A31]. Tracy and Meyerhof showed that concentrations of uranium in the air near a uranium refinery were 200 times higher than background concentrations [T18]. For monitoring stations in Port Hope, Canada, where a uranium refinery is operating, the annual average concentration varied between 0.001 and 0.0158 µg/m<sup>3</sup> in 1988 and 1989. Uranium concentrations subsequently decreased and varied between 0.005 and 0.00028 µg/m<sup>3</sup> in the early 2000s [C27]. In 2009, elevated levels of uranium were registered in storage reservoirs of liquid radioactive waste at the Mayak facility, Russian Federation: the concentration was 370 mBq/L to 520 Bq/L for <sup>234</sup>U, and 260 mBq/L to 520 Bq/L for <sup>238</sup>U [T21].

51. Concentrations of uranium in surface waters downstream from currently operating uranium mines and mills are relatively low and decrease with distance from the point of effluent discharge. For example, between 2000 and 2012 in the vicinity of Canadian uranium mines and mills within 1 km from the discharge points the mean concentration values ranged from 17 to 0.92 µg/L and decreased to mean values in the range of 1.44 to 0.096 µg/L at distances greater than approximately 10 km from discharge points [C28].

52. Environmental contamination by uranium caused by DU in ammunition used in military conflicts was reported in several studies and in UNEP reports [U3, U4, U5, U6]. Uranium in agriculture soil in Kosovo and Bosnia–Herzegovina averaged 1.8 and 3 mg/kg, while concentrations in public drinking water averaged 0.5 µg/L (16.3 mBq/L of <sup>238</sup>U) and 0.4 µg/L (5.1 mBq/L of <sup>238</sup>U), respectively [C12]. The average uranium concentrations in soil and water were consistent with natural levels, although localized areas of greater concentration were measured in the immediate surroundings of the DU

penetrators [D4, E5, S2]. In the UNEP report on Kosovo, a great variability was observed in uranium concentrations in water samples, with a range between 0.006 and 2.15  $\mu\text{g/L}$  [U4].

53. Carvalho and Oliveira [C12] found high, localized contamination of soil with DU at Djakovica (4,662 Bq/kg of  $^{238}\text{U}$ ; 376 mg/kg). The water samples collected from public water distribution networks and river water ranged from 0.2 to 0.76  $\mu\text{g/L}$  (2.5–9.7 mBq/L of  $^{238}\text{U}$ ) and the air samples ranged from 0.8 to 7.2  $\mu\text{Bq/m}^3$ . Consistent results from a number of studies indicate that environmental contamination by DU has been very localized and confined to the areas of ammunition impact.

54. Concentrations of uranium were measured in surface and groundwater at the Semipalatinsk nuclear test site, where more than 400 nuclear tests were conducted [L28]. The measurements showed that  $^{238}\text{U}$  concentrations in well water within the study area were in the range of 74–213 mBq/L. The results of these studies suggest that diverse human activities involving uranium (from extraction to application) have led to some localized increase of the concentration in the environment.



Table 5. Overview of uranium content in water close to nuclear fuel facilities worldwide

The numbers in italics correspond to calculated data obtained from the mass activity of natural uranium of 25,400 Bq/g and from the relative proportion of <sup>238</sup>U (12.4 mBq/μg) in natural uranium (48.3%); \* mean value

Country	Location	Type of plants	Sample number	Total uranium (μg/L)	<sup>238</sup> U (mBq/L)	Reference
Brazil	Lagoa Real	Mining and ore processing	26	5.45 (0.1–259)	67.6 (1.2–3 212)	[C13]
Canada	Saskatchewan, Beaverloke Lake	Mining	22	100.8	1 250	[Y1]
India	Jaduguda	Mining and ore processing	33	3.2 (0.03–11.6)	39.7 (0.37–144)	[P8]
India	Jharkhand, Narwapahar	Mining	103	0.63 (0.10–3.75)	7.8 (1.24–46.5)	[R7]
India	Jharkhand, Bagjata	Mining	10	3.22* (<0.5–11.2)	40* (<6.2–139)	[G12]
India	Jharkhand, Banduhurang	Mining	10	2.15* (<0.5–27.5)	26.7* (<6.2–341)	[G12]
India	Jharkhand, Bagjata	Mining	40	<61–55.9)	<12.6–693)	[G13]
Kazakhstan and Kyrgyzstan	Kurdai (Kazakhstan) and Shekaftar, Kavak and Kadji-say (Kyrgyzstan)	Mining	10	28.2 (1.9–35.9) (1 525 in lake at mining pit)	350 (23.6–445) (18 910)	[U12]
Kyrgyzstan	Mailuu Suu	Mining and milling	25	0.28 (0.27–0.34) (6 820 for tailings)	3.47 (3.35–4.2)	[C32]
Nigeria	Jos plateau	Abandoned mining	5	0.10 (0.03–0.27)	1.24	[A22]
Nigeria	Abakaliki	Mining	20	2 (0–7)	24.6 (0–87)	[O2]
Portugal	Viseu, Quinta do Bispo & Cunha Baixa	Mining	12	17.7 (1 km) 0.5 (7 km)	220 (1 km) 6.2 (7 km)	[C11]
Tajikistan	Taboshar & Digmai	Mining and milling	6	6.95 (3.4–92)	86.2 (42.2–1 138)	[S28]
USA	Karnes County, Texas Pana Maria	Mining and milling	6	19.7 (14.8–95)	244 (183–1 178)	[M18]
USA	California Juniper		9	3.35 (0.02–52.37)	42.2 (0.25–649)	[K8]

### III. PHYSICAL, RADIOLOGICAL AND CHEMICAL CHARACTERISTICS

#### A. Physical and radiological characteristics

55. Uranium is an actinide and has one of the highest atomic numbers (92) of any naturally occurring element. It is a silvery-white metal that is malleable, ductile, slightly paramagnetic, with a very high-density. In its natural state, crustal uranium occurs as a component of several minerals, including carnotite, uraninite (pitchblende) and brannerite, but is not found in the metallic state in nature. In addition, uranium metal is pyrophoric. Due to its pyrophoricity, it is used in military applications, particularly in armor-piercing projectiles.

56. The three naturally occurring isotopes of uranium ( $^{234}\text{U}$ ,  $^{235}\text{U}$  and  $^{238}\text{U}$ ) behave the same way chemically but have different radiological properties (table 6). Uranium-238 has the longest half-life and consequently the lowest specific activity. It is the most abundant naturally occurring uranium isotope. Among the natural isotopes of uranium,  $^{234}\text{U}$  has the highest specific activity and the shortest half-life [L35, S15]. However, other isotopes of uranium may be produced, such as  $^{233}\text{U}$  that has a very high specific activity ( $3.57 \times 10^8$  Bq/g) [L43].

57. Natural uranium is made of a mixture of the three isotopes described above with about 0.72% of  $^{235}\text{U}$  in mass (table 7). Depleted uranium refers to isotope mixtures that contain a lower percentage of  $^{235}\text{U}$  (from about 0.2–0.3%) while enriched uranium contains typically 3–5%  $^{235}\text{U}$  in mass and may contain up to 90%  $^{235}\text{U}$  for military applications (table 7) [L35, S15].

Table 6. Radiological properties of uranium isotopes [N8]

nt: nuclear transformation

Isotope	Half-life (years)	Daughter nuclide	Emitted energy (MeV/nt)			
			Alpha	Electron	Photon	Total
$^{234}\text{U}$	$2.46 \times 10^5$	$^{230}\text{Th}$	4.8430	0.0137	0.0020	4.8587
$^{235}\text{U}$	$7.04 \times 10^8$	$^{231}\text{Th}$	4.4693	0.0530	0.1669	4.6891
$^{238}\text{U}$	$4.47 \times 10^9$	$^{234}\text{Th}$	4.2584	0.0092	0.0014	4.2691

Table 7. Typical isotopic composition in mass and activity of different types of uranium [L35, S15]

Type of uranium	Mass (%)			Activity (%)			Activity (Bq) for 1 g		
	$^{238}\text{U}$	$^{235}\text{U}$	$^{234}\text{U}$	$^{238}\text{U}$	$^{235}\text{U}$	$^{234}\text{U}$	$^{238}\text{U}$	$^{235}\text{U}$	$^{234}\text{U}$
Natural	99.284	0.711	0.0053	48.2	2.3	49.5	12 400	580	12 474
Depleted	99.807	0.0199	0.0008	86.1	1.1	12.8	12 400	158	1 843
Enriched (3.5% $^{235}\text{U}$ )	96.481	3.46	0.02831	14.7	3.4	81.8	12 005	2 800	66 703

58. Uranium in rock and soil is in secular equilibrium with the daughters of the decay chain. Uranium-238 decays to  $^{234}\text{Th}$  and  $^{234\text{m}}\text{Pa}$  reaching secular equilibrium within about one year. The  $^{238}\text{U}$  decay chain ends with the stable isotope  $^{206}\text{Pb}$ . However, disequilibrium between the uranium isotopes can occur through physical and chemical changes involving water. For example, combinations of physical and chemical processes can lead to a separation of  $^{238}\text{U}$  and  $^{234}\text{U}$  in groundwater [N2]. Uranium-235 and  $^{238}\text{U}$  decays contribute to subsequent formation of 10 or more emitters of  $\alpha$ ,  $\beta$  and  $\gamma$  (figure I). Due to their short half-life,  $^{234}\text{Th}$  and  $^{234\text{m}}\text{Pa}$  (24.1 days and 1.17 min, respectively) are generally present together with  $^{238}\text{U}$ .

## B. Chemical characteristics

59. Uranium has four valencies, which represent the number of valence bonds that uranium can form with other atoms. The most common valencies of uranium in ores are IV and VI. The conditions of transition from valency IV to VI depend on the redox potential of the medium. Compounds containing hexavalent uranium are much more soluble than those containing tetravalent uranium. Hexavalent uranium forms complexes such as uranyl carbonates ( $\text{UO}_2\text{CO}_3$ ) and uranyl sulphates ( $\text{UO}_2\text{SO}_4$ ).

60. Uranium can take many other chemical forms. In nature, it is generally found as uranium dioxide ( $\text{UO}_2$ ) with other compounds, such as in pitchblende. Uranium dioxide ( $\text{UO}_2$ ) is the final product in the manufacture of nuclear fuel pellets used in most reactors, and is also present as DU in MOX. Uranium metal is generally alloyed with other elements (Si, Cr, Al, Fe, Mo, Sn, Al).

61. Uranium metal is pyrophoric and extremely reactive. It oxidizes readily to form triuranium octaoxide ( $\text{U}_3\text{O}_8$ ) and uranium dioxide ( $\text{UO}_2$ ). Uranium trioxide ( $\text{UO}_3 \cdot x\text{H}_2\text{O}$ ) and uranium peroxide ( $\text{UO}_4 \cdot 2\text{H}_2\text{O}$ ) also exist. Triuranium octaoxide ( $\text{U}_3\text{O}_8$ ) is the most stable oxide of uranium and is the form most commonly found in nature. Both triuranium octaoxide ( $\text{U}_3\text{O}_8$ ) and uranium dioxide ( $\text{UO}_2$ ) are solids that have low solubility in water and are relatively stable over a wide range of environmental conditions. Through reactions with acids, bases or chelating agents, compounds such as uranyl nitrate, uranyl carbonate, uranyl chloride, uranyl sulphate and uranyl acetate may also be formed. Ammonium diuranate ( $(\text{NH}_4)_2\text{U}_2\text{O}_7$ ) is a basic product in the uranium fuel cycle, a component of Yellowcake, which is produced during milling and consists of magnesia or ammonium diuranate (respectively  $\text{MgU}_2\text{O}_7$  and  $(\text{NH}_4)_2\text{U}_2\text{O}_7$ ). These compounds are converted to uranium hexafluoride ( $\text{UF}_6$ ) prior to enrichment. During conversion, diuranate is converted to uranium trioxide ( $\text{UO}_3$ ), then  $\text{UF}_4$ , and finally  $\text{UF}_6$  is then enriched from  $^{235}\text{U}$  ~0.7% to  $^{235}\text{U}$  at ~4%. This enriched  $\text{UF}_6$  is then converted into  $\text{UO}_2$  [D6].

62. As indicated above, different chemical forms of uranium are produced throughout the nuclear fuel cycle [G18]. Uranium-fluorine compounds are encountered in uranium processing, with uranium hexafluoride ( $\text{UF}_6$ ) and uranium tetrafluoride ( $\text{UF}_4$ ) being the two most common. The compound  $\text{UF}_6$  is used in the enrichment process of uranium to increase the proportion of  $^{235}\text{U}$ , either by gaseous diffusion or by gas centrifuge. It is prepared industrially by the reaction of  $\text{UF}_4$  powder with fluorine gas. Uranium tetrafluoride is obtained by treating  $\text{UO}_2$  with gaseous fluorhydric acid. It is a non-hygroscopic, non-volatile compound and very soluble in water. In the presence of water vapour, it undergoes pyrohydrolysis and becomes  $\text{UO}_2$ . When gaseous  $\text{UF}_6$  is released into air or as it enters the respiratory tract, it hydrolyzes with moisture in air to produce hydrofluoric gas and particulate  $\text{UO}_2\text{F}_2$ . The oxidation states and crystallographic forms of uranium in DU particles have been determined from selected samples collected at different sites in Kosovo and Kuwait contaminated by DU ammunition during conflicts [L39]. Oxidized uranium (+6) was found in large, fragile and bright yellow DU particles released during a fire at DU ammunition storage facilities in Kosovo and Kuwait and crystalline phases such as schoepite

( $\text{UO}_3 \cdot 2.25\text{H}_2\text{O}$ ), dehydrated schoepite ( $\text{UO}_3 \cdot 0.75\text{H}_2\text{O}$ ) and metaschoepite ( $\text{UO}_3 \cdot 2.0\text{H}_2\text{O}$ ) were identified [L39]. These DU particles were rapidly dissolved indicating a high degree of potential mobility and bioavailability. Crystalline phases such as  $\text{UO}_2$  and metallic uranium or U–Ti alloy were also determined in impacted DU particles from Kosovo and Kuwait.

## IV. HUMAN EXPOSURE

### A. Exposure of members of the public

63. Natural uranium exposure of humans occurs through food, water and inhalation. Reviews of autopsy data show that the skeleton is the main site of accumulation of uranium (~80% of total) [B53, K6, S25, U18]. This result, observed in a United States population, was corroborated by measurements made in the United Kingdom [H7, H8] and Japan [I18]. Publications differ about whether the distribution of uranium in the skeleton appears to be uniform [H12] or not [S24]. The age dependence of uranium concentration in the skeleton was also investigated in humans (from six months to 65 years) from vertebrae bones collected in Canada from population exposed to high uranium levels in drinking water [L11]. The data indicated higher uranium accumulation at six months.

64. Fisenne et al. [F6] summarized numerous publications from 12 countries concerning uranium concentration in human tissues, including blood, soft tissue and bone. This analysis demonstrated small differences in uranium concentration in soft tissue and bone. The authors calculated an average of 30  $\mu\text{g}$  for the skeletal burden. The body burden of uranium in humans was estimated between 50 and 60  $\mu\text{g}$ , with 57% in the skeleton, 20% in muscles, 16% in fat, 4% in blood, 2% in the lungs, 1% in the liver and 0.36% in kidneys as presented in figure II [F6]. One publication mentioned uranium levels in the human brain [K6] with values between 0.18 and 0.77  $\mu\text{g}$  of uranium/kg ( $n=3$ ), corresponding to 0.4 to 0.99%.

65. The Committee in its UNSCEAR 1977 Report [U7] provides further reference concentrations of  $^{238}\text{U}$  in various human tissues expressed in mBq/kg: 20 mBq/kg in the lungs, 3 mBq/kg in the liver, 30 mBq/kg in the kidneys, 5 mBq/kg in muscles and 100 mBq/kg in the bones. Despite some differences, these values and those reported by [F6] are similar. High uranium concentrations were also measured in the kidneys in humans [A2, D20, S25]. Calculations made for four age groups (infant, one-year-old, ten-year-old, adult) indicated that long-term chronic uranium ingestion would result in a kidney burden of 6.6% of daily uranium intake for all age groups [C21].

66. Fisenne and Welford [F4] measured an average kidney content of 0.13  $\mu\text{g}$   $^{238}\text{U}$  from 12 New York City dwellers, aged 20–60. An average daily New York City diet of 1.3  $\mu\text{g}$  yields a blood uptake of 0.026  $\mu\text{g}$ . The kidney-to-blood uptake ratio was estimated at 4 and the bone-to-blood uptake ratio at 3.3. Figure III shows the average daily dietary intake of  $^{238}\text{U}$  measured in 16 cities in 12 countries [F7].

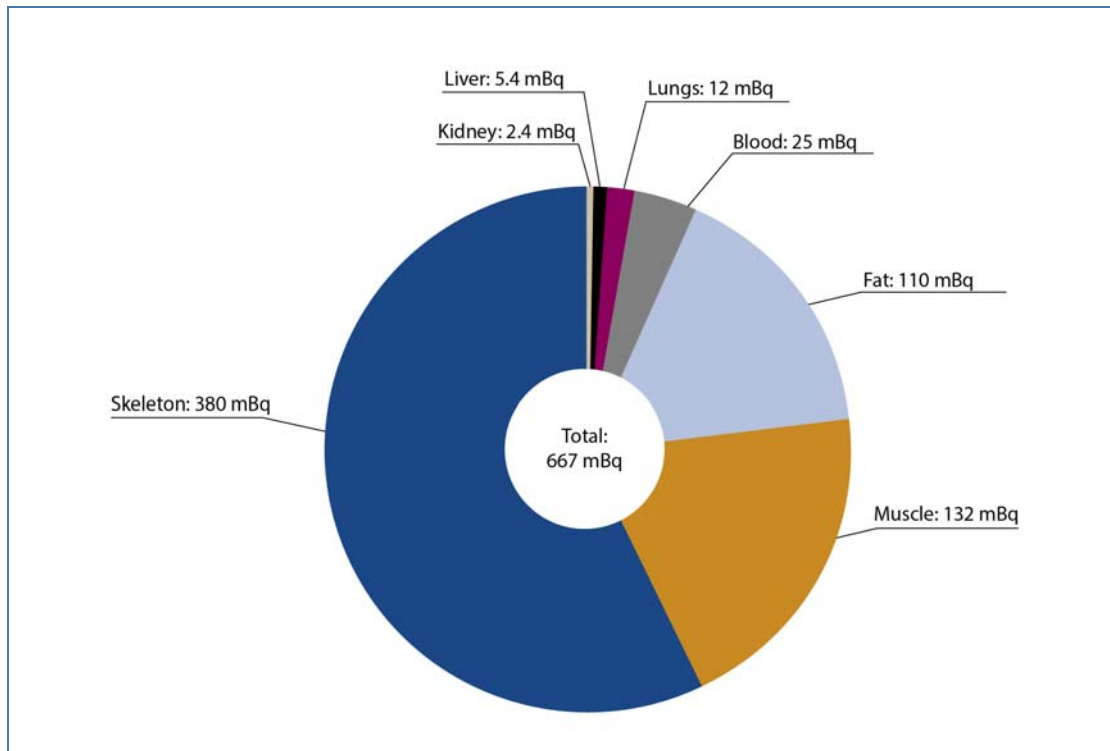
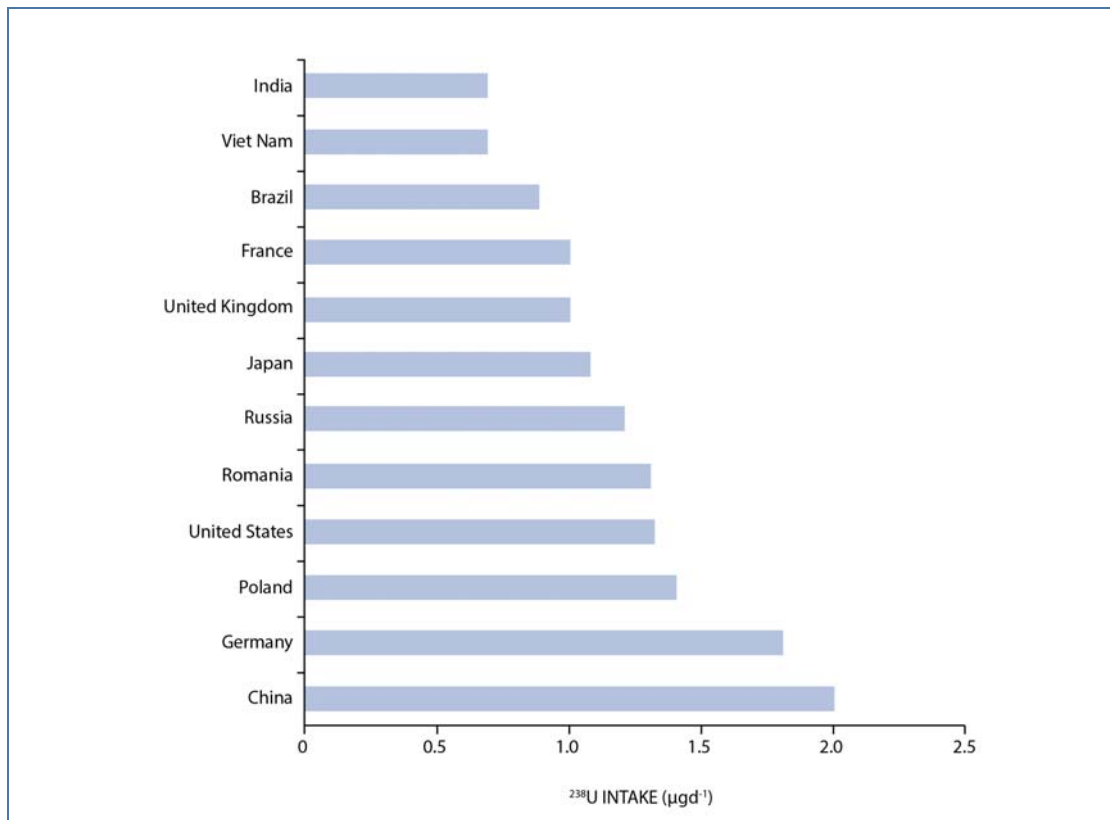
Figure II. Distribution of  $^{238}\text{U}$  in human body [F6]Figure III. Average daily  $^{238}\text{U}$  dietary intake measured in 12 countries [F7]

## B. Occupational exposure

67. Exposure to uranium may also be relevant to occupational exposure, notably for workers involved in electricity production in nuclear power reactors or at any stage of the nuclear fuel cycle. Each stage of the nuclear fuel cycle is associated with distinct exposure characteristics [D6, D7]. During mining, workers may be exposed to various uranium compounds exhibiting different solubility such as Yellowcake. Further, workers in metal mines, such as underground gold mines, may also be exposed to uranium.

68. Several tissues were collected at the autopsy of workers by the United States Transuranium and Uranium Registries (USTUR) [F3]. Some cases have been analysed following uranium exposure [A34, R31]. Accidental exposure to uranium hexafluoride ( $UF_6$ ) led to long-term (65 years) retention of uranium in the deep lungs and in thoracic lymph nodes [A34]. High concentration of uranium in tracheobronchial lymph node was also found in other cases without accidental exposure [R31].

69. Often, data on worker exposure are restricted to measurements of external radiation exposure. For instance, Anderson et al. reported that only 16% of the Oak Ridge Gaseous Diffusion Plant (ORGP) workers were monitored between 1948 and 1988 for internal exposure to uranium by urinalysis [A12]. The difficulty is that monitoring programmes for internal exposure need a combination of bioassay techniques, e.g. urine and faecal analysis, especially in workplaces where compounds of different solubility are handled and also in cases of accidental intakes [J6].

70. Following inhalation of insoluble forms of uranium, the lungs may retain the highest concentrations of uranium [A2, I19]. Adams et al. reported measurements of uranium in kidney and bone following lifetime occupational exposure to uranium aerosols [A2], showing greater retention in bone than kidneys, as seen in data for natural uranium in tissue samples from members of the public.

## C. Measurement of uranium

71. The amount of uranium taken into the body can be assessed from external radiation measurements or by bioassay sampling (urine or faeces). The choice and efficacy of each procedure is dictated by the route of intake, the pattern of exposure, the physical and chemical form of the uranium, the time between intake and measurement, and the detection limit of the analytical procedure used [A31, L9, S30].

72. Exposure to uranium can be assessed through the detection of uranium in the urine [B4, C18, C31, D21, L18, L21, M62, S37, S39, W12, W23]. After absorption through oral, dermal and inhalation routes, uranium is excreted in urine mostly as uranyl ions. Uranium urinalysis data have been shown to correlate with airborne uranium exposure when averaged over time and the contribution from ingested uranium is insignificant. Thus, urinalysis can be used to verify the adequacy of air sampling and as a non-invasive method for the estimation of exposure [C18, D9, T7].

73. In vivo external radiation measurements can be used to determine the amount of uranium in the respiratory tract or whole body. The energy of the main gamma emission from  $^{235}U$  is 186 keV. Specialized counting systems (e.g. using germanium semiconductor detectors) are required. The minimum detectable activity (MDA) of uranium in the chest depends on the isotopic mix of  $^{235}U$  and  $^{238}U$  and also on the total amount of uranium in the chest or in the whole body. However, it is of the order of 4 Bq of  $^{235}U$  and 100 Bq of  $^{238}U$  [L25]. When  $^{234}Th$  has reached secular equilibrium with  $^{238}U$ , photon emissions from  $^{234}Th$  may be used in addition to those from  $^{235}U$  to further reduce the detection

limit, by summing the  $^{234}\text{Th}$  and  $^{235}\text{U}$  photopeaks. Kramer et al. have reported an MDA of 4 mg (i.e. 49 Bq of  $^{238}\text{U}$ ) [K13]. The detection limit is a function of the chest wall thickness of the measured individual. This parameter must be measured in order to interpret in vivo measurements of uranium in the respiratory tract.

74. Measurement of uranium excreted in urine after exposure is potentially a more sensitive method than chest monitoring to determine the amount of inhaled uranium. The limit of detection by alpha spectrometry is approximately 0.1 mBq of  $^{234}\text{U}$ ,  $^{235}\text{U}$  or  $^{238}\text{U}$  in a 24-hour urine sample. Counting times of approximately one week are required to achieve this sensitivity. For natural uranium, a measurement of 0.1 mBq of either  $^{234}\text{U}$  or  $^{238}\text{U}$  would correspond to about 8 ng of total uranium. Specialized mass spectrometric techniques (such as multicollector inductively coupled plasma mass spectrometry; high-resolution inductively coupled plasma mass spectrometry; or thermal-ionization mass spectrometry) can provide isotopic analysis at levels lower than can be achieved by alpha spectrometry [K12, L20]. Synchrotron-based X-ray techniques (e.g. X-ray fluorescence microscopy, X-ray absorption fine structure, X-ray diffraction) may be also used for uranium measurements [C15, P5].

75. The use of faecal assay is confined to intakes by inhalation of relatively insoluble forms of uranium, and dose assessments using these data are subject to substantial uncertainties [D8, J6]. Measurement of uranium in hair could be used as an indicator of body burden in contaminated subjects [B16, I23, J3].

76. Many studies have reported urinary excretion of uranium in humans. The National Report on Human Exposure to Environmental Chemicals [C16] gives uranium concentrations in both  $\mu\text{g/L}$  and  $\mu\text{g/g}$  creatinine. Expressed in  $\mu\text{g/L}$ , mean levels of uranium in the general United States population range from 0.005–0.009  $\mu\text{g/L}$  according to surveys conducted from 1999 to 2012 on 18,266 individuals. Oeh et al. [O1] measured uranium content in 113 urine samples from 63 occupationally unexposed persons in Germany. The urinary excretion of uranium per day was in the range of 1.4 to 77.5 ng with a geometric mean of 13.9 ng and median of 14.4 ng. Höllriegl et al. [H21] measured the uranium content in urine in the general public of Nigeria with creatinine normalized values from <10.4 to 150 ng/L (median 13.8 ng/L) and from 2.52 to 252.7 ng/g creatinine (median 33.4 ng/g). Malátová et al. [M8] measured daily excretion of  $^{238}\text{U}$  in urine in the general population (mean 0.311 mBq, range 0.011–2.88 mBq). The measured urinary excretion per day among 40 active uranium miners indicate a mean value of 0.56 mBq with a range of 0.08–2.77 mBq of  $^{238}\text{U}$  normalized to 1.7 g daily creatinine excretion [M7]. A study performed in Italy indicated that the daily excretion for the Italian volunteers ranges from 8.2 ng to 59 ng uranium [B1]. The lowest daily excretion was observed for the youngest volunteer (seven years old).

## V. BIOKINETICS

77. The main routes of intake of uranium into the human body are ingestion and inhalation. Transfer through intact skin is a minor route. Wounds require consideration in occupational exposure. In general, occupational exposure arises primarily through inhalation of dust containing uranium or following injury. Exposure of the general public arises mainly through ingestion of water or foodstuffs containing uranium. The extent of transfer of ingested or inhaled uranium to blood depends on its chemical form [I10, N2].

## A. Inhalation

78. The intake of radionuclides is determined by the air concentration and by the respiratory characteristics of the subjects, particularly the ventilation rate, which changes according to the level of exercise and determines the volume of air inhaled and the deposition of inhaled radionuclides in the airways of the lungs.

79. For radionuclides inhaled in particulate form, regional deposition in the respiratory tract is governed mainly by the size distribution of the aerosol particles [19]. Deposition fractions of gases and vapours are determined by their chemical form. After deposition in the respiratory tract, absorption and transport of radionuclides involve three general processes. Material deposited in the anterior nasal passage is removed by extrinsic means such as nose blowing. In other regions, clearance is competitive between upward particle transport out of the lungs and dissolution and absorption to blood from the lungs. Particles escalated out of the lungs are subsequently swallowed and pass through the alimentary tract where absorption can occur.

80. The ICRP human respiratory tract model describes the biokinetics and dosimetry of inhaled material and is used to calculate the inhalation dose coefficients that are in general use for radiological protection and scientific purposes [18]. This model represents the deposition of inhaled radionuclides in the different regions of the respiratory tract, and the clearance of the deposited activity by mechanical transport and absorption to blood. Mechanical particle transport rates are taken to be the same for all material, but are altered by factors such as smoking and disease. Absorption into body fluids depends on the physical and chemical form of the deposited material [17]. Absorption is modelled as a two-stage process: dissolution (dissociation of material into body fluids) and uptake of soluble material. Uptake into blood is usually treated as instantaneous while dissolution is time dependant and modelled by three parameters: a fraction ( $f_r$ ) of the activity is rapidly dissolved at a rate ( $s_r$ ), the remaining fraction ( $1 - f_r$ ) is dissolved at a slower rate ( $s_s$ ).

81. The absorption rate of a given compound may vary greatly depending on its method of production and history. The ICRP recommends that the absorption rate of any material should be determined from the study of the material itself. In the absence of data, ICRP recommends default parameters for three reference absorption types: Type F (fast), corresponding to rapid and complete absorption of the radionuclide with a half-time of about 10 min; Type M (moderate), corresponding to the absorption of 20% of the activity with a half-time of 10 min; Type S (slow), corresponding to the absorption of 1% with a half-time of 10 min [P4].

82. Hodgson et al. [H20] and Ansoberlo et al. [A15] reviewed the absorption kinetics of uranium compounds handled in the British and French nuclear industry. In vivo experiments in rats and in vitro dissolution studies led to the classification of  $\text{UO}_2$  and  $\text{U}_3\text{O}_8$  as Type S; mixed oxides,  $\text{UF}_4$ ,  $\text{UO}_3$  and  $(\text{NH}_4)_2\text{U}_2\text{O}_7$  as Type M; and  $\text{UO}_4$ ,  $\text{UO}_2(\text{NO}_3)_2$  and  $\text{UO}_2\text{F}_2$  as Type F. In addition, these studies provided specific absorption parameter values for each of these compounds. Duport et al. [D32] studied the solubility of radioactive dust present in the workplace atmosphere from three types of Canadian uranium ores—Yellowcake,  $\text{UO}_2$  and  $\text{UO}_3$ —using simulated lung fluid and determined their solubility classification. Solubility studies were conducted in Canada on material from various uranium mining and production facilities [R17]. Bečková and Malátová [B10] studied the solubility of dust samples from the underground uranium mine, Rožná, using simulated lung fluid and calculated specific absorption parameter values for  $^{238}\text{U}$ ,  $^{234}\text{U}$  and  $^{230}\text{Th}$ . The dissolution parameters calculated for  $\text{UF}_6$  mixture were higher than the current ICRP dose coefficient for Type F uranium (factor 2–7) [A34].

83. Models allow dose calculation from the inhalation of uranium particles in different chemical forms and in several sizes. However, specific data might be needed for remediation and decommissioning



activities potentially generating uranium nanoparticles [T20]. A study of inhaled nanoparticles of uranium in rats [P18] showed that 97% of inhaled particles were deposited in the deep lung and partly translocated to the pulmonary interstitium. Approximately 22% of these deposited particles were rapidly cleared (lung retention half-life of 2.4 h) and for the 78% remaining, the lung retention half-time was estimated at 1,412 days. The ICRP is currently developing material specific absorption parameter values for compounds of uranium and is revising the default parameter values for Type F, M and S compounds.

## B. Ingestion

84. Material may reach the alimentary tract either directly by ingestion or indirectly by transfer from the respiratory tract or from the systemic circulation. Absorption takes place largely in the specialized absorptive region of the small intestine [L2]. The extent of absorption of individual radionuclides is dependent on the chemical properties of the element, and also the specific form of the intake. It is quantified by the fraction of element reaching blood following entry in the alimentary tract. The absorption and retention of radionuclides in the human alimentary tract are described in the human alimentary tract model produced by ICRP [I14]. This model depicts transfer of ingested material between alimentary tract regions, faecal elimination and absorption into blood [I14]. In the ICRP model, the fraction  $f_1$  represents the small intestinal absorption, and the symbol  $f_A$  refers to the total absorption from the different sectors of the human alimentary tract, including the walls [I14].

85. Soluble uranium is absorbed throughout the small intestine [D25, K9]. Comparative data between species (rabbit, rat, hamster, dog, baboon, pig and human) have been provided by several authors [F11, T19, W26]. Tracy et al. reported a gastrointestinal absorption factor of 0.06% in rats and rabbits [T19] while Frelon et al. reported a value of 0.4% in rats [F11] for uranyl nitrate administered in drinking water. Leggett and Harrison [L23], Zamora et al. [Z5, Z7] and Wrenn et al. [W27] reviewed the uptake of ingested uranium from the alimentary tract in environmentally exposed human subjects and in volunteer studies. The distribution of  $f_A$  values was in a range of 0.001 to 0.063, with daily uranium intake varying from 0.37 to 573  $\mu\text{g}$ . The authors estimated that the best estimate for  $f_A$  was 0.009, with no correlation with age, sex, duration of exposure, and total uranium intake. These values are in accordance with those of another study that found fractional absorption ( $f_A$ ) values in a range from less than 0.1% to about 6% for individual subjects, with the central values from the different studies falling in the range 1–2% and 4% from water for both  $^{234}\text{U}$  and  $^{238}\text{U}$  [S30]. On the basis of available data, the ICRP Publication 69 [I10] takes the fractional absorption of uranium from diet to be 2% in adults.

86. In newborn infants, fractional absorption may increase by a factor of about two due to the higher intestinal permeability [I14]. This higher absorption in newborns was measured in different species (rats, guinea pigs, pigs, dogs) [S45, S47]. On the basis of animal data, ICRP recommended an  $f_1$  value of 0.04 for infants and 0.02 for anyone more than one year of age [I10]. Chen et al. measured uranium concentrations in 73 bone ash samples of young children residing in a Canadian community known to have an elevated level of uranium in its drinking water supply [C22] and estimated fractional absorption with confidence intervals as wide as  $0.093 \pm 0.113$  for infants and  $0.050 \pm 0.032$  for children of 1–7 years. In another extended study by Chen et al. [C23], the absorption fractions were estimated to be  $0.030 \pm 0.022$  for children and youths of 7–18, and  $0.021 \pm 0.015$  for adults of 18–25 years of age.

87. Experimental studies have shown that fractional absorption depends strongly on the ingested chemical forms. The ICRP is currently revising its Publication 69 [I10] and will adopt an  $f_A$  value of 0.002 for relatively insoluble compounds (e.g.  $\text{UO}_2$ ,  $\text{U}_3\text{O}_8$ ) and an  $f_A$  value of 0.02 for all other more soluble chemical forms [P4]. A biokinetic model was recently developed to describe uptake and retention in hair following ingestion [L34].

## C. Absorption

88. Few human data are available on uranium transfer through skin in a report of the National Council on Radiation Protection and Measurements [N3] and in a review of the Armed Forces Radiobiology Research Institute [M17]. Accidents involving workers with extensive skin exposure to uranium have been reported in the other reviews. Lu and Zhao indicated a rapid increase in the uranium level in urine followed by severe kidney dysfunction [L48] with a return to normal values at post-accident day 30. These results were similar to the clinical follow-up made on workers with acute uranium compound intoxication [S16]. Acute renal failure occurred for several days post-accident with recovery one month later. The result of a 33-year follow-up showed that kidney and liver functions were normal [S49].

89. In the use of DU munition, small particles originating from DU dust can contaminate open wounds, and embedded DU fragments may be implanted in muscles. Uranium urine concentrations following accidental intramuscular implantation of metal DU fragments were measured in United States service members exposed to DU through incidents involving DU munition and vehicles protected by DU armour [M25]. Uranium values were from 0.001 to 39.955 µg/g creatinine.

90. Several in vivo studies of rodents with uranium exposure of intact skin [D10, O4, T23] demonstrate that very soluble forms of uranium such as uranyl nitrate and ammonium uranyl tricarbonate are able to diffuse through the skin layer [L47]. The LD<sub>50</sub> of uranium depended on the species as follows: rabbits >rats >guinea pigs >mice. This toxicity increased with the time and the area of exposure. In vitro Franz diffusion chamber model [T23] and in vivo hairless rat model may be used for evaluation of uranium passage through intact skin [P16, P17]. An in vivo study showed that a significant uptake of uranium from a uranyl nitrate solution could occur within the first six hours of exposure after skin contact. Furthermore, as high uranium concentration remained present at the deposit site for up to 24 hours after contamination, skin provided a reservoir for uranium that remained bioavailable [P17].

91. Percutaneous diffusion of uranium was also studied on damaged skin from hairless rats, following an abrasion (*stratum corneum* removal) [P15, P17]. In vitro study of biopsies showed that the percutaneous absorption of uranium increased with the impairment of the *stratum corneum*. Ex vivo studies with biopsies showed an increase in the diffusion of uranium through skin after abrasion compared with that through intact skin. These results have been confirmed in vivo in hairless rats [P16].

92. The NCRP's biokinetic model describes the mobilization of radionuclides, including uranium, entering the body through a wound to blood [N3]. Three wound retention categories were described, corresponding to contamination with soluble forms, colloids, particles or fragments. The uranyl ion (UO<sub>2</sub><sup>2+</sup>) was classified as a weakly-retained radionuclide, and UO<sub>2</sub> oxide particles behaved rather as strongly-retained radionuclides.

## D. Systemic distribution, retention and excretion

93. The translocation of uranium to blood strongly depends on the physical and chemical form of the initial compound [A15]. After its absorption to blood, uranium is present mainly as uranyl ions complexed to proteins (e.g. transferrin, albumin) or bicarbonate anions [A16]. The main sites of deposition of uranium from the circulation are the skeleton, kidneys and general soft tissues. Human and animal data show that urinary excretion is rapid with about two thirds of uranium reaching blood excreted in the first 24 hours and a further 10% over the next 5 days. Most of the remaining uranium is excreted over a period of a few months, but a small percentage of the amount injected may be retained for a period of years [L22].

94. The work of Leggett [L22] was used by ICRP [I11] to propose a reference model for uranium biokinetics. This model is constructed within a physiologically-based framework that is also applied to the alkaline earth elements. Rates of uranium transfer between plasma, red blood cells, skeleton, liver, kidneys, other soft tissue and excretion pathways are based on measurement of uranium in humans and animals and consideration of the physiological processes. The model considers age-related changes in organ and tissue uptake and retention of uranium. The ICRP will use the same model in ongoing revisions of dose coefficients [P4].

95. The United Kingdom Royal Society [R28] used the ICRP's biokinetic models to estimate the concentrations of uranium in the kidneys following chronic exposure over one year at a constant daily uptake of 1 µg of uranium to blood. The estimated uranium concentration in the kidneys was 0.0056 µg/g kidney after one year and 0.011 µg/g kidney after 50 years of contamination. This result is not in accordance with the result of other studies. For instance, a study measured <sup>238</sup>U in diet and kidney tissue in residents of New York and showed that a daily intake of 1.27±0.03 µg resulted in a uranium concentration in the kidneys of 0.00043±0.26 µg/g that was constant over ages <20 years to >60 years old [F4].

96. Several studies have found that uranium can be incorporated into brain tissues [B11, G10, L30, O7]. It has been demonstrated by an in situ rat brain perfusion method that uranium is able to cross the blood-brain barrier [L27] but the mechanism by which uranium is transferred to the brain is unknown. After acute, subchronic or chronic exposure, low uranium concentrations are found in the various structures of the brain [B6, F8, H24, L38, P11, P12]. The level of uranium in the brain, notably in olfactory bulbs, was greatest after inhalation [H26, T15]. Such uranium concentration in olfactory bulbs as compared to other cerebral structures is attributable to the direct transfer of uranium via olfactory receptor neurons [I6, T15].

97. Mean values of uranium concentrations in human breast milk were reported as 0.03 µg/L (0.76 mBq/L) [W9] and 0.30 µg/L (7.6 mBq/L) [C1]. The daily intake of uranium of mothers is 0.03±0.019 µg/kg (mean±SD) [W9]. These values are in accordance with values measured in several animal studies, which suggest similar transfer processes (see also table 3).

## E. Materno-fetal transfer

98. Few data are available on materno-fetal transfer in humans and in animals. Some publications have reported uranium concentrations in fetal samples [B46, B47, L26, S17, W10], in placenta [B47, S17, W10], in amniotic fluid [C14, S17] and in cord blood [G22].

99. Ham et al. [H7] reported uranium concentrations measured in human fetus and Bradley and Prosser in placenta samples [B47]. The activities of <sup>238</sup>U ranged from 0.1 to 9 mBq/kg in the fetal samples of human fetus and from <1 to 11 mBq/kg in placenta samples. Uranium concentrations ranged from 0 to 0.2 µg/L (mean=0.024 and median=0.005) in human amniotic fluid [C14] and from 0.003 to 0.834 µg/L (mean=0.104 and median=0.057) in cord blood [G22].

100. An experimental study performed by Legrand et al. on pregnant rats exposed to uranium via drinking water (40 and 120 mg/L) indicated no elevated uranium concentration in exposed fetuses as compared to control animals [L26]. Another study performed by Sikov and Mahlum on pregnant rats after injection indicated that only a small fraction of the injected nuclide (148 kBq of <sup>233</sup>U) entered the fetus and the distribution within the fetus was dissimilar from that observed in the dam [S17]. Only 0.06% of injected dose/g body weight was measured in fetal kidneys at 20 days as compared to 5.18 in

the dam. The authors also reported 0.03% injected dose/g body weight in fetus, 0.05% in placenta and 0.001% in the amniotic fluid [S17].

101. The ICRP [I12] has provided biokinetic and dosimetric models and dose coefficients for the embryo, fetus and newborn as a result of intake of radionuclides by the mother. The term fetus refers to the developing human offspring after the eighth week of pregnancy. The equivalent dose to the embryo is assumed to be the same as that to the uterus wall and proportional to the concentration of uranium in maternal soft tissue. The ICRP uses a simple approach for the calculation of fetal doses for the majority of elements and their radioisotopes, including uranium, considering data collected from studies of animals and humans [I12, I13]. Thus, fetal doses from uranium are calculated on the basis of relative concentrations of uranium averaged over the whole body of the fetus ( $C_F$ ) and that of the mother ( $C_M$ ). A conservative  $C_F:C_M$  ratio of 1 is used for intakes of uranium during pregnancy. The distribution of uranium in the fetus is assumed to be 80% to skeleton, 2% to kidneys, and 18% to other tissues [I12].

## VI. DOSIMETRY

102. Absorbed doses in tissues are calculated using dosimetric models such as those of ICRP (e.g. [I7, I10, I11]) and of the Medical Internal Radiation Dose (MIRD) committee [B39]. The absorbed dose is the fundamental quantity that is estimated and averaged over particular tissues and organs. The distribution of absorbed dose from internally deposited radionuclides, here the uranium isotopes, depends on a number of factors, including the distribution of the radionuclides within organs and tissues, and the penetration and range of radiation emitted from the radionuclides. Dosimetric models have been developed for this purpose.

103. Absorbed doses from photons and electrons are calculated by applying Monte-Carlo codes of radiation transport to anthropomorphic computational phantoms representing a reference person [I15]. Alpha particles are considered to be absorbed in the region where they are emitted, except for the skeleton, lung, urinary bladder and alimentary tract where the respective positions of the alpha-emitting radionuclides and of the sensitive target cells are taken into account to assess the dose absorbed by the target cells. In most organs and tissues, local activity and also the radiosensitive target cells are assumed to be uniformly distributed. However, in these few specific tissues, the identification of the putative radiosensitive cells allows a more precise definition of the source and target geometry of irradiation, which is of concern for the short-range alpha particles emitted by uranium isotopes. The target cells identified in the thoracic airways include basal and secretory cells in the bronchial epithelium, endothelial cells such as those of capillary walls, and type II epithelial cells in the alveolar-interstitial region [I18].

104. Following the ICRP, the equivalent dose in a region  $T$ ,  $H_T$ , is defined as:

$$\sum_R w_R D_{T,R}$$

where  $D_{T,R}$  is the average absorbed dose in region  $T$ , due to radiation of type  $R$ ;  $w_R$  is the radiation weighting factor for radiation  $R$  and is equal to 1 for photons and beta particles and 20 for alpha particles [I10, I15].

The effective dose  $E$  is defined as a weighted average of equivalent doses to radiosensitive tissues of the body:

$$E = \sum_t w_T H_T = \sum_T w_T \sum_R w_R D_{T,R}$$

where  $w_T$  is the tissue weighting factor for tissue  $T$ , with the sum of  $w_T$  being 1. The committed effective dose  $E_T(\tau)$  is defined as the effective dose delivered over the time  $\tau$  following intake of a radionuclide. The  $\tau$  is usually set to 50 years for adults and for children up to the age of 70 years so as to cover life-long irradiation [I10].

105. Doses from the inhalation or ingestion of unit mass of uranium can be determined by multiplying the corresponding dose coefficient (i.e. for  $^{238}\text{U}$ ,  $^{235}\text{U}$  and  $^{234}\text{U}$ ) by the isotopic activity for each level of enrichment [I7, I11].

106. The ICRP provides reference dose coefficients per intake of uranium isotopes for workers [I7] and members of the public [I10] in accordance with the international safety standards of the IAEA [I4]. The values for inhalation by workers and ingestion by members of the public are given in tables 8 and 9, respectively. The  $f_1$  values of the ICRP model depend on age, and the model for the systemic behaviour of uranium is also age-dependent, and so the committed effective dose per unit intake calculated for ingestion of soluble uranium by members of public exhibits age-dependence (table 9).

Table 8. Committed effective dose per intake (Sv/Bq) for inhalation by workers (for 5  $\mu\text{m}$  AMAD particulates) [I7]

Solubility group of uranium compound: F (fast soluble), M (moderately soluble) and S (slowly soluble)

Isotope	Absorption type		
	F	M	S
$^{234}\text{U}$	$6.4 \times 10^{-7}$	$2.1 \times 10^{-6}$	$6.8 \times 10^{-6}$
$^{235}\text{U}$	$6.0 \times 10^{-7}$	$1.8 \times 10^{-6}$	$6.1 \times 10^{-6}$
$^{238}\text{U}$	$5.8 \times 10^{-7}$	$1.6 \times 10^{-6}$	$5.7 \times 10^{-6}$

Table 9. Committed effective dose per unit intake (Sv/Bq) for ingestion of soluble uranium by members of public [I10]

Isotope	Age at intake					
	3 months	1 year	5 years	10 years	15 years	Adult
$^{234}\text{U}$	$3.7 \times 10^{-7}$	$1.3 \times 10^{-7}$	$8.8 \times 10^{-8}$	$7.4 \times 10^{-8}$	$7.5 \times 10^{-8}$	$5.0 \times 10^{-8}$
$^{235}\text{U}$	$3.5 \times 10^{-7}$	$1.3 \times 10^{-7}$	$8.5 \times 10^{-8}$	$7.1 \times 10^{-8}$	$7.0 \times 10^{-8}$	$4.7 \times 10^{-8}$
$^{238}\text{U}$	$3.3 \times 10^{-7}$	$1.2 \times 10^{-7}$	$8.0 \times 10^{-8}$	$6.8 \times 10^{-8}$	$6.7 \times 10^{-8}$	$4.5 \times 10^{-8}$

## VII. BIOLOGICAL EFFECTS

### A. Chemical versus radiological toxicity

107. Uranium represents a particularly difficult problem for internal emitter studies because of its chemical and radiological toxicities. It is a radioactive heavy metal, and it is difficult to characterize differences in responses to the metal component alone, the radioactivity alone, or the possible combined effects of both. Some studies on DU have attempted to define the metal component, however these are limited by the presence of radioactivity.

108. Despite the dual toxicity of uranium, few studies investigate the respective parts of its chemical and radiological toxicities. As with all chemicals, the chemical toxicity of uranium is linked to its ability to interfere with compounds and biochemical processes in living organisms. The chemical action of all isotopes and isotopic mixtures of uranium is independent from the specific activity because chemical action depends only on chemical properties [W13]. However, it is dependent on its physical and chemical forms. For instance, the NOAEL values measured for uranium effects vary depending on the absorption type of uranium compound, i.e. F (fast soluble), M (moderately soluble) and S (slowly soluble). Different reports gave NOAEL values as a function of the administration mode and the exposure duration [A31, W14].

109. Concerning the radiological hazard of uranium, alpha particles do not penetrate beyond the outer layer of skin, except in regions of thinner skin (the depth varies typically in the range 20–100  $\mu\text{m}$ ). The impact on health of alpha particles of uranium is expected mainly after internal contamination and depends partly on the route of exposure (inhalation or ingestion) [W14].

110. Both natural uranium and DU pose primarily chemical rather than radiological hazards in the short term. The toxicity of uranium depends on its chemical form and the route of exposure [A31]. The potential health effects arising from uranium exposure are discussed below. Some effects are related to the chemical toxicity of uranium, notably renal effects, while other effects are mainly due to the radiological toxicity of uranium, such as tumorigenic effects.

111. The relative importance of chemical and radiological toxicities of uranium thus depends on the degree of enrichment of  $^{235}\text{U}$  (and  $^{234}\text{U}$ ), the compound solubility, the chemical speciation and the mode of incorporation [A31, S46, T9]. Chemical toxicity from uranium exposure appears mainly in the kidneys and is assumed not to occur below a threshold concentration. The thresholds given in the literature are most often derived from a NOAEL in animal experiments with the application of an appropriate safety factor for transposition to humans [A31]. Human autopsy data are used to confirm these observations [A31, S43].

112. Stradling et al. discussed anomalies between radiological and chemical limits for uranium after inhalation by workers [S41]. As a consequence of the different procedures used in their calculation, they are incompatible and adherence to one limit may result in a breach of the other. They concluded that for chronic intake by members of the public, it can be deduced that a unified exposure level of 0.5  $\mu\text{g}/\text{kg}$  per day or a daily intake of 35  $\mu\text{g}$  would be acceptable in most cases. More recently, Thorne and Wilson proposed higher limits corresponding to 2  $\mu\text{g}/\text{kg}$  per day or a daily intake of 140  $\mu\text{g}$  [T9].

## B. Kidneys

113. The limited human studies suggest that damage to the kidneys can be detected following chronic exposure that results in uranium concentrations as low as 0.1 µg per gram kidney [R28]. Human studies also suggest that acute intake which leads to a peak uranium level of about 1 µg per gram kidney can lead to detectable kidney dysfunction [R28]. Some authors have aimed to predict renal concentrations in human populations exposed to uranium for dose assessments [C21, S31]. In the epidemiological section some human data are presented of populations exposed to high uranium concentrations in drinking water.

### 1. Acute exposure

114. Morphological renal modifications induced by uranium (from 0.1 mg/kg after injection) were reported in rodents in several experimental studies, suggesting that the kidneys are the major target organ of acute uranium toxicity independent from the route and duration of exposure [B25, D17, G27]. Histopathological changes, including degenerative changes or necrosis of the proximal tubular epithelium and glomeruli, were reported after acute exposure in rats [D12, M16]. Further, some histological alterations were noted in renal tubules of rats following chronic exposure with elevated concentration of uranium [G10, O7]. Thus, acute exposure may lead to alteration of glomerules and tubules, whereas chronic exposure to uranium seems to affect only tubular functions. Following intramuscular injection of DU, rats undergo dose-related tubular necrosis and glomerulonephritis. After 30 days, glomerular damage is reversible in rats at all doses (0.1–1 mg/kg) but there is a dose dependent delay in the initiation of the regeneration, seen first in the low-dose group (0.1 mg/kg) [Z17].

115. An experimental study performed by Shiquan et al. on rats considered a wide range in uranium concentrations of 5, 2.5, 1.0, 0.5, 0.25, 0.1, 0.05, 0.025, 0.01, 0.0075, 0.005, 0.0025 and 0.001 mg/kg, administered by intraperitoneal injection as uranyl nitrate [S14]. Doses from 0.01 to 0.05 mg/kg induced slight renal damage. The lowest dose that induced renal damage in all rats of one group was 0.1 mg/kg. At the highest dose (5 mg/kg), necrosis of the proximal tubular epithelium was observed after 6–12 hours, and half the rats died after 6–8 days. Primary damage to the kidneys was necrosis of the proximal tubular epithelium. After repair with regeneration, different degrees of fibrous scarring were found in the kidneys.

116. The third segment of the proximal convoluted tubule is the most affected site in the kidneys of rats [G11] and humans [M9]. Experimental studies performed on dogs [M63] demonstrated that the complexed uranium (VI) is filtered from blood via the glomeruli. In the proximal tubule, water is reabsorbed and uranium is concentrated. As urinary flow acidifies, uranium (VI) complexes are dissociated and uranium can bind epithelial membrane proteins. Uranium kidney retention thus increases with urinary acidity and decreases with uranium complexation.

117. Table 10 summarizes studies of the toxic effects of uranium on the kidneys of rats following acute exposure. Biological effects indicating toxicity of uranium to the kidney were noticed starting from 0.1 mg/kg [Z17] to 126 mg/kg of body weight [F18]. Most of the studies were done on rats and showed a decreased creatinine clearance and an increased electrolyte or protein excretion, indicating tubular alterations of the kidneys [B5, F18] that can also be associated with liver alteration as shown by increased transaminase level [G29].

118. Shude and Suquin et al. reported dose evaluation and medical follow-up of a case of acute uranium compound intoxication [S16, S49]. A nuclear worker received both thermal and acid burns. A

solution of uranyl nitrate hexahydrate was spurted on his body, and uranium was absorbed through the skin to blood. Acute renal failure and toxic hepatitis occurred during several days post-accident and recovery occurred one month later. The amount of uranium taken into the body as a result of this incident was calculated to be 116 mg [S16, S49]. The result of 33 years' follow-up showed that the function of kidney and liver were normal. Chromosome aberrations of peripheral lymphocytes were observed, including ring, fragment and dicentric. The results of other examinations were at normal levels, including peripheral blood, bone marrow, immune system, cardiovascular and respiratory function, endocrine and metabolism [S49].

Table 10. Summary of studies of toxicity of acute exposure in kidneys of adult rats

ip: intraperitoneal; im: intramuscular; iv: intravenous; BUN: blood urea nitrogen; GFR: glomerular filtration rate; LDH: lactate dehydrogenase; AST: aspartate aminotransferase; ALT: alkaline phosphatase; BW: body weight

<i>Uranium compound</i>	<i>Exposure conditions</i>	<i>Post-exposure follow-up</i>	<i>Sex</i>	<i>Biological effects</i>	<i>Study references</i>
Uranyl nitrate	ip 0.001–5 mg/kg	8 days	Male	Necrosis of the proximal tubular epithelium Damage repair with renal fibrous scar Half died after 6–8 days in the highest-dose group	[S14]
Uranyl acetate	ip 0.1–1 mg/kg	30 days	Male	Increased creatinine, BUN and albumin at high dose in serum	[Z17]
Uranyl nitrate	ip 0.5 mg/kg	5 days	Male	Increased creatinine, urea, cholesterol, phospholipids in plasma	[B5]
Uranyl fluoride	ip 0.66 mg/kg	110 days	Male	Decreased kidney weights Increased LDH, AST in plasma and protein, albumin in urine	[D12]
Uranyl nitrate	im 0.2–2 mg/kg	28 days	Male	Decreased plasma ALT, AST, protein and increased urea, creatinine, ALP	[F18]
Uranyl nitrate	ip 10 mg/kg	28 days	Male	Increased concentrations of sodium and protein in urine Decreased GFR	[H6]
Uranyl nitrate	ip 11.5 mg/kg	3 days	Male	Increased creatinine, urea, ALT, AST plasma levels	[G25]
Uranyl nitrate	im 7.9–126 mg/kg	28 days	Male	Decreased BW and died after 3–7 days	[F18]
Uranyl nitrate	ip 5/10/20 mg/kg	2 days	Male	Histopathological lesions Increased plasma creatinine and urea plasma levels	[A18]
Uranyl nitrate	ip 50–500 µg/kg	21 days	Female	Renal morphological alterations (at the first dose, becoming increasingly prominent with higher doses)	[B17]
Uranyl nitrate	iv 15/25 mg/kg	17 hours	Female	Changes in endothelial cell morphology for the higher dose	[A33]



119. Other high human exposure—accidental or deliberate—were reported. Roszell et al. reported 27 cases of human exposure to uranium and the resulting kidney effects [R24]. The uranium burden estimated in the kidneys ranged between 10 µg/g kidney after accidental inhalation of UF<sub>4</sub> powder [L48] and 100 µg/g kidney after deliberate ingestion of 15 g uranium acetate [P9]. Early symptoms of renal failure were noted in the first weeks after exposure, with renal dysfunction observed in some cases until 6 [P9] or 18 months [L48] after exposure. Kathren and Moore re-evaluated the intake and deposition of soluble natural uranium compounds in three men accidentally exposed in an explosion in 1944. One of the three exposed individuals showed an altered clearance pattern for uranium shortly after the accident, possibly from pulmonary oedema associated with concomitant exposure to acid fumes. However, medical examinations of two of the men 38 years after the accident revealed no detectable deposition of uranium [K4].

120. Table 11 provides a summary of the effects of chronic uranium exposure on the kidneys of experimental animals. Conversely, chronic exposure did not clearly induce a toxic effect on the kidneys of mammals, with duration of exposure from three to twelve months and exposure level from 0.02 to 200 mg/kg. Tissue alteration of the tubules or glomerules was observed only for uranium doses above 400 mg/kg [G10, Z13]. After a nine-month chronic exposure to uranium via ingestion of uranium-contaminated drinking water, the kidneys of rats did not show signs of histological lesions for uranium renal levels >3 µg/g (3 µg/g for 120 mg/L [D29] and 6 µg/L for 600 mg/L [P23]).

121. Gilman et al. [G10] noted that effects on the kidneys could be seen at uranium levels of 0.06 mg of uranium per kilogram of body weight per day for male rats. Nevertheless, no rise in histopathological severity with increasing dose was reported: histological lesions starting from the lowest concentration (0.96 mg/L, 0.09 mg/kg body weight) were not significantly different from the kidney lesions observed for the highest concentration (600 mg/L) [G10, G11]. No clear dose-dependent effect was observed after chronic exposure. Indicators of kidney function after acute exposure (0.1–10 mg/kg) included the concentrations of blood urea nitrogen (BUN), creatinine in blood or protein in urine [B5, F18, G23, H6, O7]. Conversely, only limited changes were identified for chronic exposure to uranium in drinking water (2–16 mg/kg) [G11, O7] or from implanted DU pellets (200 mg/kg) [P12, Z13, Z14].

122. Various urinary parameters—including levels of urea, glucose, creatinine, total protein, and albumin and also activities of LDH and N-acetyl-beta-D-glucosaminidase (NAG), and glucose excretion—had the most persistent effect after chronic exposure [G10]. Complementary studies showed that chronic low dose uranium exposure did not modify the nephrotoxic effects of gentamicin renal response as evidenced by the renal tissue levels of kidney injury molecule (KIM-1), osteopontin, and kallikrein [R27]. The results observed with osteopontin were different from those found in clinical studies, which indicated a decreased osteopontin level in urine [P30]. Gentamicin-induced increase in renal levels of KIM-1 was augmented in rats previously exposed to uranium as compared to uncontaminated animals.

123. In a dose-response study (0.27–40 mg/kg) of chronic oral exposure of rats, nephrotoxic and pro/anti-oxidant effects were analysed after three- and nine-month exposure [P23]. The uranium content of the kidneys was proportional to uranium intake after three and 9 months of contamination. It reached 6 µg/g of kidneys for the highest uranium exposed group, a nephrotoxic level for acute intake. Uranium microdistribution analyses showed that it was found mainly in the nucleus of renal proximal tubular cells and to a lesser extent in other renal structures. Nevertheless, no renal impairment was observed according to histological analysis or measurements of sensitive kidney biomarkers such as KIM-1, β<sub>2</sub>-microglobuline or retinol binding protein. Uranium contamination appeared to reinforce the antioxidant system in the kidneys as the glutathione pool increased dose-dependently up to tenfold.

Table 11. Summary of studies of biological effect of chronic exposure to uranyl nitrate on kidneys of male adult animals

PCT: proximal convoluted tubule

<i>Species</i>	<i>Exposure conditions</i>	<i>Follow-up</i>	<i>Biological effects</i>	<i>Study references</i>
Rat	Oral 100 mg/kg	27 days	Histopathological lesions (increased when exposure duration increased)	[G15]
Rat	Oral 0.02–40 mg/kg	91 days	Decreased haemoglobin, erythrocytes, glucose not correlated to the concentration in drinking water Histopathological lesions in the lowest group	[G11]
Rat	Oral 2.7 mg/kg	275 days	Decreased plasma vitamin D and vitamin D target genes in the kidney tissue	[T11]
Rat	Oral 2.7 mg/kg	275 days	Following single exposure to acetaminophen (paracetamol), increased PCT necrosis of the kidney	[G26]
Rat	Oral 2–16 mg/kg	28 days	Increased glycaemia whatever the dose in plasma	[O7]
Mouse	Oral 13–26 mg/kg	122 days	Decreased urea and increased creatinine in plasma	[T4]
Rabbit	Oral 0.02–400 mg/kg	91 days	No biochemical changes Kidney histopathological lesions in the highest group	[G10]
Rat	Muscle implantation 200–600 mg/kg	91 and 360 days	Increased plasma urea, creatinine and urinary beta-2 microglobulin and albumin	[Z14]
Rat	Oral 0.014–8 mg/kg	275 days	No biochemical changes No renal histopathological lesions	[D29]
Rat	Oral 0.27–40 mg/kg	91 and 275 days	Glutathione increase dose-dependently and lipid peroxidation decrease in kidney No nephrotoxicity (biomarkers and histology)	[P23]

124. A study by Silver et al. provided information regarding non-malignant chronic kidney disease [S19], which proved to be non-significant. There was a trend in chronic renal failure deaths in the Colorado uranium miller cohort with duration of uranium milling employment (SMRs of 1.27, 1.33 and 1.53 for 1–2, 3–9 and  $\geq 10$  years of employment, respectively) [P21]. However, when treated end-stage renal disease for those receiving renal dialysis or kidney transplants, the incidence was evaluated using the ESRD program (End Stage Renal Disease) date, there was no excess (SIR=0.71, 95% CI: 0.26–1.65). In the Fernald cohort, mortality from chronic renal disease was not related to uranium exposure [S19] (see also table 18). Other studies of uranium worker cohorts indicated no significant overall excesses of chronic kidney disease death [B38, C20, D33, M26, M27, P24]. Some renal effects were studied in humans following chronic exposure to uranium via drinking water. These data are shown in appendix A, table A11, which summarizes the published literature on the health effects of human exposure to uranium through ingestion of surface or groundwater.

## 2. Influence of age

125. Few studies have investigated the influence of age at exposure on renal toxicity. The first results considering this issue were published before 1920 for studies using dogs [M3]. The author demonstrated that older animals developed more severe uranium poisoning than young animals, associated with more marked histological alterations, leading to an impaired functional capacity [M3]. This result was corroborated by a more recent experiment, also performed on dogs [P10]. Uranium effects on renal function (glomerular filtration rate) were more severe in older (3/4 weeks) than in younger dogs (1/2 weeks). Recent publication of an experiment performed on rats with 0.1–2 mg/kg of uranium acetate indicated a higher uranium concentration in the kidneys of neonatal animals than in prepubertal or adult animals [H22].

126. Magdo et al. studied the effects of the high uranium concentration in drinking water of a private wells used by a family (two adults and five children). The authors measured concentrations of up to (1,160 µg/L) in the groundwater [M5]. The authors evidenced a nephrotoxicity in the youngest family member (a three-year-old child), demonstrating the highest sensitivity to uranium exposure. This case shows potential for significant residential exposure to naturally occurring uranium in well water. It highlights the special sensitivity of young children to residential environmental exposures, a reflection of the large amount of time they spend in their homes, the developmental immaturity of their kidneys and other organ systems, and the large volume of water they consume relative to body mass [M5]. However, this result appears inconsistent with observations made in young rodents.

## 3. Biological mechanisms

127. According to Leggett [L21], uranium binds to the luminal brush-border membrane of tubules. This binding decreases reabsorption of sodium and other compounds, resulting in an increased urinary excretion of proteins, glucose, catalase, phosphate, citrate and sodium without causing cellular damage [B25]. Uranium can then separate from the luminal membranes by a number of mechanisms including association with complexing ligands from the urinary tubular flow, detachment of uranium-bound microvillousities, and elimination of dead cells. The mechanism by which uranium then enters tubular cells has been investigated. Once in the cytoplasm, uranium accumulates in lysosomes, where it precipitates with phosphate, forming microcrystals at high concentrations [M47]. This process induced destruction of the lysosome.

128. The mechanisms of uranium effects on the kidneys have not been fully elucidated. The relations between uranium penetration into and distribution within cells and its toxicity was analysed in kidney proximal tubular cells. Some authors posited that uranium did not need to penetrate cells to exert its toxic effect [L21, M68] while others posited that it did [L1, M47]. Rouas et al. have suggested that the physical form of uranium (soluble or precipitate) and its intracellular localization play a role in cell toxicity [R26]. They suggested that uranium may be visualized in the nuclei in kidney cultured cells exposed to uranyl nitrate. Experimental studies have indicated that uranium exposure of animals (rats or mice) at 5–25 mg/kg may induce changes in solute transport [G11, T5], protein biosynthesis-related genes [T4, T5] or cell signalling [P26, T5].

129. Several studies reported effects of uranium on renal transporters, Na<sup>+</sup>,K<sup>+</sup>-ATPase [B48], sugar transporters [G17, N4, R19], sodium-dependent phosphate cotransporters [M68, M69] and organic cation transporters [M4, S13] but these effects were studied only in vitro using relatively high uranium concentrations.

130. Mitochondrial dysfunctions have recently been demonstrated in rats after injection at 0.5, 1 and 2 mg/kg per intraperitoneal injection [S9]. Isolated mitochondria from the uranyl acetate-treated rat kidney showed a marked elevation in oxidative stress accompanied by mitochondrial membrane potential collapse as compared to the control group. In addition, direct incubation of isolated kidney mitochondria with uranyl acetate (50, 100 and 200  $\mu\text{M}$ ) suggested that uranyl acetate can disrupt the electron transfer chain at complex II and III.

131. To investigate the influence of uranium speciation on its toxicity, cells representative of rat kidney proximal epithelium (NRK-52E) have been exposed to uranyl-carbonate and -citrate complexes, because they are the major complexes transiting through renal tubules after acute in vivo contamination. When citrate is added to the exposure medium, the predominant species is uranium (VI)-bicarbonate. Nonetheless, citrate increases uranium (VI) toxicity and accelerates its intracellular accumulation kinetics without inducing precipitation [C10].

132. Uranium can induce cell death but the exact mechanisms are still unclear. Some proposed mechanisms include apoptosis or genotoxicity [M54, T6, V5]. The mechanisms of acute toxicity of uranium (from 50 to 500  $\mu\text{M}$ ) have been studied in renal cell lines and have shown a specific uranium signature characterized by the downregulation of tubulin and actin [P27]. The most investigated mechanism to explain uranium toxicity is the oxidative stress response, investigated both in vitro on cell cultures and in vivo following acute or chronic exposure in rats and mice [B5, S9, T4, T5, T6]. The results of these studies suggested uranium-induced oxidative stress imbalance with an increased reactive oxygen species production associated with a depletion of endogenous cellular antioxidants for elevated concentrations administered to cells ( $>400 \mu\text{M}$ ) or to animals ( $>0.5 \text{ mg/kg}$ ).

133. Several studies have focused on the interaction between iron metabolism and uranium, in conjunction with the affinity of these two elements for some proteins such as transferrin, ceruloplasmin and ferritin [V8]. These studies revealed changes in gene expression and protein carriers of iron, DMT1 (Divalent Metal Transporter Type 1) and Fpn (ferroportin), in the liver and kidneys [B19]. A similar study [D19] performed on rats chronically exposed to uranium in drinking water (2.7 mg/kg/day) showed the appearance of iron granules (aggregates) in the kidneys, indicating that chronic contamination by uranium could cause long-term changes in the regulation of iron metabolism. A recent study using surface plasmon resonance techniques has shown a strong affinity of fetuin-A protein for uranyl ions even though this protein is present in a very small amount [B7].

## 4. Conclusion

134. The kidneys are known as the most sensitive target organ after acute exposure, on the basis of well-documented studies. Studies on rodents (mice and rats) indicated that injury to the kidneys occurs from 0.1 mg/kg whole body and renal concentrations of  $>3 \mu\text{g/g}$ , targeting the third segment of the proximal convoluted tubule. Conversely, data on chronic exposure to low uranium doses are more recent and have not shown clear nephrotoxic effect at 2–20 mg/kg and no specific biomarkers have been identified to date. New blood plasma or urinary biomarkers of the renal function or integrity have been investigated in experimental or clinical studies, with a view to allowing a precise diagnosis of the kidney function [G27]. Mitochondrial dysfunction seems to be involved in toxic mechanisms of uranium, but the mechanisms of its toxicity are not fully elucidated to date, especially after chronic exposure to low and high doses. Further experimental studies are necessary for a better comprehension of the renal alteration process and the identification of more specific biomarkers of kidney alteration.

135. Chemical effects on the kidneys are usually assumed not to occur below certain threshold concentrations of uranium; most often, these findings have been derived from animal experiments with the appropriate safety factors applied to human exposure [A31]. Maximum concentrations over 3 µg of uranium per gram of kidney have been used as the basis for occupational exposure limits (e.g. [H20, L21]). Leggett [L21] suggested that the occupational limit based on 3 µg of uranium per gram of kidney is about tenfold too high for non-occupational exposure. Indeed, some human studies suggest that damage to the kidneys can be detected following chronic exposure that results in uranium concentrations as low as 0.1 µg per gram kidney [R28]. Thorne and Wilson [T9] suggested 30 µg U/kg kidney as a level below which effects will not be observed. Further, following a review of the existing literature, Leggett et al. have recommended that “the concentration of uranium in the kidney should not exceed 1 µg U/g kidney at any time” [L25].

## C. Bone

### 1. Acute exposure

136. Several animal experiments demonstrated a high uranium accumulation in bones of rats and dogs [A23, A24, P31]. Several studies performed on rats have investigated the effects of uranium on bone physiology. These studies found an impairment of bone growth and bone formation [P33, U1, U2]. These effects were associated with inhibition of endochondral ossification in mice [B45] and in rats [D15]. Other rat experiments indicated that uranium induced ultra-structural alterations in osteoblasts [T3]. An acute high dose of uranyl nitrate also delayed both tooth eruption and development in rats [P33]. However, the retardation observed seven days after acute uranyl nitrate exposure was reversed completely after 27 days [P34].

137. The *in vivo* results were confirmed in *in vitro* studies that showed that human osteoblasts were sensitive to uranium effects (increased reactive oxygen species production, decreased alkaline phosphatase activity, modified osteoblast phenotypes, genomic instability) [M38, M39, M42, T3]. An increase in oxidant stress shown by an increased lipid peroxidation was also observed *in vivo* in rat bone at high doses [G8].

### 2. Chronic exposure

138. On the basis of measured tissue concentrations and organ weights [F4, F8, L22, W26], bone tissue may contain up to 66–75% of the body burden of uranium following chronic exposure to uranium.

139. Several rat studies were designed to determine the uranium content of bones following chronic contamination [A24, P3, R18]. Rodrigues et al. showed that accumulation of uranium in the rat skeleton following intake via food increased to reach a plateau after one month [R18]. A long-term study of Paquet et al. demonstrated that uranium accumulation in bones increased until 18 months [P3].

140. Some experiments investigated the long-term accumulation in bones of young male rats (between the weaning and the post-puberty periods) [A23, R18]. Experiments performed on females during the growing period indicate that concentration of uranium in the animals’ femora increased faster in the early stages of the animal life, then saturating in adult animals.

141. Contamination of growing rats with uranium in food led to accumulation in bones (0.1–1.1 µg U/g bone) that exhibited the same pattern as the skeleton growing curve. Despite this accumulation, there was no change in the bone mineral density (BMD) [R18]. However, uranium exposure of adults led to a decrease in the BMD.

142. In contrast, a study of chronic exposure of growing rats to natural uranium for nine months via daily oral ingestion (uranium-contaminated drinking water at 40 mg/L) affected the skeleton by decreasing messenger RNA (mRNA) expression of genes involved in bone metabolism and decreasing femoral cortical bone area, while no changes were observed in adult rats [W1]. Chronic contamination by subcutaneous implantation of powdered uranium dioxide (125 mg/kg) in rats resulted in an inhibition of bone formation as has also been described for acute poisoning with uranium [D15].

143. Bone metabolism was investigated in human populations receiving high levels of uranium via drinking water by measurements of biochemical indicators of bone formation (osteocalcin and amino terminal propeptide of type I procollagen) and a marker for bone resorption (serum type I collagen carboxy-terminal telopeptide (CTx)) [K27]. The authors showed an elevation of CTx and osteocalcin that could be associated with increased uranium exposure.

### 3. In vitro studies: mechanisms

144. The cytotoxic effect of uranium on rat and human osteoblasts is highly dependent on its speciation. Exposure to non-toxic doses or non-toxic species of uranium induces the activation of two markers of bone formation and mineralization (osteocalcin and bone sialoprotein), while their inhibition is observed after toxic exposure [M37, M38]. This study highlights the importance of a controlled speciation of uranium in toxicological studies.

145. In vitro transcriptomic studies performed on several human cell lines taken from kidneys or lungs as representative targets have highlighted the involvement of osteopontin in the uranyl toxicity mechanisms [P29]. This major non-collagenous protein involved in the organo-mineral homeostasis of the bone presents a specific composition in acidic clusters associated with numerous phosphorylations, and also a relative plasticity. Qi et al. showed with in vitro models that native phosphorylated osteopontin binds uranyl with a nanomolar affinity and that this binding induces conformational changes enabling the formation of a very stable complex of uranium [Q1].

### 4. Conclusion

146. In conclusion, acute and chronic exposure to uranium-induced biological effects on bone metabolism such as the impairment of bone growth and of bone formation and the inhibition of endochondral ossification or the delay of development. Most effects were observed in experimental models (rodents or isolated humans cells). One study performed on humans exposed to high levels of uranium in drinking water showed an elevation of type 1 collagen carboxy-terminal telopeptide (CTx), a plasma marker for bone resorption, and of osteocalcin, indicator of bone formation [K27]. All these studies—in animals and humans—suggest that uranium affects bone turnover. Osteoblasts appeared to be the main cell targets of uranium. Some effects were also observed in humans, indicating that bone may be a target of uranium chemical toxicity in humans.

## D. Lungs

### 1. Acute exposure

147. In general, the more soluble compounds (uranyl fluoride, uranium tetrachloride, uranyl nitrate) are less toxic to the lungs but more toxic to distal organs due to easier absorption of the uranium from the lungs into the blood and systemic transport [G1].

148. The behaviour of uranium in the lungs following inhalation has been studied in animal experiments from various industrial settings [A31, C30, C31, D3, E3, S35, S38, S39, S40, W19, W20]. These studies demonstrated that the behaviour of uranium, its distribution, and its clearance in lungs is dependent on the solubility of uranium compounds. Results of these experiments were used to confirm or improve the ICRP models as described in chapter V on biokinetics.

149. Concerning the clinical effects of uranium in the respiratory system, authors reported alveolar fibrosis in rats [M60], congestion and haemorrhage in rats and guinea pigs [L19] and bronchopneumonia in rats and rabbits [D36] for uranium levels of between 10 and 100 mg/m<sup>3</sup>. The comparison of repeated and acute uranium exposure via inhalation was performed in rats [M55] with aerosols varying from 116 to 375 mg/m<sup>3</sup>. The results showed that UO<sub>2</sub> repeated pre-exposure by inhalation increased the genotoxic effects of UO<sub>4</sub> inhalation, when UO<sub>4</sub> exposure alone had no effect. However, it is not clear if these effects were due to a potentiation of the effect of UO<sub>4</sub> by pre-treatment with UO<sub>2</sub> or to a cumulative effect of the two types of exposure.

### 2. Chronic exposure

150. Experimental studies performed on dogs, monkeys and rats with uranium show that inhalation of natural uranium dioxide (UO<sub>2</sub>) at a mean concentration of 5 mg U/m<sup>3</sup> for periods as long as five years led to pulmonary neoplasia and fibrosis [L18]. Pulmonary neoplasia developed in a high percentage of the dogs examined two–six years after exposure. Pulmonary and tracheobronchial lymph node fibrosis, consistent with radiation effects, was dose dependent and more marked in monkeys than in dogs.

151. Nose only inhalation in rats showed that chronic inhalation of natural uranium ore dust (without significant radon content) created a risk of primary malignant and non-malignant lung tumour formation [M49]. The frequency of primary malignant lung tumours was 0.016, 0.175 and 0.328 and primary non-malignant lung tumours 0.016, 0.135 and 0.131 in the control, low (19 mg/m<sup>3</sup> leading to an absorbed dose of 0.87 Gy) and high (50 mg/m<sup>3</sup> leading to an absorbed dose of 1.64 Gy) aerosol exposed groups, respectively, without difference in tumour latency between the groups. Despite lymph node specific burdens ranging from 1 to 60-fold greater than the specific lung burden in the same animal, no lymph node tumours were observed.

### 3. In vitro studies: mechanisms

152. Inhalation of soluble uranyl nitrate led to uranium uptake in the lysosomes of alveolar macrophages and precipitation in the form of insoluble phosphate [B20]. A study by Lizon and Fritsch on alveolar macrophages with uranium concentrations from  $5 \times 10^{-5}$  to  $10^{-3}$  M showed that the toxicity of uranium was concomitant with the presence of insoluble forms in the culture medium [L40].

153. Orona and Tasat analysed rat alveolar macrophages to better understand the pathological effects associated with DU inhalation, metabolic activity, phagocytosis, genotoxicity and inflammation [O6]. The effects of 12.5–200  $\mu\text{M}$  DU seemed to be dose-dependent, most observed from 100  $\mu\text{M}$ . At low doses, DU induced phagocytosis and at high doses, provoked the secretion of  $\text{TNF}\alpha$ . Apoptosis was induced through the whole range of doses tested. The uranium-induced  $\text{TNF}\alpha$  secretion by macrophages was consistent with results from previous studies [G5, Z11]. Lung fibrosis was correlated with abnormal expression of  $\text{TNF}\alpha$  and IL-6, which could be antagonized by antibodies against  $\text{TNF}\alpha$  [Z11, Z12].

154. Orona and Tasat suggested that at low doses (12.5  $\mu\text{M}$ ), DU induced  $\text{O}_2^-$ , which may act as the principal mediator of DNA damage, while at higher doses (200  $\mu\text{M}$ ), the signalling pathway mediated by  $\text{O}_2^-$  may be blocked, and the prevailing DNA damage would be by  $\text{TNF}\alpha$  [O6]. A study by Monleau et al. indicated that exposure to DU by inhalation resulted in DNA strand breaks in broncho-alveolar lavage cells and in an increase in inflammatory cytokine expression and production of hydroperoxides in lung tissue [M56].

155. In addition to effects on pulmonary macrophages, a study showed that uranium (from 0.25 to 1 mM) induced significant oxidative stress in rat lung epithelial cells followed by a concomitant decrease in the antioxidant potential (glutathione and superoxide dismutase) of the cells [P13]. Further, some publications indicated that not only soluble (uranium acetate) but also particulate (uranium trioxide) uranium induced concentration-dependent cytotoxicity in human epithelial cells [W22].

156. Depleted uranium was clastogenic and induced chromosomal aberrations after 48 hours [L4]. Xie et al. [X1] found a loss of contact inhibition of these cells after particulate DU exposure, with chromosome instability and a change of cell phenotype, suggesting a neoplastic process.

## 4. Conclusion

157. Experimental acute and chronic studies demonstrated possible effects of uranium on fibrosis and tumour formation in lungs. Data obtained in vitro indicated the induction of genotoxic lesions (DNA strand breaks) and activation of inflammatory pathways on alveolar macrophages with high uranium concentrations. However, these underlying mechanisms were not investigated in vivo, limiting the relevance of these molecular effects to understand the link between uranium exposure and observed pathologies (fibrosis and tumour formation).

## E. Liver

158. Accumulation of uranium was observed in the liver of rats after injection, implantation or oral administration (uranyl nitrate) but at a lower concentration than in the kidneys for the same level of exposure [C35, P3, P11]. Acute exposure led to decreased liver weight and increased plasma transaminase levels, both indicators of liver hepatotoxicity in rats [G24, M57, O7] and in mice [O11].

159. More recently, some results were published on hepatic effects of uranium following in vivo exposure of rats [D29, G29], which demonstrated that some enzymes of xenobiotic metabolism, notably the cytochrome P450 of type 3A (CYP3A), were modified by chronic contamination with DU. The time-course study performed at 1, 3, 6, 9 and 18 months after exposure indicated that significant changes were observed at six and nine months [G29], with a 50% decrease in the mRNA level of



CYP2C11 at six months and an increase in gene expression of CYP3A at nine months. Concerning the dose–response study, the most substantial effects were observed in the liver of rats after nine months of exposure to 120 mg/L: CYP3A gene and protein expression and enzyme activity all decreased by more than 40% [D29, G29].

160. Several studies investigated the functional consequences of a co-exposure to uranium (uranyl nitrate) and the drugs chlorzoxazone [C26, M57], ipriflavone [C25], theophylline [Y4] or paracetamol [G27, R25] in rats. Altered drug pharmacokinetics was observed with high dose and chronic low dose exposure to uranium, which could be due to liver dysfunction. Functional toxicity of uranium was also estimated by measuring xenobiotic detoxification enzymes and their gene expression levels, protein levels or enzyme activities. Some studies reported altered levels of xenobiotic detoxification enzymes [G27, P6] while others reported altered pharmacokinetic metabolism of certain drugs after acute [C25, C26, M57] and chronic exposure to uranium [G27]. Oxidative stress may also occur in hepatocytes exposed to uranium, as demonstrated by mitochondrial or lysosomal alterations [P26] or metallothionein involvement [M47].

161. Chronic contamination with DU (uranyl nitrate, 1 mg/rat/day for 9 months) affected cholesterol metabolism in the rat liver [R2]. Relative mRNA levels of the enzyme cholesterol storage were modified, and also the proteins involved in the transport and the regulation of cholesterol homeostasis. One accident involving workers with extensive skin exposure to uranium has been reported in the literature [L48, S16, S49]. These results were similar to observations from the clinical follow-up of workers with acute uranium compound intoxication. Toxic hepatitis occurred for several days post-accident with recovery one month later [S16]. The result of 33-year follow-up showed that liver functions were normal [S49]. In conclusion, experimental studies performed in rats indicated that uranium exposure induced some biological effects on the liver, without a high uranium accumulation in this organ. These biological effects did not lead to the appearance of pathologies in animals. However, in humans, one study reported a transient toxic hepatitis.

## F. Brain

### 1. Behavioural effects

162. Adult rats exposed to uranium showed subtle but significant behavioural changes. Increases in locomotor activity, in line crossing and in rearing behaviour were observed after exposure of rats to DU in drinking water at 2 or 4 mg/kg per day or after inhalation [B52, M54]. Females seemed to be more resistant: unlike males, they did not show locomotor symptoms [B51]. Exposure to uranium to 0.1, 0.3 or 1 mg uranium/kg also affected working memory with poorer performance (decreased latency) in a light–dark passive avoidance response system [B6]. The spatial working memory measured by the percentage of spontaneous alternation was significantly lower after exposure to DU by inhalation and after ingestion of 1 mg per day of 4% enriched uranium [H24, H25, M54]. Lastly, exposure at this dose of enriched uranium had a deleterious effect on anxiety and increased the amount of rapid eye movement in sleep [H24, H25, H26]. However, DU had no significant effect in the same experimental conditions [H24, H26, L30]. A recent review summarized the different effects of uranium on behaviour. It can lead to neurobehavioural impairments, including increased locomotor activity, perturbation of the sleep–wake cycle, decreased memory, and increased anxiety. The mechanisms underlying these neurobehavioural disturbances are not clearly understood [D16].

163. Mouse experiments were conducted on ApoE<sup>-/-</sup> mice that had been genetically knocked out for the apolipoprotein E gene, the product of which regulated cholesterol metabolism. These mice had hypercholesterolemia and expressed biochemical markers of Alzheimer's disease. Administration of DU to these mice resulted in impaired memory compared to unexposed ApoE<sup>-/-</sup> mice [L33]. This cognitive effect was associated with a trend toward higher total cholesterol content in the cerebral cortex (+15%). This study demonstrated that some pathological conditions may increase sensitivity to uranium. Table 12 summarizes the main studies on animal behaviour after uranium exposure.

Table 12. Summary of studies of uranium exposure on rodent behaviour

im: intramuscular; DU: depleted uranium; EU: enriched uranium

<i>Uranium compound</i>	<i>Species</i>	<i>Exposure conditions</i>	<i>Main biological effects</i>	<i>Reference</i>
Uranyl acetate	Adult rat	2 and 4 mg/kg/day (water) DU during 2 weeks and 6 months	Increased locomotor activity	[B52]
Uranyl nitrate	Adult rat	2.5, 5 and 10 mg/kg/day (water) DU during 3 months	Increased locomotor activity, decreased spatial memory	[B11]
Uranyl dioxide	Adult rat	Inhalation DU 30 min at 197 mg/m <sup>3</sup> , 4 days a week for 3 weeks	Increased locomotor activity and decreased spatial memory one day post-exposure	[M54]
Uranyl acetate	Adult rat	im. 0.1, 0.3 and 1 mg/kg DU	Decreased locomotor activity, decreased grip strength, decreased working memory at 6, 13, 20 and 27 days post-dosing	[B6]
Uranyl nitrate	Adult rat	1 mg/kg/day (water) 4% enriched uranium (EU) during 1.5 months	Decreased spatial memory, increased of anxiety	[H25]
Uranyl nitrate	Adult rat	1 mg/kg/day (water) 4% EU during 1.5 months	Increased paradoxical sleep	[L29]
Uranyl nitrate	Adult rat	i.p. 144 µg /kg 1 and 3 days	No change in sleep-wake cycle	[L30]
Uranyl nitrate	Adult rat	1 mg/kg/day (water) 4% EU during 3 or 9 months	Decreased spatial memory	[H24]
Uranyl acetate	Fetal mouse	1, 2 and 4 mg/kg/day DU during gestation and lactation	Accelerated appearance righting reflex, forelimb placing, grasping, swimming and weight gain	[B50]
Uranyl acetate	Young mouse	1, 2 and 4 mg/kg/day (water) DU during 21 days since the birth	Decreased locomotor activity, decreased working memory	[B51]
Uranyl acetate	Fetal rat	10, 20 and 40 mg/kg/day (water) DU during 3 months (male)	Decreased learning in pups	[A10]
Uranyl nitrate	Adult rat	1 mg/kg/day (water) DU during 2 months since the birth	Decreased spatial memory	[B15]
Uranyl nitrate	Adult mouse (ApoE <sup>-/-</sup> )	4 mg/kg/day (water) DU during 3.5 months	Impaired memory	[L33]

## 2. Neurotransmitters

164. Several experimental studies suggest that uranium can induce changes in neurotransmitter levels: acetylcholine levels were unchanged in the hippocampus after exposure to 1 mg DU per kg and day but were decreased in the cortex [B14]. Chronic DU contamination induced a fall in the rate of acetylcholine (ACh) and AChE activity in the entorhinal cortex and cerebellum [B15, B55]. This disturbance of cholinergic function was associated with a decrease in gene expression of several proteins [B14]. These studies suggest that the modifications of neurobehavioural tasks following uranium exposure could be linked with a change of AChE activity in the cerebral cortex [B52].

165. A study performed in Sprague-Dawley rats (following 1.5, 6, or 9 months with 2.7 mg U/kg per day) reported that AChE activity was not significantly affected in the striatum, hippocampus, or frontal cortex at any time point, but it was significantly decreased in the cerebellum at six months [B55]. Depleted uranium exposure at 2.7 mg/kg per day also induced a significant decrease in AChE activity in the striatum and cerebral cortex [B14, B55]. A dose–response study performed at nine months following chronic contamination indicated that uranium effects (15% decrease in AChE activity) were independent of uranium content in drinking water (from 0.2 to 120 mg/L).

166. A 1.5-month ingestion of 1 mg U/kg per day increased the dopamine level in the hypothalamus [B55]. Chronic exposure produced a significant decrease in the serotonin (5HIAA) level and the serotonergic (5HT-ergic) turnover ratio in the frontal cortex and also a decrease in the dopamine (DOPAC) level and dopaminergic (DA-ergic) turnover ratio in the striatum [B55]. It appeared that disruption of these systems differed depending on the brain structure considered, the time of exposure and the degree of uranium enrichment [A1, B14, B55, L29].

## 3. Oxidative stress

167. One specific mechanism by which uranium leads to neuro-effects could be oxidative stress. The behavioural changes correlated with lipid peroxidation in the brain induced by uranium [B52, G8]. The gene expression or enzymatic activity of the main antioxidant enzymes, i.e. superoxide dismutase, catalase and glutathione peroxidase, increased significantly in the hippocampus and the cerebral cortex after exposure to DU and decreased after exposure to 1 mg of 4% enriched uranium per kg per day [L31, L38]. The cell response to DU could be interpreted as a defensive mechanism towards free radical damage to cerebral tissue (increase of several antioxidant agents in order to counteract the oxidative stress). The oxidative stress induced by the enriched uranium is possibly too high to be counteracted by the cell defences.

168. A dose–response study performed nine months after chronic contamination with DU from 0.2 to 120 mg/L indicated that uranium affected the activity of these enzymes differently (diminution for SOD and increase for GPx or Catalase). The gene expression of inducible nitric oxide synthase, the enzyme that synthesizes nitric oxide, increased significantly after chronic exposure to 1 mg DU per kg and day [L38]. Repeated administration of DU as uranyl acetate during seven days also increased the nitrite levels in the brains of rats [A1].

## 4. Exposure of developing animals

169. In rodents, exposures at 1, 2 or 4 mg DU/kg per day during development accelerated the appearance of several types of behaviour: righting reflex (for example, when the rat is put on its back, it turns over immediately), placing reactions (for example, the rat is held by the tail over a table until its whiskers get near, when it puts its paws on the table), grasping (the rat is picked up and the palm is touched with a wire and the response is to grip the wire), swimming and weight gain [B50].

170. Animals exposed to uranium at 1, 2 or 4 mg U/kg per day during development had a decreased locomotor activity [B51] and their performance was worse on a test of working memory [B15]. The spatial learning of the offspring of uranium-exposed male rats at 1, 2 or 4 mg U/kg per day for learning was also affected [A10]. A dose–response study (0, 10 or 40 mg/L of uranium in drinking water) indicated no significant uranium effect on behaviour at 10 mg /L, and an impairment of object recognition memory (–20%) at 40 mg/L [L32].

171. Neurogenesis processes during pre- and postnatal brain development were studied in rats by investigating the structural morphology of brain, cell death and cell proliferation after chronic exposure to drinking water contaminated with uranium (40 and 120 mg/L) [L26]. Major changes were observed at 120 mg/L, both during prenatal and postnatal periods. At the highest dose, DU caused opposite effects during brain development on cell proliferation and cell death processes, mainly between prenatal and postnatal development. These modifications did not have a major impact on brain morphology but they could affect the next steps of neurogenesis and disrupt the organization of the neuronal network.

172. Some studies were published on the comparative effects of depleted and enriched uranium in rats [H24, L31]. Chronic exposure to 4% enriched uranium for 1.5 months through drinking water increased the amount of paradoxical sleep, reduced the spatial working memory capacity and increased anxiety while no effect was observed following exposure to DU [H24]. These cognitive effects were associated with imbalance of oxidative stress [L31]. Indeed, lipid peroxidation was increased in brain after enriched uranium exposure but not after DU exposure. Enriched uranium induced a decrease of anti-oxidative enzymes, and DU induced an increase of these anti-oxidative enzymes.

## 5. Conclusion

173. Animal studies suggest that uranium can have some negative effects on the behaviour of mature animals that could be explained at a neurochemical level (neurotransmitters, oxidative stress) for highest doses. In addition, some results obtained in rats and mice demonstrate differential effects between depleted and enriched uranium, suggesting the importance of the radiological toxicity of uranium. The data also suggest that the developing animal may acquire a specific sensitivity to uranium effects. In humans (workers or public), the correlation between behavioural symptoms and exposure to uranium was not demonstrated. Thus, data obtained in animals are only suggestive until they can be tied to meaningful human research.

## G. Reproduction and development

### 1. Female reproductive function

174. Results for measurements of uranium concentrations in gonads were contradictory depending on the study (species, administration pathway, uranium dose and exposure time). In fact, high uranium accumulation is found in some fish and birds. For instance, significant uranium accumulation was measured in female fish gonads (*Danio rerio*), corresponding to >20% of the relative burden [S20].

175. A dose-dependence of uranium concentration in ovaries was measured in rats and their offspring after chronic oral exposure via food [H9, H10]. The accumulation of uranium was higher in the second exposed generation. Other experimental studies performed on mice failed to report uranium accumulation in the ovary after contamination by nitrate uranyl with doses up to 400 mg/L for uranium content in drinking water [A21, F2, R9].

176. Some studies found that uranium affected oocyte quality *in vivo* with a 50% reduction in the proportion of healthy oocytes from 20 mg/L [F2] and germinal vesicle oocytes cultured *in vitro* in the presence of 1 mM uranyl acetate and observed for 72 hours [A21]. *In vivo*, these morphological effects were observed from uranium content in drinking water above 5 mg/L [F2]. A study with similar approaches (uranium ingestion via drinking water in mice) indicated similar results, with increased dysmorphism of oocytes in contaminated groups (from 2.5, 5 and 10 mg U/kg per day chronically administered in drinking water for 40 days) in a dose independent manner [K24]. In addition, a study on mice contaminated *in utero* by uranium levels in drinking water from 0.5 to 60 µg/L, showed an increase in uterine weight and a decrease in primary follicles [R9].

177. Reproductive effects following chronic oral uranium exposure were observed in rats exposed during the first and the second generation [H10]. No effect were observed in F<sub>0</sub> rats, but pregnancy rate, normal labour rate, and survival rate were decreased in offspring [H10]. *In vitro* organ culture system was used to investigate the effects of uranium on human gonads during the first trimester of gestation (7–12 weeks) [A13]. Uranium at 0.05 mM increased the apoptosis rate, decreasing the germ cell density of human fetal ovaries. The authors also demonstrated that human fetal germ cells were more sensitive to uranium than mouse germ cells.

### 2. Male reproductive function

178. Some animal studies indicated accumulation of uranium in testes with 0, 5, 10, and 25 mg/kg/day of uranyl acetate dehydrate before mating and up to 21 days post birth [P7]. A linear dose-dependence was found in testes of Japanese quail, with a ratio of accumulation similar in testes and in kidney [K25]. A dose-dependence of uranium concentration in testes was measured in rats and their offspring after chronic oral exposure via food [H10]. The accumulation of uranium was higher in the second generation.

179. Concerning the effects of DU on sex hormone levels, experimental studies performed in male rats showed differing results. One experiment performed in male rats indicated an increase in testosterone and luteinizing hormone levels and a decrease in follicle stimulating hormone level after a four-month contaminated food ingestion [H10], while a nine-month contaminated drinking water ingestion did not lead to changes in testosterone and 17β-estradiol levels [G20]. The different uranium doses 4 and 40 mg/kg per day in the studies of Hao et al. [H10], and 2.7 mg/kg per day in the study of Grignard et al. [G20] were used to explain the different levels. However, changes in testosterone levels were not

observed in depleted-uranium Gulf War veterans [M19, M20]. A nine-month chronic oral exposure to enriched uranium produced a significant increase in the blood levels of testosterone at 40 mg/L in drinking water, while no effect was observed with DU [G20].

180. Some reports on rodents highlighted a negative impact of uranium on male reproductive function, including a decrease in male fertility and in the spermatid number per testis with a few histopathological effects on the seminiferous tubules and interstitium after chronic exposure [L37, L41]. Although some abnormal morphological forms and sperm parameters measured were affected by uranium exposure, these changes were independent of the uranium dose levels from 10 to 40 mg/kg per day corresponding to ~200 to 800 mg/L in drinking water, respectively [L37]. Further, a dose-independent decrease in the pregnancy rate was observed in untreated females mated with male mice exposed to between 10 and 80 mg/kg per day of uranium [L41].

181. Implantation of DU pellets did not change the concentration, motion and velocity of sperm, and there is no evidence of detrimental effects of uranium on mating success, suggesting that implantation of up to 20 DU pellets of 1×2 mm (760 mg) in rats did not have an adverse impact on male reproductive success, sperm concentration, or sperm velocity [A19]. Testicular histopathological abnormalities with deformations of seminiferous tubules (marked reduction in the seminiferous tubule diameter) were observed in mice after high acute exposure [J1]. A seven-day daily intraperitoneal administration of uranyl nitrate (0.5 mM/kg) induced a marked reduction in the seminiferous tubule diameter and gametogenic count, with signs of testicular necrosis and exfoliation of germ cells, including karyolysis and karyorrhexis figures.

182. The contribution of new in vitro models, such as organotypic culture systems, helps the understanding of the underlying action mechanism of chemicals. This approach was used as a toxicological test to evaluate the effects of various compounds, including uranium, on gametogenesis and steroidogenesis in rat, mouse and human testes [H1]. Some effects on germ cell development (reduction of the number of germ cells) or Leydig cell function were observed for uranium concentrations above  $5 \times 10^{-5}$  M in human testis cells and above  $5 \times 10^{-4}$  M in rat testis cells [A13].

183. Uranyl fluoride injected in vivo into mouse testes led to an increase in the frequency of chromosomal aberrations in spermatogonia and primary spermatocytes [H27]. These results were confirmed in another study that indicated the highest effects when doses of  $\text{UO}_2\text{F}_2$  increased up to 6 mg/kg at 12 days post-exposure [H28]. A study performed with enriched uranium demonstrated chromosome aberrations in spermatogonia [Z15]. Chromosome fragmentation, translocation, polyvalence in primary spermatocyte and DNA strand breakage were observed in sperm. Effects of uranium on human male reproduction studied in Gulf War I veterans did not evidence deleterious effects on sperm quality, including volume, concentration, total sperm count, and functional parameters of sperm motility [M20, M21, M22].

### 3. Effects on embryos and development

184. The effects of uranium on embryotoxicity were studied in rats and mice after acute exposure [D17]. Subcutaneous injections of uranyl acetate dihydrate (0.5, 1 and 2 mg/kg/day) in mice from day 6 to day 15 of gestation induced various effects [B44]. Although it was not dose-related, embryotoxicity also occurred in all uranium-treated groups (significant increases in the number of non-viable implantations and in the percentage of postimplantation loss). Both the maternal NOAEL and the NOAEL for embryotoxicity of uranyl acetate dihydrate were below 0.5 mg/kg/day, whereas the NOAEL for teratogenicity was equal to 0.5 mg/kg/day.

185. Few animal studies investigated the effects of uranium exposure on development and results were conflicting, depending on the quantity of administered uranium and the exposure duration. Subcutaneous injections of uranyl acetate dihydrate from day 6 to day 15 of gestation induced malformations detected at 1 and 2 mg/kg/day in mice [B44], while no effect was observed at 0.5 mg/kg/day.

186. Paternain et al. demonstrated that embryo lethality could be observed in mice contaminated at 25 mg/kg/day [P7]. Significant increases in the number of dead young per litter were seen at birth and at day 4 of lactation in the 25 mg/kg/day group. The growth of the offspring was always significantly lower for the uranium-treated animals. Since no effect was observed at lower doses (5 and 10 mg/kg/day), the results suggest that uranium does not cause adverse effects on fertility, general reproductive parameters, or offspring survival at the concentrations usually ingested by man.

187. In vitro studies were also conducted on one-cell mouse embryos in culture medium with uranyl nitrate at concentrations of 26, 52, 104 and 208 µg/mL [K23]. The results obtained showed that concentrations from 26 µg U/mL induced the delay of embryo development and the impairment of blastomere proliferation. A study of acute toxicity was performed in mice receiving 4 mg/kg of DU per intraperitoneal injections (i.p.) at day 11 of gestation and observations were made 4 days later. Paradoxically, the authors found an increase in the fetus length and weight [M46].

188. Subcutaneous injections of uranyl acetate (0.415 and 0.830 mg/kg/day) were given to pregnant rats on days 6 to 15 of gestation [A9]. Maternal toxicity and embryotoxicity were noted at the higher dose, while fetotoxicity was evidenced at both doses. The fetotoxicity was evidenced by significant reductions in fetal body weight and increases in the total number of skeletal abnormalities [A9].

189. Some studies indicated developmental toxicity of uranium, including teratogenicity, following an acute subcutaneous administration of 1 or 2 mg/kg/day [B44, D18]. A study by Zhu et al. [Z15] was performed with enriched uranium injected in rat testes, causing skeletal abnormalities in fetal rats with a positive correlation to the injected dose.

190. Hereditary effects of uranium were investigated in rats following the implantation of uranium pellets in muscle (up to 12 DU pellets corresponding to 360 mg) [A20]. This study indicated no changes in sperm motility and ribcage malformations, suggesting that uranium was not a significant reproductive or developmental hazard. This study is in accordance with another study that indicated that uranium did not cause any adverse effects on fertility, general reproductive parameters, or offspring survival at the concentrations usually ingested by humans [P7]. One study performed on mice investigated the transmission of genetic damage to offspring of fathers contaminated with uranium via depleted-uranium-implanted pellets [M45]. The authors demonstrated a dose-dependent increase in mutation frequency in the offspring. Congenital malformations [A6, A7, S48] or birth defects [A3, B54, F1] were reported in some human populations, but these effects were not correlated to a quantification of uranium exposure.

#### 4. Conclusion

191. Some publications focused on reproduction and development issues after exposure to uranium in animals (rats and mice). These studies indicated that both male and female reproductive functions (quality of oocytes and sperm parameters, embryo viability, and the development processes) may be affected by acute and chronic exposure. However, these effects were observed for exposure levels greater than either typical occupational or environmental levels of exposure.

## H. Other organs

### 1. Skin

192. A study of acute exposure of rabbits was conducted using different administrations of uranium oxide: subcutaneous deposit of ~30 mg  $U_3O_8$ ; cutaneous deposit of 70 mg of  $U_3O_8$  or 5  $\mu$ g of uranium acetate (1.9 kBq of  $^{233}U$ ) [W3]. Uranyl nitrate, in ethereal or aqueous solution, produced a superficial coagulation necrosis within a few hours [O4]. A similar but delayed effect was seen seven–nine days following the application of powdered hygroscopic uranium pentachloride to the skin. Uranium tetrachloride in suspension in lanolin caused a moderate local erythema of the skin at the site of application, which disappeared in one–two days.

193. In vitro studies on primary cultures of rat skin keratinocytes and fibroblasts [P15] showed a greater decrease in proliferation rate associated with a greater mortality rate in rat skin keratinocytes than in rat skin fibroblasts after uranium exposure. This can be explained by the three times higher ability of keratinocytes to incorporate uranium compared to fibroblasts. This greater capacity of epidermal cells than dermal cells to incorporate uranium was confirmed in vivo in hairless rats following topical contamination with uranyl nitrate.

194. The consequences of protracted exposure to uranium were investigated using guinea pigs and rabbits [O4]. Guinea pigs that were repeatedly exposed to uranyl nitrate exhibited a superficial coagulation necrosis and an inflammation of the epidermis. Their skin was in a constant state of encrustation and desquamation accompanied by rapid regeneration from beneath. Rabbits that were repeatedly exposed at multiple dermal sites exhibited an effect similar to that seen after single acute exposure, but those rabbits that were repeatedly exposed at the same site developed severe dermal ulcers after five to ten applications of the compound. Another in vivo study in rats revealed that long-term exposure of the dermis to uranium ( $U_3O_8$  at 0.012 g/d for 30 daily topical applications) led to an epidermal atrophy which, in turn, resulted in an increased permeability of the skin [U2].

### 2. Endocrine system and metabolism

195. Vitamin D is essential for the homeostasis of calcium and phosphorus in the body. A few studies have determined the effects of acute or chronic uranium contamination on the metabolism of vitamin D in rats. Contamination by DU via drinking water at 40 mg/L [T11] induced a decrease in the blood levels of vitamin D in rats following a nine-month chronic exposure. Moreover, uranium targeted key transcription factors (PPAR $\alpha$ , PPAR $\gamma$ , HNF-1 $\alpha$ , HNF-4 $\alpha$ , LXRR, RXR $\alpha$ , and VDR) involved in this metabolism [T11, T12]. However, these molecular changes did not lead to the emergence of disease associated with vitamin D metabolism.

196. Chronic contamination by DU (uranyl nitrate, 2.7 mg/kg/day for 9 months) affected cholesterol metabolism in the liver and brain [R1, R2], mRNA levels of the enzymes involved in the cholesterol storage were modified in the liver and brain, and mRNA levels of enzyme involved in the cholesterol synthesis were modified in the brain. Uranium also affected the proteins involved in the transport of cholesterol and the regulation of cholesterol homeostasis. Thus, a chronic ingestion of uranium



(40 mg/L in drinking water) caused subtle molecular effects on metabolism in the liver and brain of rats. However, overall cholesterol levels were unaltered in this study using 40 mg/L uranium in drinking water.

197. Studies of rats exposed to uranium showed both disruptive effects on the reproductive system and estrogenic effects. Chronic contamination with DU (560 Bq/L) in drinking water produced no change in the blood levels of the two principal steroid hormones—oestradiol and 17 $\beta$ -testosterone (synthesized by the testis), whereas contamination with enriched uranium (1,680 Bq/L; 40 mg/L) produced a significant increase in the blood levels of testosterone [G20]. Consistent with the absence of hormonal changes with DU, chronic contamination with DU did not induce a change of gene expression. However, the expression of enzymes involved in the metabolism of hormones was amplified following a nine-month exposure to enriched uranium. In addition, enriched uranium increased the gene expression of transcription factors (RXR, LXR, FXR, SHP, SF-1, DAX-1) that positively regulate steroid metabolism. These results show a differential effect of depleted and enriched uranium contamination on testicular steroidogenesis [G20].

198. The human body is frequently exposed to potentially toxic compounds and is able to metabolize them in order to protect itself. Xenobiotic-metabolizing enzymes, including cytochrome P450 (CYP450), play a central role [G25]. The kidneys and liver can metabolize many drugs or other xenobiotics. Disturbances of this system have been demonstrated *in vitro* [M43] and in rats exposed to nephrotoxic [M57] or non-nephrotoxic uranium concentrations [P6, S29]. These studies showed that the expression and activity of CYP450 can be modified by uranium exposure. The consequences of such modifications on xenobiotic metabolism were investigated using acetaminophen [G26]. Rats contaminated with DU presented slower plasma acetaminophen elimination and also more marked renal histological changes and an increase in blood markers of liver damage (at 40 mg/L during 9 months). However, only slight effects of uranium were reported on enzymes of xenobiotic metabolism when acetaminophen was administered to rats as a single therapeutic treatment [R25].

199. In conclusion, studies performed on animal models (rat and mouse) chronically exposed to radionuclides showed that the chronic ingestion of uranium resulted in subtle biological effects on various metabolic systems. These modifications did not lead to the appearance of pathologies, even for uranium levels in drinking water up to 40 mg/L. The observed biological effects probably resulted from an adaptive response to the internal contamination.

### 3. Immune and haematopoietic systems

200. Very few studies have investigated the effects of uranium exposure on the haematological system. Reduced erythropoiesis might be expected owing to accumulation of uranium in bone in proximity to bone marrow and renal damage might result in a decrease in the number of red blood cells. A study using rats found that chronic ingestion of uranium at 40 mg/L in drinking water for nine months led to kidney deterioration which may have been responsible for an observed decrease in the red blood cell count; there was an associated modification of spleen erythropoiesis and levels of molecules involved in erythrocyte degradation [B19].

201. A study by Giglio et al. was performed to assess the effect of uranium (uranyl nitrate) on the rate of erythropoiesis in rats [G9]. The authors showed that a single injection of uranium at 1 mg/kg induced a transient depression of the red cell volume between 7 and 14 days. These effects were associated with a decreased Epo production and direct or indirect damage of erythroid progenitor cells.

202. An experimental study using mice fed uranium-contaminated food [H11] compared the effect of concentrations of DU of 0, 3, 30 and 300 mg/kg feed for a duration of four months. The most significant effects were observed in the 300 mg/kg group while the effects were either minor or indiscernible in the other groups. At high dose, the authors observed decreased immune function, manifesting as decreased secretion of inflammatory mediators in the peritoneal macrophages, and also reduced cytotoxicity of the splenic natural killer cells. Moreover, the cellular and humoral immune functions were abnormal (decreased proliferation of the splenic T cells, proportion of the cluster of differentiation (CD) 3<sup>+</sup> cells, ratio of CD4<sup>+</sup>/CD8<sup>+</sup> cells and delayed-type hypersensitivity, and increased proliferation of the splenic B cells, total serum immunoglobulin (Ig) G and IgE, and proportion of splenic mIgM<sup>+</sup>mIgD<sup>+</sup> cells). The authors concluded that chronic intake of high doses of DU (300 mg/kg) had a significant impact on the immune function, most likely due to an imbalance in T helper Th1 and Th2 cytokines.

203. Studies on rats have addressed the effects of uranium exposure on the mucosal immune system of the intestine following ingestion of uranium-contaminated drinking water [D26, D27, D28]) and in lungs following inhalation [M54, M56, P6]. Studies performed on the rat intestine found that Peyer's patches (aggregated structures of gut-associated lymphoid tissue) were a site of retention of uranium following chronic ingestion (with uranium content in drinking water of 40 mg/L) after 9 months, without inducing any biological effects on the function of Peyer's patches [D26]. However, chronic ingestion of uranium (nine months at 40 mg/L in drinking water) led, in the long term, to some changes in the immune cell populations in lamina propria, diffuse gut-associated lymphoid tissue, notably increase in neutrophil number (+300%) and decrease in macrophage (-50%), and mast cell number (-30%) in rats [D28].

204. Dublineau et al. indicated that immune cell populations in the intestine (neutrophils, mast cells, macrophages) did not vary after 9 months of uranium exposure in rats, at any exposure level (from 0.2 to 120 mg/L in drinking water) [D29]. The authors observed an increase in mRNA levels of cytokines (IFN-gamma, IL-10, and CCL-2), at uranium levels in drinking water >20 mg/L, and a decreased protein expression of cytokines (IFN-gamma, IL-10, and TNF $\alpha$ ). Such effects may be explained by uranium interaction with proteasome [M6]. Changes in immune cell populations of the intestinal wall were not reported in the short term following acute contamination with a sublethal dose of uranium in rats (204 mg/kg of DU *per os*) [D27].

205. Immunological changes of long-term uranium exposure were investigated in mice fed with various DU doses (0, 3, 30 and 300 mg/kg food) [H11]. A four-month contamination of animals with 300 mg U/kg food led to a decreased secretion of nitric oxide, interleukin (IL)-1 $\beta$ , IL-18, and tumour necrosis factor (TNF)- $\alpha$  by the peritoneal macrophages, a decreased proliferation of the splenic T cells and increased proliferation of the splenic B cells associated with an increase in total serum immunoglobulin (Ig) G and IgE, and proportion of splenic mIgM(+)/mIgD(+) cells. Such effects were not observed for the lowest groups (3 and 30 mg U/kg food).

206. Some studies reported effects of uranium exposure on pulmonary immune cells following inhalation in rats [M54, M56, P6]. An uptake of uranium by pulmonary macrophages was found (phagocytosis), followed by an accumulation of uranium in lysosomes [B20, M61]. This accumulation was associated with release of pro- and anti-inflammatory cytokines *in vivo* [M54, M56] or *in vitro* [G5, W8, Z12]. Inflammatory cells were observed in proximity to aggregates of uranium particulates [L9]. This inflammatory cell response may lead to oedema and bronchial inflammation [B8, M59]. An induction of apoptosis was observed *in vitro* in macrophages and T lymphocytes (CD4<sup>+</sup>) [W8].

207. In the follow-up of United States veterans of the first Gulf War published by McDiarmid et al. [M25], the authors reported for the first time on the analysis of immune function in Gulf War I veterans

exposed to DU, investigating the lymphocyte response to stimulation by two T-cell mitogens. The results on released cytokines (IFN $\gamma$ , IL-10 and IL-2) in the high- and low-uranium exposure groups did not provide evidence of an effect of uranium on the immune cells.

208. Haematological parameters were recorded in some human populations exposed to uranium. Haematocrit, haemoglobin and RBC content from uranium processing site workers remained within the normal ranges [S10]. Haemoglobin concentrations, erythrocyte counts, haematocrit values, and mean corpuscular volumes were determined on a group of miners in a uranium mine [V6]. There were small differences of mean values from those of controls, such as diminution of haemoglobin concentrations and erythrocyte counts when uranium exposure time increased, but the mean values remained within normal limits. A clinical study of Gulf War veterans showed that soldiers exposed to uranium had a reduction in haemoglobin and haematocrit levels [S32].

209. In conclusion, it appears that slight modifications of the immune system, either systemic or mucosal (including intestines and lungs), were induced following uranium exposure only at high doses, at concentrations usually not incorporated by humans.

#### 4. Cardiovascular system

210. Few human data are available concerning uranium effects on the cardiovascular system. A study was performed on people who had used drinking water from drilled wells containing high levels of uranium (up to 1,500  $\mu\text{g/L}$ ) for several years. This study suggested that uranium exposure was associated with greater diastolic and systolic blood pressure [K28]. Two other studies were performed among residents living near the Fernald Feed Materials Production Center, which functioned as a uranium processing facility from 1951 to 1989 [P22, W2]. The systolic and diastolic mean blood pressure levels were higher for population groups living near this uranium plant than those found in the general population, and for most age- and sex-specific groups. However, neither distance nor direction from the site influenced the blood pressure measurement results, suggesting that these findings are not exposure-related [P22]. Another study showed similar results: women with higher uranium exposure had elevated systolic blood pressure compared to women with lower exposure, but the changes observed in diastolic blood pressure or hypertension were not related to exposure level [W2].

211. Concerning experimental studies, there is a lack of literature on the effect of uranium exposure on the development of cardiovascular diseases. One of the consequences of uranium-induced kidney disease could be adverse effects on the cardiovascular systems by a number of mechanisms, including changes to the renin-angiotensin pathway. Several publications have focused on the relationship between kidney and cardiovascular systems in humans [P1, R21, T2]. Consequently, the absence of relevant publications precludes demonstration of an obvious link between uranium exposure and induction of cardiovascular pathologies.

#### 5. Effects on DNA

212. Uranyl acetate staining of DNA has been used for staining fixed cells for more than forty years [H27]. In vitro studies performed with purified DNA showed the presence of a tight binding site for the uranyl ion ( $\text{UO}_2^{2+}$ ) in a four-way DNA junction [M53], demonstrating that uranium can be bound to DNA in vitro. Exposure to uranium may lead to inhibition of DNA-binding proteins [H15, V7]. In vitro studies demonstrated that uranium can displace transcription factor binding to DNA and that it can bind to serum proteins accumulation in the nucleus of human cells [H15, V7]. Experimental studies have

shown accumulation of uranium in the nucleus of human cells (renal, hepatic, neuronal cells) treated in vitro [G30, R26] and in kidney cells of rats treated in vivo [H23].

213. Depleted uranium can induce oxidative DNA damage [B3, K2, M40]. These studies suggested that DU could induce DNA lesions through interaction with cellular oxygen species. These results were corroborated by an in vivo study that showed that inhalation of DU resulted in a production of hydroperoxides in lung tissue of rats [M56]. A recent in vitro experimental study reported the formation of uranium–DNA adducts and mutations in mammalian cells after direct exposure to a compound of DU [S34]. The data suggest that uranium could be chemically genotoxic and mutagenic. The unique mutation spectrum in hypoxanthine-guanine phosphoribosyl transferase (HPRT) locus elicited by exposure to DU suggests that uranium-generated mutations in ways that are different from spontaneous, free radical and radiological mechanisms [C33].

214. Another study on rats demonstrated that UO<sub>2</sub> repeated pre-exposure by inhalation increased DNA single-strand breaks induced by a single UO<sub>4</sub> inhalation exposure in epithelial nasal cells, bronchoalveolar lavage cells and kidney cells, whereas a single inhalation exposure to UO<sub>4</sub> alone had no such effect [M55]. In vitro studies indicated that uranium-induced DNA single-strand breaks were catalysed in the presence of ultraviolet light or ascorbate [M53, N7, Y2]. In vivo [M54, M55] and in vitro [D5, T6] studies showed that uranium induced DNA double-strand breaks. An in vitro study demonstrated that DU was a weak clastogen<sup>2</sup> and induced aneugenic<sup>3</sup> effects while enriched uranium is a more potent clastogen [D5].

215. In summary, experimental studies performed in vivo in rodents or in vitro in cell cultures suggested that uranium could be chemically genotoxic and mutagenic through the formation of strand breaks and covalent uranium-DNA adducts.

## 6. Cytogenetic damage

216. Uranyl fluoride injected in vivo into mouse testes led to an increase in the frequency of chromosomal aberrations in spermatogonia (breaks and polyploids) and primary spermatocytes (fragments, chromatid exchanges, reciprocal translocations) [H27]. An in vitro study performed on human bronchial fibroblasts indicated no significant increase in chromosomal damage following chronic exposure to uranyl acetate and a slight increase following exposure to uranium trioxide [W22]. An increase in the frequency of sister chromatid exchange and in the frequency of chromosomal aberrations was also observed in cell lines [L36] and in human osteosarcoma cells [M41].

217. A study by Hao et al. using rats showed that chronic oral exposure to DU in food led to an increased frequency of micronuclei in bone marrow cells at 4 and 40 mg U/kg/day in weaning rats [H9]. Miller et al. investigated the transmission of genetic damage to offspring of males mice contaminated with uranium via depleted-uranium-implanted pellets. The authors demonstrated a dose-dependent increase in mutation frequency in the offspring [M45].

218. Chromosome aberrations in Gulf War I veterans following DU exposure were evaluated in several studies [A8, B2, M24, N6]. Four biomarkers of genotoxicity (micronuclei, chromosome aberrations, mutant frequencies of HPRT and PigA<sup>4</sup>) were examined. There were no statistically significant

<sup>2</sup> A clastogen is a mutagenic agent that induces disruption of chromosomes.

<sup>3</sup> An aneugenic agent promotes aneuploidy in cells during mitosis or meiosis leading to the presence of abnormal number of chromosomes in cells.

<sup>4</sup> PigA gene mutation assay is used to assess genomic instability through the measurement of fluorescently labelled antibodies to specific membrane proteins by flow-cytometric methodology.

differences in any outcome measure when results were compared between the low- and the high-uranium groups. However, modelling suggests a possible threshold effect for mutant frequencies occurring in the highest uranium exposed cohort members [M24]. This study demonstrates a relatively weak genotoxic effect of the DU exposure. In the second study [B2], the results indicate that ongoing systemic exposure to DU occurring in Gulf War I veterans with DU embedded fragments does not induce significant increases in micronuclei in peripheral blood lymphocytes compared to micronuclei frequencies in veterans with normal uranium body burdens.

219. Some studies investigated the possible effects of uranium exposure on chromosomal damage in workers and reported an increase in chromosomal aberrations in miners [P25, Z3, Z4] whereas others suggested no significant effects [B49, K21, L42, M33, M70, W25]. Martin et al. performed a study for workers from fuel production and fuel enrichment plants to analyse asymmetrical chromosome aberrations and sister chromatid exchanges [M13]. Both worker groups had higher levels of chromosome aberrations than the studied controls. This effect appeared not to be linked to external radiation. Smoking increased the frequency of dicentrics but not the sister chromatid exchanges in the workers exposed to soluble uranium, suggesting some interaction between the two clastogens.

220. In conclusion, some experimental studies performed on animals or on culture cells at high doses of uranium demonstrate an increase in the frequency of chromosomal aberrations (fragments, chromatid exchanges, reciprocal translocations). Human data are inconclusive but consistent with effects at higher levels of exposure.

## 7. Tumorigenic potential

221. Information about the carcinogenesis processes induced by uranium in experimental models and humans was provided by the WHO [I5]. Publications on experimental models are detailed below.

222. Chronic inhalation of natural uranium ore dust alone created a risk of primary malignant and non-malignant lung tumour formation in rats [M49]. The risk of the induction of malignant tumours was not directly proportional to dose but was directly proportional to dose rate. A study performed on mice reported an increase in osteosarcoma and acute myeloid leukaemia with <sup>239</sup>Pu and <sup>241</sup>Am but no significant difference between results for <sup>233</sup>U exposed animals and controls [E4]. The authors considered that the observed differences between the radionuclides were due to differences in irradiation of peripheral and central regions of the bone marrow, with lowest doses from <sup>233</sup>U. No renal and liver carcinomas were noted [E4].

223. A study by Hahn et al. conducted in vivo showed that intramuscular DU fragments induced soft tissue sarcomas (fibrous histiocytoma, fibrosarcoma and osteosarcoma) at the site of implantation [H3]. However, no direct dose-dependent relationship could be drawn due to the presence of varying corrosion products. Intravenous injection of murine haematopoietic cells into depleted-uranium-implanted mice was followed by the development of leukaemia in 76% of mice implanted with DU pellets in contrast to 12% of control mice [M44].

224. Miller et al. reported the ability of DU-uranyl chloride (10–250 µM) to transform immortalized human osteoblastic cells to the tumorigenic phenotype [M39]. The changes in phenotype are characterized by anchorage-independent growth, tumour formation in nude mice, expression of high levels of the k-ras oncogene, reduced production of the Rb tumour-suppressor protein, and elevated levels of sister chromatid exchanges per cell.

225. Some sparse studies have been performed on DU clean-up workers and on populations from depleted-uranium-contaminated regions [K20, M35, M36]. In clean-up workers, the total number of DNA alterations was higher immediately after decontamination than before decontamination, but tumours did not develop in the group of DU clean-up workers during the investigation period of four years [M36]. This point is not surprising, since four years would be a short latency period for the development of any tumour. In summary, some publications reported tumorigenic effects of uranium in animals (mice or rats) or tumorigenic potential in *in vitro* models.

## I. Relative biological effectiveness

226. Relative biological effectiveness is an empirical value that measures the capacity of a specific type of ionizing radiation to produce a biological effect in a particular biological system (for instance surviving fraction of irradiated cells). It is the ratio of biological effectiveness of one type of ionizing radiation relative to a reference radiation (gamma- or X-rays), given the same amount of absorbed energy. Thus, in the case of uranium isotopes, these values refer exclusively to radiobiological effects of alpha particles compared to the reference radiation. The chemical toxicity of uranium may influence observed RBE values. RBE values are used in experimental radiobiology and are also used by ICRP to derive radiation weighting factors for the calculation of effective dose, which allows the summation of radiation doses for all radiation types for the control of exposure. The value of the weighting factor used by ICRP for alpha particles is 20 compared with a value of 1 for all low-LET radiation [I15]. While there are no direct determinations of alpha particle RBE for uranium isotopes, and such studies would require the use of high specific activity isotopes such as  $^{233}\text{U}$  to avoid chemical effects, there is no reason to consider that alpha particles from uranium will have different relative effectiveness from alpha particles of similar energy emitted by other radionuclides (e.g.  $^{222}\text{Rn}$  and  $^{239}\text{Pu}$  [M12]).

## J. Lethal effects

227. The lesion that can cause animal death after acute contamination is tubular nephritis, which, as described above, results from the metallotoxic properties of uranium at high doses. Following intravenous injection of a soluble form of uranium, the lethal dose ( $\text{LD}_{50}$ ) over a period of three weeks after injection was measured as 0.1 mg/kg for rabbits and 20 mg/kg for mice [B20]. In rats, death occurred from 3 to 7 days for doses  $\geq 8$  mg/kg [F17]. Following oral ingestion of uranium acetate, the  $\text{LD}_{50}$  after two weeks was more than 100 mg/kg in rats and mice [D17].

228. One publication reported the deliberate ingestion of uranium (15 g of uranium acetate) [P9]. This ingestion resulted in an acute renal failure, with persistent renal impairment six months after the initial exposure. However, no death was reported despite the high uranium level ingested. This suggested that several grams of uranium for ingestion intakes are necessary for inducing death in humans [K5].

229. As indicated in the recent review of Pernot et al. [P14], the definition and classification of the different types of biomarkers have varied slightly, depending on the biomedical field considered. A biomarker has been defined as “any measurement reflecting an interaction between a biological system and an environmental agent, which may be chemical, physical or biological”. No real bioindicator is specific for uranium exposure. Concerning uranium exposure, the analysis of uranium content (total

concentration or radiological activity in  $^{238}\text{U}$ ,  $^{234}\text{U}$  and  $^{235}\text{U}$ ) in urine [C18, L21, S37] may provide information on uranium exposure. More indications are given in the uranium measurements section.

230. Since the kidneys are sensitive to damage by uranium, renal molecules were studied to describe potential health consequences [G27, G28]. However, standard potential bioindicators have not yet proven to be sufficiently specific and reproducible. The development and validation of bioindicators that link uranium exposure to renal damage would be valuable [G27].

231. Currently, urinary levels of albumin, glucose,  $\beta$ 2-microglobulin and N-acetyl- $\beta$ -D-glucosaminidase activity are used to evaluate possible renal effects of uranium in humans [K26, K28] or in animals [G27]. The use of osteopontin as a potential bioindicator of uranium effects was recently investigated in a combined experiment and human study [P30]. A decreased osteopontin level in urine was found when the concentration of uranium in urine, after acute exposure, exceeded 30  $\mu\text{g/L}$ . Such a decrease may suggest renal damage induced by uranium exposure. However, no clear relationship between exposure level, duration of exposure and observed renal effect can be drawn from the available studies on humans. One experimental study performed on rats at 40 mg/L of uranium in drinking water failed to demonstrate variations in renal osteopontin mRNA level in the kidneys [R27].

232. Zamora et al. [Z6] studied the effects of chronic ingestion of uranium via drinking water on human populations. They found statistically significant subtle changes in two of the biological indicators measured, namely ratios of glucose and LDH to creatinine excreted (table 13) that did not translate to any observed health effects. In addition, LDH excretion decreased with higher exposure. The excretion of  $\beta$ -2 microglobulin increased but the increase was not statistically significant.

233. Some biochemical parameters were measured in the urine of Gulf War veterans [M20, M22, M23, M24, M25, S32]. Table 14 summarizes some of the results obtained. None of the levels measured were statistically significantly different from control values. Glucose concentrations were lower for the high-exposed veterans whereas the concentrations of  $\beta$ -2 microglobulin and retinol binding protein were higher. The results of the study indicated that there were a few subtle trends in changes of biochemical parameter levels of exposure.

234. The use of omic techniques (genomics, proteomics and metabolomics) to screen unknown biological or toxicological effects is expanding to develop new bioindicators. Omic methodology has recently been used to screen mRNA, proteins or metabolome involved in the response to uranium exposure in various cell lines or in animals [G21, M6, P27, P29, T4, T5]. A recent study has demonstrated the relevance of metabolomics in cases of uranium exposure [G21]. The aim of this study was to assess the biological changes in rats caused by ingestion of natural uranium in drinking water over 9 months and to identify potential biomarkers related to such contamination. LC-MS metabolomics identified urine as an appropriate biofluid for discriminating the experimental groups. Of the 1,376 features detected in urine, the most discriminant molecules were metabolites involved in tryptophan, nicotinate, and nicotinamide metabolic pathways, in particular N-methylnicotinamide. These results are in accordance with a previous study that showed the role of N-methylnicotinamide in rats with experimental renal failure induced by uranium [S12]. The study of Grison et al. thus establishes the validity of using metabolomics to address chronic low-dose uranium contamination [G21]. These studies show that while reliable biomarkers of tissue damage are not yet available, modern techniques have the potential to identify such molecules.

Table 13. Inter-subject variability in bioindicator data (adapted from [Z6])

<i>Urinary parameter</i>	<i>Low exposure<sup>a</sup></i> ( $<1 \mu\text{g U/L}$ ( $n=20$ ))	<i>High exposure<sup>a</sup></i> ( $2\text{--}781 \mu\text{g/L}$ ( $n=30$ ))
Mass of glucose excreted (mg/d)	55.9 (20.2–111)	82.4 (32.7–427)
Mass of LDH per unit mass of creatinine excreted (U/g)	25 (7.6–66)	17 (0–410)
Mass of $\beta$ -2 microglobulin per unit mass of creatinine excreted ( $\mu\text{g/g}$ )	43 (11–270)	56 (15–340)

<sup>a</sup> Median value with range provided in brackets. The group ‘Low exposure’ is considered as the control group.

Table 14. Bioindicator data for Gulf War veterans (adapted from [M23])

<i>Urinary parameter</i>	<i>Normal range</i>	<i>Low exposure<sup>a</sup></i> ( $<0.1 \mu\text{g uranium per gram of creatinine}$ ( $n=25$ ))	<i>High exposure<sup>a</sup></i> ( $\geq 0.1 \mu\text{g uranium per gram of creatinine}$ ( $n=10$ ))
Glucose g/day	0.0–0.5	6.3 $\pm$ 4.38	0.12 $\pm$ 0.01
$\beta$ -2 microglobulin $\mu\text{g/g}$ creatinine	0–160	59.08 $\pm$ 7.48	81.72 $\pm$ 13.28
Urine retinol binding protein $\mu\text{g/g}$ creatinine	$<610$	31.00 $\pm$ 4.73	48.11 $\pm$ 9.73

<sup>a</sup> mean  $\pm$  standard error.

## VIII. EPIDEMIOLOGICAL STUDIES

235. Several population groups have been considered for epidemiological studies on the health effects of uranium due to occupational (uranium mines, milling and processing plants, facilities involved in the nuclear fuel cycle) or to environmental exposure (elevated uranium levels in drinking water, vicinity of uranium processing facilities or areas affected by depleted-uranium-munition use). Clear and comparative epidemiological information is limited. Nonetheless, in appendix A, tables A1–A4 summarize the principal studies and characterize their value in assessing uranium risks for occupational exposure, and tables A5 to A7 for environmental exposure.

### A. Studies of occupational exposure

236. The preparation of the fuel used in nuclear power plants relies on a complex cycle, including the steps of mining, crushing of the ore and preparation of Yellowcake (uranium mills and processing plants), conversion of uranium oxide to  $\text{UF}_6$ , enrichment, and fuel manufacturing. Other activities include research and reprocessing of the nuclear fuel. These activities involve different types of jobs and different patterns of uranium exposure. Also, historical methods of individual exposure monitoring vary (measurement of ambient exposure, bioassay of excreted uranium, personal film dosimeters, in vivo measurements).



237. Studies of workers involved in the nuclear fuel cycle present a good potential to investigate cancer and other health effects of internal uranium exposure on the basis of long-term follow-ups, insofar as they have individual estimates of exposure levels. These studies have been identified as among the most pertinent ones to quantify a potential exposure-risk relationship [L16].

## 1. Uranium miners

238. Miners are exposed to internal contamination due to inhalation of long-lived radionuclides (LLR) from uranium ore dust, but also to external gamma radiation and radon and its progeny. The main source of radiological exposure of uranium miners is radon and its decay products. Many epidemiological studies of uranium miners have been performed that demonstrated an association of accumulated exposure to radon and its decay products with lung cancer risk [I16, L17, N1, U9, W17].

239. A concerted European effort (Alpha risk project) [T10] has furthered the assessment of health risks associated with uranium exposure based on the Czech, French CEA-COGEMA and German Wismut cohorts. Individual exposure to uranium was estimated from measurement of ambient concentration (in Bq/m<sup>3</sup>). The assessment of uranium contamination in miners was based on the reconstruction of individual accumulated ore dust exposure over time. The development of dedicated dosimetric software enabled the estimation of cumulative organ doses due to radon and its progeny, LLR arising from uranium ore dust, and external gamma ray exposure [M10, M11]. This approach allowed the estimation of the contribution of uranium exposure to the total organ dose, and the initiative has resulted in a number of cohort and nested case-control studies of uranium exposure and mortality by cancers, leukaemia or cardiovascular diseases [D23, D31, K15, K17, M50, M51, M52, R4, R5, T13, V2]. A difficulty with the uranium miner studies is that the lung doses from short-lived radon decay products are much larger than and often correlated with the LLR exposure from uranium, which hampers the assessment of exposure effects for lung cancer.

## 2. Uranium millers

240. The first steps after uranium extraction are crushing of the ore and preparation of the Yellowcake by uranium millers or as part of uranium processing. Like the miners, millers are subjected to inhalation of radon and radon decay products, external gamma radiation and inhalation of LLR from uranium ore dust. One potential constraint of uranium miller studies is that, despite uranium LLR exposure being a higher percentage of total radiation dose, uranium miller exposure is typically much lower than uranium miner total exposure. Individual exposure to uranium among millers has been estimated solely from measurement of ambient concentration (in Bq/m<sup>3</sup>).

241. Only a few cohort studies have specifically considered health risks among uranium millers [B36, K17, P21, Z1]. These studies reported mortality results, but only the German miller study estimated individual LLR exposure from uranium ore dust and potential health risk [K18]. They studied 4,054 millers who had never worked in underground or open pit mines and assessed mortality from various diseases in relation to their exposure to radon, external gamma ray, LLR and silica dust exposure [K18].

### 3. Nuclear fuel cycle workers

242. A variety of epidemiological studies enabled the estimation of health risks among workers involved in the fuel nuclear cycle: in the United States (Fernald; Rocketdyne; Oak Ridge TEC, Y-12 and K-25; Paducah; Linde; Mallinckrodt), in the United Kingdom (UKAEA and AWE composite cohorts, Sellafield), and in France (CEA; AREVA NC; Eurodif) [C5, Z9, Z10].

243. After milling, the nuclear fuel cycle entails different successive steps, including conversion, enrichment, fuel manufacturing, reprocessing and research. These steps involve diverse radiological and chemical exposure to different forms of uranium compounds. However, as these steps are not distinguished in most of the epidemiological studies, they are considered together in this section. Individual exposure to uranium has often been estimated solely from measurement of ambient concentrations. Uranium exposure is preferably estimated from bioassays of individuals' excreted uranium or by other personal measurement (in vivo counting). In most studies exposure estimates for workers could be based only on ambient measurements at job locations or even extrapolations for time and location with no available ambient measurements.

### 4. Results of occupational exposure studies

244. The exposure situations may influence cancer risk in occupational settings, especially for lung cancers. For miners, the main exposures are from radon (internal exposure), external gamma radiation, and exposure to uranium dust. Typically, workers in the nuclear fuel production are subjected to less radon exposure but additional potentially toxic chemical exposure. In addition, for lung cancer, confounding factors may occur due to variations in smoking habits, about which most studies contain little or no information. Exposure levels have been assessed differently in various studies depending on the occupational exposure setting and the historical exposure information available.

245. Characteristics and results of uranium miner, miller and processor studies are summarized in appendix A, tables A1–A4, with the studies in tables A3 and A4 having more quantitative analyses. The health outcomes are described below by organ systems. Since well-conducted nested case-control studies provide risk estimates that in principle are comparable to those from the full cohort, the results of both types of studies are provided together without distinction.

246. Studies that have identified uranium-exposed cohorts have varied in the amount of data they presented to adduce uranium health effects. Studies that contain a subset of uranium-exposed workers who are not actually identified as exposed provide essentially no information on uranium effects; most studies in appendix A, table A1 fall into this category. Others have identified uranium workers but have no individual exposure levels and therefore provide only standardized mortality ratios (SMRs) or other overall statistics which yield little valid information on uranium effects because they consider those with appreciable exposure and little or no exposure as a composite group. Also, SMRs are subject to “healthy worker bias”; such studies are shown mainly in appendix A, table A2. Analyses by duration of employment can also be subject to “healthy worker survivor bias” and therefore should be viewed circumspectly. Analyses that show SMRs or relative risks (RRs), including hazard ratios (HRs) and odds ratios (ORs) by cumulative dose groups are somewhat informative, but difficult to interpret since the common problem of small numbers within groups leads to inconsistencies in risk estimates across groups; trend analysis summaries are helpful but fail to provide quantitative overall risk estimates (appendix A, table A3). Studies that provide quantitative risk estimates per unit of exposure are presented in appendix A, table A4.

247. Studies that explicitly estimate individual uranium exposure and use those data to calculate quantitative dose-response associations with specific health end points are valuable for assessing risk. Typically, dosimetric estimates are made for detailed types of jobs at particular work locations for specific periods based on ambient monitoring data, and this job exposure matrix (JEM) is applied to individual work records. Better individual dosimetry is achieved when individual urinalyses of uranium excretion or other personalized measurements are available, supplemented by ambient monitoring. However, some quantitative studies had limited ability to distinguish effects from LLR exposure from uranium from those associated with external irradiation or radon decay products because those doses were much larger than the LLR doses to organs. That problem applies especially to lung cancer among miners, since radon decay products usually contribute much more lung dose than LLR, so that in miner studies the LLR lung dose was often only 1–2% as great as the radon decay product dose and the two doses are typically correlated. In that situation, estimates of LLR-associated risk may be inaccurate to an unknown degree.

248. The following overview of associations of LLR exposure from uranium with diseases thought to be induced by uranium will concentrate on the most informative studies that have presented quantitative dose-response data. The most recent reports of study cohorts are shown in preference to older reports to avoid redundancy of information, since the most recent data with longer follow-up and sometimes improved dose information provide better risk estimates.

249. The study results will be considered by organ systems. Essentially, all the informative studies of occupational populations exposed to uranium have been conducted since 1980, some with exposure dating back to the mid-1940s. These studies considered a large range of potential health effects. Among the most frequently considered ones are respiratory cancers (lung, laryngeal), urological cancers (kidney, bladder, prostate), digestive cancers (stomach, intestine, liver, pancreas), cancers of brain and central nervous system, lympho-haematopoietic malignancies (leukaemia, lymphoma, multiple myeloma). Non-cancer diseases have also been considered, especially respiratory, circulatory and renal system diseases. Further details about these studies are presented in appendix A, table A4.

### (a) *Lung cancer and other respiratory diseases*

250. *Lung cancer.* Studies with quantitative risk estimates for respiratory diseases from LLR exposure from uranium are presented in table 15. Ten reports were found that had dose-response estimates for lung cancer risk based on individualized estimates of uranium exposure. The study of CEA-COGEMA miners in France reported a positive risk coefficient for LLR exposure from uranium, though the radon and external-radiation co-exposure make the result difficult to interpret. Other miner studies have not characterized and analysed LLR exposure from uranium and lung cancer. The German study of uranium millers [K18] reported a dose-response analysis of LRR exposure from uranium and lung cancer risk. The association was non-significant and in the negative direction. Two other studies of uranium millers reported no significant elevation in lung cancer mortality [B36, P21].

251. The remaining eight reports of LLR dose-related lung cancer mortality were based on workers in nuclear processing industries. The nature of the workplaces and the types of measurements and procedures that generated the individual exposure estimates are given in appendix A, table A4, for the various studies. The large study of Fernald workers, with 269 lung cancer deaths, showed a positive, but non-significant, association and most other studies had negative or non-significant coefficients of risk. Additional uranium worker cohorts showed no significant elevation in overall lung cancer SMRs [C36, D33, D34, M26, M27]. However, the relatively small French study of the AREVA NC Pierrelatte plant showed significant positive dose responses [G31]. This is the only study that conducted separate analyses for exposure to uranium compounds that differ in solubility (Types: F, M and S). They found

the Type M and Type S exposure conferred lung cancer risk (table 15). In a further analysis [G32] that distinguished exposure to natural uranium from the reprocessed uranium which has a different isotope composition, they found that risks were especially dose related for reprocessed uranium of the Type M and Type S. This suggests that insoluble uranium particles with a longer residence time in the lung confer more risk than the more soluble particles with a shorter residence time. However, these interesting results were based less than 55 lung cancer deaths and require confirmation in larger studies.

Table 15. Dose-response studies of uranium exposure and risk of respiratory system diseases

<i>Study references</i>	<i>No. of deaths</i>	<i>Nature of uranium work</i>	<i>Unit of uranium (LLR) exposure</i>	<i>Risk estimate per unit LLR exposure<sup>a</sup></i>
<b>LUNG CANCER</b>				
France, CEA-COGEMA [R5] (Also [R4, V2])	94	Mining	kBqh/m <sup>3</sup>	ERR=0.32 (95% CI: 0.09, 0.73)
Germany, milling [K18]	159	Milling	100 kBqh/m <sup>3</sup>	ERR=-0.61 (95% CI: -1.42, 1.9)
France, AREVA NC [C6]	48	Processing	Years of Types F, M, and S uranium exposure	HR=1.01 (95% CI: 0.96, 1.01) [F] 1.07 (1.01, 1.13) [M] 1.07 (1.01, 1.14) [S]
France, AREVA NC [G32]	53	Processing	Years of exposure to Types F, M and S reprocessed uranium	HR=1.07 (95% CI: 0.96, 1.19) [F] 1.13 (1.03, 1.25) [M] 1.13 (1.01, 1.25) [S]
USA, TEC/Y-12/Mallinckrodt/Fernald [D35] <sup>b</sup>	787	Processing	0.5, 2.5, 5, 25, 50, ≥250 mGy LLR	OR=1.03, 0.57, 0.85, 0.82, 0.64, 2.05 (95% CI: 0.20, 21), respectively <sup>c</sup>
USA, Rocketdyne [B38]	94	Processing	100 mSv LLR	RR=1.01 (95% CI: 0.89, 1.16)
USA, Fernald [S19]	269	Processing	mGy LLR	ERR=0.022 (95% CI: -0.009, 0.06)
USA, Paducah gaseous diffusion [C17]	129	Processing	μg.y	RR=0.91 (95% CI: 0.5, 1.6) (21-50 μg.y) 0.95 (0.6, 1.6) (51-125 μg.y) 0.51 (0.3, 0.9) (>125 μg.y)
USA, Y-12 [R12]	111	Processing	10 mSv LLR	ERR=-0.77 (95% CI: -2.5, 1.0)
France, Gaseous diffusion [Z10]	100	Processing	Low, medium, high	Exposure to natural soluble uranium compounds (with 90% CI): Medium: RR=0.92 (CI: 0.54, 1.6) High: RR=0.74 (CI: 0.42, 1.3)  Enriched uranium (n=23): Medium RR=1.8 (CI: 0.64, 4.6) High RR=0.69 (CI: 0.21, 1.9)  Depleted uranium (n=23): Medium RR=1.2 (CI: 0.33, 3.7) High RR=1.5 (CI: 0.61, 3.9)
<b>EXTRATHORACIC RESPIRATORY CANCERS</b>				
Germany, Wismut [M51]	554	Miners	10 kBqh/m <sup>3</sup>	ERR=0.098 (95% CI: -0.11, 0.31) (Laryngeal cancer)
Germany, Wismut [K17]	234	Miners	100 kBqh/m <sup>3</sup>	ERR=-0.17 (95% CI: -2.50, 2.16) (All extra-thoracic airway cancers)

Study references	No. of deaths	Nature of uranium work	Unit of uranium (LLR) exposure	Risk estimate per unit LLR exposure <sup>a</sup>
NON-MALIGNANT RESPIRATORY DISEASE				
France, CEA-COGEMA [R5]	37	Miners	kBq/m <sup>3</sup>	ERR=-0.086 (95% CI: n.e.) <sup>d</sup>
USA, Y-12 [R12]	50	Processing	100 mSv	ERR=-0.085 (90% CI: -0.32, 0.15)
USA, Fernald [S19] <sup>e</sup>	102	Processing	100 µGy LLR	ERR=-0.0062 (95% CI: -0.007, 0.0006)

<sup>a</sup> Risk estimation metrics: ERR (excess relative risk) for which zero represents no excess or deficit; HR (hazard ratio) and RR (relative risk or rate ratio) are expressed as a multiple of the rate in the baseline (lowest/no exposure) group. (ERR = RR - 1).

<sup>b</sup> This study [D35] was partially repeated later on [R12, S19] but included two cohorts that were not reported elsewhere.

<sup>c</sup> The risk estimate of 2.05 for the ≥250 mGy group became 0.36 in an analysis with adjustment for smoking.

<sup>d</sup> Not estimable from the likelihood profile.

<sup>e</sup> Analysis of chronic obstructive pulmonary disease.

252. In summary, there is mixed evidence for the lung carcinogenicity of uranium. The inconsistency may relate to variations in the amount and types of exposure data available (e.g. extrapolated dose reconstruction, ambient monitoring, uranium urinalyses or other personalized exposure measures) or to variations in methods for calculating LLR doses from the raw data. The inconsistency can also relate to other radiation or chemical exposure that may not have been adequately accounted for in the LLR analyses, or to dose-dependent variations in smoking behaviours. On the other hand, since the studies have low statistical power to detect risks, given the relatively small numbers of lung cancers and fairly low levels of LLR exposure from uranium for most workers, it is notable that two cohorts with dose-response data showed a statistically significant association [C6, R5].

253. *Other respiratory cancers.* A study of all extrathoracic airway cancers, based on a well-defined cohort of the German uranium miners, showed a negative dose-response coefficient for LLR exposure from uranium [K17]. Another study of German uranium miners had LLR dose-response data for laryngeal cancer, which yielded a non-significantly positive risk coefficient [M51]. There was no association of LLR exposure from uranium and laryngeal cancer among French uranium miners [R5]. Other studies have reported overall excess laryngeal or upper airway cancers in worker populations potentially exposed to uranium [B18, B29, B33, D35, G31], but those are based on small numbers of cancers, without individual uranium exposure estimates, and with limited information on the risk factors of smoking and alcohol intake.

254. *Non-malignant respiratory disease (NMRD).* Four studies with dose-response analyses all reported negative dose-response coefficients for NMRD [B38, R5, R12, S19]. Pinkerton et al. [P21] reported an inverse relationship of NMRD with length of time working in uranium milling. SMRs in a number of other cohorts with uranium exposure were not significantly elevated [C20, C36, D33, D34, M26, M27, R14, Z10] so there is no evidence that NMRD is associated with uranium exposure.

## (b) Lymphatic and haematopoietic cancer

255. *Leukaemia.* Since leukaemia shows a large excess relative risk from radiation exposure, it is a strong a priori candidate to investigate regarding uranium exposure effects. Table 16 shows uranium dose-response related results for leukaemia. A nested case-control study of leukaemia mortality within the large collection of German Wismut miners [M50] found a positive but non-significant association of estimated LLR exposure with non-chronic lymphocytic leukaemia (non-CLL) risk. The positive risk coefficient was driven entirely by the highest dose group (≥20 kBq/m<sup>3</sup>, ERR=1.26, 90% CI: 0.7, 2.2,

n=14). A smaller miner study in Czechia found a statistically significant dose-response association of leukaemia mortality with total red bone marrow dose, of which the majority was from LLR exposure [T13]. Three smaller dose-response studies of leukaemia risk in the uranium processing industries did not support excess risk (table 16). In summary, there is limited dose-response evidence for an association of uranium exposure with subsequent leukaemia. Atkinson et al. [A29] reported a non-significant SMR (SMR=1.10; 95% CI: 0.89, 1.33; n=103) in nuclear workers, particularly among workers monitored for internal radiation exposure. Others likewise have reported non-significant overall SMRs in uranium worker cohorts [C36, D30, D33, D34, L44, M26, M27, P24, S5, Z2, Z10], but did not estimate worker uranium doses or conduct LLR dose-related analyses.

256. *Other lympho-haematopoietic malignancies.* Lymphoma is a biologically plausible outcome of inhalation exposure to uranium, since uranium deposited in the lung tends to migrate to the thoracic lymph nodes. However, there are few studies providing dose-dependent analyses of uranium exposure and lympho-haematopoietic malignancies other than leukaemia (table 16). The cohort of German uranium millers [K18] showed a non-significant negative risk coefficient for all lympho-haematopoietic malignancies. In the Rocketdyne cohort there was a non-significant positive dose-response [B38], though the specifics were not reported. A French study of gaseous diffusion plant workers reported a non-significant excess risk for all lympho-haematopoietic malignancies other than leukaemia among those with medium or high exposure to soluble uranium [Z10]. A study in the United States showed for uranium miners an elevated risk of lympho-haematopoietic malignancies (SMR=1.38, 95% CI: 1.03, 1.82) [S5]. Pinkerton et al [P21] showed a suggestive excess of lymphatic and haematopoietic malignancies, excluding leukaemia, (SMR=1.44, 95% CI: 0.83, 2.35, n=16) with no dose response.

257. A study of non-Hodgkin's lymphoma (NHL) at the Paducah gaseous diffusion plant [C17] produced high relative risks, but the fact that there was no dose response suggests that the high values are likely attributable to a deficit of NHL in the baseline comparison group rather than large excesses in the other dose groups. NHL mortality was non-significantly elevated for exposure to uranium in the Fernald cohort [S19]. The Czech uranium miner study [T13] indicated a non-significantly elevated SMR of 1.4 (95% CI: 0.9, 5.1, n=16) for NHL but did not provide a dose-response analysis. Other uranium worker cohorts reported null overall SMRs for lymphomas or all lympho-haematopoietic cancers [B38, C9, C36, D30, D33, D34, G31, L44, M27, P21, P24, S5, Z2].

258. In the study at the Oak Ridge K-25 gaseous diffusion plant by Yiin et al. [Y3] with a dose-response analysis of multiple myeloma and uranium exposure, a significant association was not found. A significant overall excess of multiple myeloma was found among United States miners (SMR=1.97, 95% CI: 1.05, 3.37, n=13), and an excess based on two cases (SMR=8.38; 90% CI: 1.44, 26.20) was reported among French CEA-COGEMA uranium processing workers [B9]. A non-significant excess of multiple myeloma was observed among Mallinckrodt uranium processing workers [D33] (SMR=1.30, 95% CI: 0.42, 3.0, n=5). The SMRs for multiple myeloma were not significantly elevated in other uranium worker groups [C17, Z2].

Table 16. Dose-response studies of uranium exposure and risk of lympho-haematopoietic malignancy mortality

Study references	No. of deaths	Nature of uranium work	Unit of uranium (LLR) exposure	Risk estimate per unit LLR exposure <sup>a</sup>
<b>LEUKAEMIA</b>				
Germany, Wismut [M50]	218 (non-CLL) <sup>b</sup>	Mining	100 kBq/m <sup>3</sup>	ERR=0.76 (90% CI: -1.26, 2.78)
Czechia [T13]	30	Mining	Sv <sup>c</sup>	ERR=2.5 (90% CI: 0.3, 9.3)
USA, Paducah [C17]	21 (all types)	Processing	#1 (0–20 µg.y) #2 (21–50 µg.y) #3 (51–125 µg.y) #4 (>125 µg.y)	Baseline #2: RR=0.73 (95% CI: 0.2, 3.0) #3: RR=0.49 (CI: 0.2, 2.3) #4: RR=0.77 (CI: 0.2, 2.5)
USA, Rocketdyne [B38]	10 (non-CLL)	Processing	100 mSv LLR	RR=1.06 (95% CI: 0.50, 2.23)
USA, Fernald [S19]	28 (non-CLL)	Processing	100 µGy LLR	HR=0.18 (95% CI: 0.012, 0.80)
<b>OTHER LYMPHO-HAEMATOPOIETIC MALIGNANCIES</b>				
Germany [K18]	23 (all lympho-haematopoietic)	Millers	100 kBq/m <sup>3</sup>	ERR= -0.65 (95% CI: -2.78, 1.47)
Zhivin, Gaseous diffusion [Z10]	28 (all lympho-haematopoietic)	Processing	Medium and high exposure	Natural soluble uranium compounds (with 90% CI): Medium RR=1.4 (CI: 0.52, 3.9) High RR=1.08 (CI: 0.37, 3.3)
USA, Paducah [C17]	26 (non-Hodgkin's lymphoma)	Processing	#1 (0–20 µg.y) #2 (21–50 µg.y) #3 (51–125 µg.y) #4 (>125 µg.y)	Baseline #2: RR=9.95 (95% CI: 1.2, 81) #3: RR=8.85 (CI: 1.1, 71) #4: RR=5.74 (CI: 0.7, 45)
USA, Fernald [S19]	12 (non-Hodgkin's lymphoma)	Processing	100 µGy	HR=1.2 (95% CI: 0.88, 1.5)
USA, K-25 [Y3]	98 (multiple myeloma)	Processing	10 µSv	OR, 1.04 (95% CI: 1.00, 1.09)

<sup>a</sup> Risk estimation metrics: ERR (excess relative risk) for which zero represents no excess or deficit; HR (hazard ratio) and RR (relative risk or rate ratio) are expressed as a multiple of the rate in the baseline (lowest/no exposure) group. (ERR = RR – 1).

<sup>b</sup> Non-CLL, all leukaemias except chronic lymphocytic leukaemia.

<sup>c</sup> Analysis was for total red bone marrow dose, of which 52–64% was estimated to be due to LLR from uranium dust inhalation.

### (c) Digestive system cancer

259. *Stomach cancer.* Only a few studies have conducted dose-dependent analyses of uranium exposure and digestive system cancers (table 17). Studies of German uranium millers [K18], the Fernald uranium processors [S19], and Rocketdyne workers with internal exposure monitoring [B38] all showed weakly positive but non-significant dose-response risk estimates for stomach cancer. The risk of mortality from stomach cancer was increased with the alpha absorbed stomach dose among German uranium miners (ERR per Gy=37.3; 95% CI: 3.4, 71.1, n=592), but the contribution of LLR to

the absorbed stomach dose was less than 1% [K15]. Other uranium worker cohorts reported null overall SMRs for stomach cancer [B38, C9, C17, D34, L44, M26, R5, S5, Z1, Z10].

260. *Intestinal cancer.* The study of German uranium millers showed non-significant ERR coefficients for both colon and rectal cancers [K18], and both the French uranium miners study [R5] and the Rocketdyne study [B38] reported non-significant LRR dose coefficients for colorectal cancers. On the other hand, a dose-response analysis of combined small intestine and colon (but not rectum) cancer at the United States Fernald uranium processing plant yielded a statistically significant excess risk [S19]. Since this result was based on relatively small numbers, it is in need of confirmation by larger studies. Other uranium worker cohorts reported null overall SMRs for colon or colorectal cancers [C9, D33, D34, G31, L44, M26, P21, Z1, Z10] but did not conduct LLR dose-related analyses.

261. *Pancreatic cancer.* The United States Paducah [C17] and Fernald [S19] studies provided dose-response analyses of pancreatic cancer after LLR exposure (table 17). Neither study provided an indication of an association with uranium exposure, nor did the studies of French uranium miners [R5] or Rocketdyne workers [B38]. However, the studies had relatively small numbers of pancreatic cancers and thus limited statistical power. Other reports have indicated non-significant SMRs for pancreatic cancer in uranium processing workers [C36, D33, D35, L44, M26, Z1, Z10] but did not estimate worker uranium doses or conduct LLR dose-related analyses.

Table 17. Dose-response studies of uranium exposure and risk of digestive system disease mortality

Study references	No. of deaths	Nature of uranium work	Unit of uranium (LLR) exposure	Risk estimate per unit LLR exposure <sup>a</sup>
STOMACH CANCER				
Germany, [K18]	49	Milling	100 kBqh/m <sup>3</sup>	ERR=1.5 (95% CI: -2.9, 5.9) <sup>b</sup>
USA, Fernald [S19]	29	Processing	100 µGy	ERR=0.041 (95% CI: -0.20, 5.6)
INTESTINAL CANCER				
Germany, [K18]	22 (colon)	Milling	100 kBqh/m <sup>3</sup>	ERR=-0.07 (95% CI: -3.3, 3.2)
Germany, [K18]	26 (rectum)	Milling	100 kBqh/m <sup>3</sup>	ERR=0.56 (95% CI: -3.1, 4.2)
USA, Fernald [S19]	48 (colon & small intestine)	Processing	100 µGy	ERR=1.5 (95% CI: 0.12, 4.1)
PANCREATIC CANCER				
USA, Paducah [C17]	30	Processing	#1 (0-20 µg.y) #2 (21-50 µg.y) #3 (51-125 µg.y) #4 (>125 µg.y)	Baseline #2: RR=1.42 (95% CI: 0.4, 4.7) #3: RR=0.49 (95% CI: 0.1, 1.9) #4: RR=0.97 (95% CI: 0.3, 3.0)
USA, Fernald [S19]	41	Processing	100 µGy	HR= 0.61 (95% CI: 0.015, 3.5)

<sup>a</sup> Risk estimation metrics: ERR (excess relative risk) for which zero represents no excess or deficit; HR (hazard ratio), RR (relative risk or rate ratio) and OR (odds ratio for case-control studies) are expressed as a multiple of the rate in the baseline (lowest/no exposure) group. (ERR = RR - 1).

<sup>b</sup> Estimate is adjusted for radon exposure levels.

262. *Liver cancer.* Dufey et al. [D31] observed a non-significant increase in liver cancer mortality risk associated with high-LET absorbed liver dose among German uranium miners (ERR per Gy=48.3; 95% CI: -32.0, 128.6 (n=159) after adjustment for low-LET dose). However, the contribution of LLR to the absorbed liver dose was less than 2%, so the association is not informative regarding uranium risk. Among French uranium miners there was also a non-significant association of LLR exposure and liver



cancer risk [R5]. Other uranium worker cohorts reported non-significant SMRs for liver cancer [B38, C9, M26, M27, P24, R5, Z10] but had no uranium dose-response analyses.

263. In summary, there is no persuasive evidence of an association between uranium exposure and digestive cancers. The effect, if any, is likely small. However, the relatively small numbers of digestive cancer cases and consequent limited statistical power to detect effects make any conclusion uncertain.

#### (d) *Kidney and other urological cancers*

264. *Kidney cancer.* The toxicological data suggest that uranium exposure may be related to urological cancers, especially to the kidney because of the potential for both adverse radiological and metal effects upon that organ. The available epidemiological studies with dose-response results are shown in table 18. Dose-response analyses of kidney cancer in relation to LLR exposure have been conducted for the cohorts of miners in France and Germany [D23]. Neither cohort showed a significant association with kidney cancer even though the large German miner cohort had a substantial number of renal cancers. In the French CEA-COGEMA cohort, the overall SMR was elevated for kidney cancer (SMR=2.0, 95% CI: 1.2, 3.1, n=20), but LLR analyses were not reported [V1].

Table 18. Dose-response studies of uranium exposure and risk of urological system disease mortality

<i>Study references</i>	<i>No. of deaths</i>	<i>Nature of uranium work</i>	<i>Unit of uranium (LLR) exposure</i>	<i>Risk estimate per unit LLR exposure<sup>a</sup></i>
KIDNEY CANCER				
France, CEA-COGEMA [D23]	11	Mining	kBqh/m <sup>3</sup>	HR=0.89 (95% CI: 0.55, 1.42)
Germany, Wismut [D23]	174	Mining	kBqh/m <sup>3</sup>	HR=1.009 (95% CI: 0.991, 1.027)
Germany [K18]	11	Milling	100 kBqh/m <sup>3</sup>	ERR=7.36 (95% CI: -11, 26)
USA, Fernald [S19]	15	Processing	100 µGy	ERR=0.039 (95% CI: -0.021, 0.55)
OTHER UROLOGICAL DISEASES				
Germany [K18]	30 (Prostate cancer)	Milling	100 kBqh/m <sup>3</sup>	ERR=0.21 (95% CI: -2.8, 2.4)
USA, Fernald [S19]	19 (chronic kidney disease)	Processing	100 µGy	HR=0.98 (95% CI: 0.78, 1.1)

<sup>a</sup> Risk estimation metrics: ERR (excess relative risk) for which zero represents no excess or deficit; HR (hazard ratio) and RR (relative risk or rate ratio) are expressed as a multiple of the rate in the baseline (lowest/no exposure) group. (ERR = RR - 1).

265. The study of German uranium millers [K18] had a large risk coefficient for kidney cancer but the association was non-significant because the number of cases was small (n=11) and consequently the confidence interval of the estimate was very wide. The dose-response coefficients for the Fernald uranium processing workers [S19], the Rocketdyne workers [B38] and the French uranium miners [R5] were all non-significant. Overall SMRs for kidney cancer were found to be increased in two uranium-processing facilities: Y-12 [C20, L44] and Capenhurst [M26]. But at Capenhurst, the increase was limited to unexposed workers. The UK Nuclear research workers also experienced elevated mortality from kidney cancer [B18, C8]. However, none of these studies included an investigation of the relation with internal exposure to uranium. Other uranium worker studies did not report significantly elevated overall SMRs for kidney cancer [C9, C17, L44, S5, Z10] but had no uranium dose-response analyses.

266. *Bladder cancer.* French uranium miner studies reported a non-significant LLR dose-response association with bladder cancer [R5]. An increase in mortality (an elevated overall SMR) from bladder cancer was reported among Fernald workers [D35]. It was potentially associated with a high exposure to the cutting fluids used during uranium metal production but not with internal exposure to uranium compounds [R14]. In a more recent study of the Fernald workers [S19], elevated mortality was observed only among salaried female workers; for cancer of the bladder and other urinary organs, the SMR was 5.13 (95% CI: 1.06, 15.0; n=3). However, the small number of cases, no increase in bladder cancer mortality among males (n=21) or hourly paid female workers (n=0), and no dose-response information argue against a meaningful excess [S19]. Other reports have indicated non-significant risks (usually SMRs) for bladder cancer in uranium processing workers [B38, Z1, Z10], but did not estimate worker uranium doses or conduct LLR dose-related analyses.

267. *Prostate cancer.* The recent study of German uranium millers analysed uranium dose and prostate cancer risk and found no evidence of an association [K18], albeit the number of prostate cancer deaths was small (table 18). The study of United States Rocketdyne workers reported a non-significant dose-response trend in the negative direction for prostate cancer (n=63), but did not provide a risk coefficient [B38]. The LLR dose-response trend among French uranium miners was likewise non-significant [R5].

268. Radiation-exposed worker cohorts with excess prostate cancer have been investigated for internal radionuclide exposure in the UK Atomic Energy Authority cohorts [A28, B18, R22] but with only a limited examination of uranium exposure. Rooney et al. [R22] conducted a nested case-control examination of the relation between prostate cancer and occupational exposure in those cohorts, including 136 prostate cancer cases and 404 controls and examination of 29 radionuclides. Three cases and twelve controls had an indication of potential uranium exposure, and zero cases and six controls had documented uranium exposure (RR=0, 95% CI: 0, 2.55), so no effect on prostate cancer mortality was observed. Other studies have reported non-significant overall SMRs for prostate cancer among uranium workers [D33, L44, M26, Z1, Z10] but had no uranium dose-response analyses.

269. In summary, except for the German Wismut cohort, the number of kidney cancers was very small, thus constraining the ability to detect small-to-moderate effects. Since the studies of kidney cancer and chronic kidney disease are uniformly negative, the risk of uranium exposure for kidney cancer is weak or absent. The data do not generally support an increase in bladder cancer associated with uranium exposure; in fact, the only dose-response report regarding bladder cancer risk had a negative coefficient [B38]. The two studies that have evaluated dose-response data for prostate cancer did not show a significant association.

#### (e) *Brain and central nervous system cancers*

270. Experimental evidence indicates that uranium compounds, particularly more soluble ones, cross the blood-brain barrier, thereby potentially putting the brain at risk. There have been only a small number of studies with dose-response analyses of brain and central nervous system (brain/CNS) tumours (table 19). An analysis of brain/CNS tumours by LLR dose groups was conducted among Paducah gaseous diffusion uranium enrichment workers [C17], but no trend by dose was seen. A study of French uranium miners reported a non-significantly positive brain/CNS tumour dose-response risk for LLR exposure, accompanied by an overall excess (SMR=1.71, 95% CI: 1.00, 2.74) [R5]. Similarly, three United States studies of uranium processing workers did not find a dose-related excess of brain/CNS tumours [B38, C17, C20].

271. Carpenter et al. [C7] investigated the possible association between brain/CNS cancers and exposure to external and internal radiation among Oak Ridge Y-12 workers. The internal dose to the

lung, calculated as in the study by Checkoway et al. [C20], was used as a surrogate for the internal dose to the brain for the 47 cases and 120 matched controls. Odds ratios (ORs) were non-significantly elevated for categories of cumulative lung dose:  $\geq 150$  to 290 mSv (OR=2.8; 95% CI: 0.7, 11.9; n=5);  $\geq 300$  to 450 mSv (OR=2.7; 95% CI: 0.8, 9.3; n=5); and among workers with mean annual lung dose  $> 150$  mSv (OR=1.7; 95% CI: 0.7, 4.2; n=16). No dose–response trend was observed after adjustment for possible confounding factors (26 different chemicals, socio-economic status, duration of employment), using either a 5- or 10-year dose lag. Other studies of uranium worker cohorts indicated no significant overall excess of brain/CNS tumour deaths [C9, D33, L44, M26, M27, P24, R14, Z10] but did not estimate worker uranium doses or conduct LLR dose-related analyses.

272. A limiting factor in all of these studies was the very small numbers of tumours, so only quite a large excess risk would be detectable. Clearly more data are needed to make a better judgment about brain/CNS tumour risk from uranium exposure.

**Table 19. Dose-response studies of uranium exposure and risk of brain and central nervous system (CNS) tumour mortality**

<i>Study references</i>	<i>No. of deaths</i>	<i>Nature of uranium work</i>	<i>Unit of uranium (LLR) exposure</i>	<i>Risk estimate per unit LLR exposure<sup>a</sup></i>
<b>BRAIN/CNS TUMOURS</b>				
France, CEA-COGEMA [R5] [Also [V2]]	17	Mining	kBq/m <sup>3</sup>	ERR=0.28 (95% CI: n.e. <0, 1.87) <sup>b</sup>
USA, Paducah [C17]	14	Processing	#1 (0–20 µg.y) #2 (21–50 µg.y) #3 (51–125 µg.y) #4 (>125 µg.y)	Baseline #2: RR=0.66 (95% CI: 0.1, 4.2) #3: RR=1.07 (95% CI: 0.2, 4.8) #4: RR=0.45 (95% CI: 0.1, 2.2)
USA, Y-12 [C20]	14	Processing	#1 (0–9 mSv) #2 (10–49 mSv) #3 ( $\geq 50$ mSv LLR)	Baseline #2: RR=1.10 (95% CI: 0.2, 6.5) #3: RR=0.45 (95% CI: 0.1, 3.2)

<sup>a</sup> Risk estimation metrics: ERR (excess relative risk) for which zero represents no excess or deficit; HR (hazard ratio) and RR (relative risk or rate ratio) are expressed as a multiple of the rate in the baseline (lowest/no exposure) group. (ERR = RR – 1).

<sup>b</sup> n.e. = not estimable from the likelihood profile.

## (f) *Circulatory diseases*

273. Suggestive findings from external radiation studies over the past 15–20 years have prompted examinations of circulatory disease risks as a potential radiation effect of internal radionuclides. The available studies of uranium exposure have evaluated the risk for all circulatory system diseases (CSD) and major subcategories of CSD, namely ischaemic heart diseases (IHD) and cerebrovascular diseases (CeVD) (table 20).

274. *Circulatory system diseases.* The German Wismut miner cohort is the largest to study uranium associated CSD risk. They reported a negative CSD risk coefficient for internal LLR exposure on the basis of 5,417 CSD deaths [K14]. Two reports of CSD in the French CEA-COGEMA miner cohort are of interest (table 20). A report of the entire cohort indicated a non-significantly positive risk coefficient [R5], while another report of the subset of the cohort for whom information on radon, external radiation exposure, and medical risk factors for CSD also was available showed a nearly significant risk of CSD from LLR exposure after accounting for the other factors [D24].

275. A report of the French AREVA NC uranium processing cohort found that exposure to Type M and Type S (less soluble) reprocessed uranium conferred statistically significant risk of CSD, as did Type S natural uranium exposure [G33], but Type F exposure did not. The study found statistically significant associations of CSD with the number of years exposed to Type S exposure to both reprocessed and natural uranium, and a near-significant association for Type M reprocessed uranium (table 20) [G33]. Less quantitative but supportive findings were that CSD mortality was increased overall among workers exposed to slowly soluble reprocessed (HR=2.13; 95% CI: 0.96, 4.70) and natural uranium (HR=1.73; 95% CI: 1.11, 2.69). In the subgroup of smokers, the risk estimates were higher but with larger CIs (HR=1.91; 95% CI: 0.92, 3.98 for natural uranium and HR=4.78; 95% CI: 1.38, 16.50 for reprocessed uranium). The AREVA NC findings suggested that types of uranium with a long residence time in tissues may confer risk of CSD.

276. McGeoghegan et al. [M29] reported an association between mortality from CSD and radiation exposure in males performing industrial work in the British Nuclear Fuels Limited cohort (BNFL). This cohort consisted partially of uranium workers (37% of the cohort were workers employed at the Springfields uranium processing plant and 6.7% at the Capenhurst uranium enrichment plant). Their analysis of internal exposure to any radionuclide gave a dose-response ERR per Gy of 0.76 (90% CI: 0.37, 1.23; n=2,275), but a dose-response analysis was not available specifically for uranium exposure.

277. *Ischaemic heart diseases.* The large German Wismut study of uranium miners found a negative risk coefficient for LLR exposure and the end point of all heart disease (table 20) [K14]. The other studies evaluated IHD as a cardiovascular end point. Studies of French uranium miners (CEA-COGEMA) reported negative risk coefficients for IHD for the entire cohort [R5] and for the subset where they could account for radon, external radiation, and medical heart disease risk factors [D24]. The German uranium miller study also reported a non-significantly negative risk coefficient for LLR dose [K18]. McGeoghegan et al. [M29] reported an association between mortality from IHD and radiation exposure in males performing industrial work at BNFL. Their analysis of internal exposure to any radionuclide gave a dose-response ERR per Gy of 0.52 (90% CI: 0.09, 1.06; n=1,494), but uranium exposure was not analysed.

278. *Cerebrovascular diseases.* The same set of studies also provided risk estimates for CeVD (table 20). The large German Wismut study of uranium miners found a negative risk coefficient for LLR exposure and CeVD [K14]. Studies of French uranium miners (CEA-COGEMA) reported non-significant positive risk coefficients for CeVD for the entire cohort [R5] and for the subset with adjustment for radon, external radiation, and medical heart disease risk factors [D24]. The German uranium miller study reported a non-significantly negative risk coefficient for LLR dose [K18]. In the study of French AREVA NC uranium processing workers, there was a statistically significant risk for Type S exposure to reprocessed uranium and a near-significant risk for Type M reprocessed uranium [G33], but little indication of risk from natural uranium exposure. Further, McGeoghegan et al. [M29] also reported an association between mortality from CeVD and radiation exposure in males performing industrial work in the BNFL cohort. Their analysis of internal exposure to any radionuclide gave a dose-response ERR per Gy of 1.47 (90% CI: 0.49, 3.00; n=456).

Table 20. Dose-response studies of uranium exposure and risk of circulatory system disease mortality

<i>Study references</i>	<i>No. of deaths</i>	<i>Nature of uranium work</i>	<i>Unit of uranium (LLR) exposure</i>	<i>Risk estimate per unit LLR exposure<sup>a</sup></i>
<b>ALL CIRCULATORY SYSTEM DISEASES</b>				
Germany, Wismut [K14]	5 417	Mining	100 kBq/m <sup>3</sup>	ERR=-0.2 (95% CI: -0.5, 0.06)
France, CEA-COGEMA [R5]	185	Mining	kBq/m <sup>3</sup>	ERR=0.016 (95% CI: -0.06, 0.13)
France, CEA-COGEMA [D24]	76	Mining	kBq/m <sup>3</sup>	HR=1.13 (95% CI: 0.97, 1.31)
France, AREVA NC [G33]	111	Processing	Reprocessed uranium, absorption Types M, S	HR (95% CI) Cumulative exposure duration (per year): 1.09 (1.02, 1.18) [M] 1.11 (1.03, 1.20) [S] 1.04 (1.00, 1.07) for natural uranium [S]  High cumulative exposure: 3.40 (1.47, 7.85) [M] 8.79 (1.21, 28) [S] 2.84 (1.38, 5.85) for natural uranium [S]  Cumulative exposure score: 1.14 (1.05, 1.24) [M] 1.17 (1.07, 1.27) [S] 1.07 (1.02, 1.13) for natural uranium [S]
France, Gaseous diffusion [Z10]	281	Processing	Medium and high vs. no exposure	Natural soluble uranium compounds RR (95% CI): Medium RR=0.98 (0.71, 1.3) High RR=1.2 (0.85, 1.6)  Enriched uranium (n=45): Medium RR=0.96 (0.32, 2.9) High RR=0.84 (0.28, 2.8)  Depleted uranium (n=45): Medium RR=0.64 (0.23, 1.7) High RR=0.84 (0.32, 2.3)
<b>HEART DISEASE</b>				
Germany, Wismut [K14]	3 719 (all heart disease)	Mining	100 kBq/m <sup>3</sup>	ERR=-0.3 (95% CI: -0.6, 0.02)
France, CEA-COGEMA [R5]	72 (Ischaemic heart disease)	Mining	kBq/m <sup>3</sup>	ERR=-0.029 (95% n.e. (<0, 0.14) <sup>b</sup>
France, CEA-COGEMA [D24]	26 (Ischaemic heart disease)	Mining	kBq/m <sup>3</sup>	HR=0.94 (95% CI: 0.73, 1.20)
Germany [K18]	341 (Ischaemic heart disease)	Milling	100 kBq/m <sup>3</sup>	ERR=-0.09 (95% CI: -0.84, 0.65)

<i>Study references</i>	<i>No. of deaths</i>	<i>Nature of uranium work</i>	<i>Unit of uranium (LLR) exposure</i>	<i>Risk estimate per unit LLR exposure<sup>a</sup></i>
France, AREVA NC [G33]	48 (Ischaemic heart disease)	Processing	Reprocessed uranium, absorption Types M, S	HR (95% CI) Cumulative exposure duration (per year) 1.08 (0.97, 1.21) [M] 1.14 (1.03, 1.26) [S] 1.04 (0.99, 1.10) for natural uranium [S]  High cumulative exposure: 2.05 (0.53, 7.85) [M] 4.38 (0.47, 41) [S] 2.57 (0.82, 8.07) for natural uranium [S]  Cumulative exposure score: 1.12 (0.99, 1.27) [M] 1.17 (1.03, 1.33) [S] 1.13 (1.05, 1.22) for natural uranium [S]
France, Gaseous diffusion [Z10]	95 (Ischaemic heart disease)	Processing	Medium and high vs. no exposure	Natural soluble uranium compounds (with 95% CI): Medium RR=0.71 (0.39, 1.3) High RR=0.91 (0.53, 1.5)
<b>CEREBROVASCULAR DISEASE</b>				
Germany, Wismut [K14]	1 297	Mining	100 kBqh/m <sup>3</sup>	ERR=-0.05 (95% CI: -0.5, 0.6)
France, CEA-COGEMA [R5]	41	Mining	kBqh/m <sup>3</sup>	ERR=0.125 (95% CI: -0.06, 0.50)
France, CEA-COGEMA [D24]	16 <sup>c</sup>	Mining	kBqh/m <sup>3</sup>	HR=1.17 (95% CI: 0.90, 1.53)
Germany [K18]	171	Milling	100 kBqh/m <sup>3</sup>	ERR=-0.17 (95% CI: -1.14, 0.80)
France, AREVA NC [G33]	31	Processing	Reprocessed uranium, absorption Types M, S	HR (95% CI) Cumulative exposure duration (per year) 1.09 (0.93, 1.27) [M] 1.11 (0.95, 1.29) [S] 1.04 (0.97, 1.11) for natural uranium [S]  High cumulative exposure: 5.71 (1.48, 22) [M] 3.26 (0.97, 11.0) for natural uranium [S]  Cumulative exposure score: 1.13 (0.97, 1.31) [M] 1.16 (1.00, 1.35) [S] 1.01 (0.92, 1.12) for natural uranium [S]

<i>Study references</i>	<i>No. of deaths</i>	<i>Nature of uranium work</i>	<i>Unit of uranium (LLR) exposure</i>	<i>Risk estimate per unit LLR exposure<sup>a</sup></i>
France, Gaseous diffusion [Z10]	77	Processing	Medium and high	Natural soluble uranium compounds (with 95% CI): Medium RR=1.2 (0.66, 2.3) High RR=1.07 (CI: 0.6, 1.9)

<sup>a</sup> Risk estimation metrics: ERR (excess relative risk) for which zero represents no excess or deficit; HR (hazard ratio) and RR (relative risk or rate ratio) are expressed as a multiple of the rate in the baseline (lowest/no exposure) group. (ERR = RR – 1).

<sup>b</sup> n.e. = not estimable from the likelihood profile.

<sup>c</sup> A case-control subset of workers for whom information was available on radon and external gamma exposure and medical risk factors. Risk estimates were adjusted for those factors.

279. Studies of CSD/IHD/CeVD end points typically had greater statistical power than those for most cancer diseases because the numbers of CSD-related deaths were much larger than for most types of cancer. Other considerations arise; one might expect lesser statistical power to detect CSD because the consensus has been that the risk coefficients derived for external radiation of the circulatory system are several times smaller than for cancer induction. On the other hand, damage to the kidney, which is thought to be a primary target organ for uranium, affects the risk of heart disease, probably through the renin-angiotensin pathway. Results regarding CSD end points are also difficult to interpret because of the numerous medical and lifestyle factors that affect cardiovascular risk. The results of the French processing workers (AREVA NC) suggesting that uranium compounds with low solubility may induce CSD more than soluble compounds are somewhat puzzling. While less soluble uranium compounds are thought to confer more risk to the lung because of longer residence times, it is believed that more soluble compounds confer larger doses to most other organs than insoluble compounds do because of differences in biokinetics. If so, the results of the French processing workers (AREVA NC) are contrary to what one would expect for CSD, IHD and CeVD.

### (g) Conclusion

280. From the occupational exposure studies, a weak association of lung cancer risk with uranium exposure is concluded. However, currently available results are not consistent enough to demonstrate a causal association with uranium exposure. The results for leukaemia, other lympho-haematopoietic malignancies, digestive system cancers, kidney and other urological cancers and brain/CNS tumours did not provide clear evidence of uranium exposure-related risks. The results for non-malignant diseases—respiratory, cardiovascular and kidney diseases—also showed no relationship with uranium exposure. A number of studies without dose-response analyses for LLR exposure have provided null overall risk estimates for every health end point considered; while the negative SMRs are not very specific, at least they suggest the risks are likely to be small.

## 5. Limitations of occupational exposure studies

281. For uranium miners studies, recent developments enabled the calculation of organ doses and, therefore, estimation of the contribution of LLR from uranium ore. Studies published up to now have demonstrated a very small contribution of uranium to miner dose. Organ doses appear to be dominated by radon and radon decay products for lungs and by external gamma exposure for other organs. Demonstrating a potential risk associated to uranium, therefore, appears difficult.

282. Studies of uranium millers are limited in size, with the exception of the German Wismut miller study, which allowed assessment of individual radiation doses from uranium exposure [K18]. Undertaking analysis of combined cohorts after further development of organ dose calculation should improve results in the future.

283. Most studies of workers in the nuclear fuel cycle are limited by the difficulties in estimating the doses due to uranium internal contamination. Recent studies are the most meaningful since they have been based on more accurate exposure assessment and for some of them internal organ-specific absorbed doses were estimated by implementing the latest updates of the ICRP models and dosimetric tools. Nevertheless, improvement of dosimetric estimation is still needed to provide pertinent estimates of potential risks associated with uranium contamination. Segmentation between the different steps of the nuclear fuel cycle should enable improved assumptions regarding the solubility of the uranium compounds. The combined use of individual urinalysis dosimetry and of job exposure matrices may also allow improved characterization of radiation doses from uranium exposure and the quantification of related risks.

284. Natural uranium is not very radioactive ( $^{238}\text{U}$  decays very slowly) and its chemical properties are often such that any inhaled or ingested uranium is excreted rather quickly from the human body. Thus, studies of exposure to enriched or reprocessed uranium may be more informative. Some publications indicated that—even when the uranium doses are known—external exposure can dominate [L24]. In addition, most of these studies had major limitations (poor statistical power, no or imprecise estimates of doses, insufficient accounting for other exposure influences). Moreover, other exposure is mostly not taken into account, such as exposure to chemicals, heat and noise, which may also contribute to the increase of certain diseases.

285. Uranium worker data have often been limited to studies of male Caucasians. Quantitative generalization to women or other population groups is therefore uncertain. No occupational studies have attempted to examine genetic, epigenetic or metabolic susceptibility factors for uranium related diseases. Worker studies also provide no information about children, who may be more susceptible to the effects of uranium exposure than adults.

286. Continued follow-up of the principal uranium worker cohorts that have individualized worker exposure data will be valuable. Many members of the cohorts were relatively young at their most recent follow-up. Because mortality rates for many cancers increase as a power of age attained, these cohorts will become increasingly informative with future follow-up, providing greater ability to detect smaller effects and generate more precise risk estimates.

287. Since most studies have a limited number of uranium workers and relatively slight exposure for most of the workers, it is unlikely that epidemiological studies of individual nuclear facilities will have sufficient statistical power for a reasonable prospect to detect risks. Consequently, international pooled studies with high-quality, harmonized individual exposure estimates are likely to be necessary to assess uranium risks with high precision. However, studies of workers have advantages over those on environmental exposure of the public or of special groups (e.g. military personnel deployed in regions with potential DU exposure). The advantages particularly centre around having measurements to estimate individual uranium exposure levels, along with other occupational radiological exposure so they can potentially distinguish LLR exposure from other exposures. In addition, some of the studies had data on various chemical exposure at workplaces.



## B. Studies of Gulf War veterans

288. Depleted-uranium munition and armour were extensively used by the United States military in the first Gulf War in Iraq and Kuwait (Desert Storm) and again in the Balkans military action. Military personnel were exposed to DU via inhalation or wounds, notably due to friendly-fire incidents burning depleted-uranium-containing tanks and ammunition and clean-up operations [B26].

289. Several authors reported investigations on the Gulf war and the Balkan veterans, especially on United States, United Kingdom, Canadian, Danish and Dutch veterans [B28, M1, M2, S36, U11], which were reviewed by others [I20, L5, S6]. For example, the Institute of Medicine [I20] discussed extensively the results of about 25 studies on health outcomes following exposure to natural uranium and DU. The review integrated malignant (lung cancer, leukaemia, Hodgkin's and non-Hodgkin's lymphoma, bone cancer, renal cancer, bladder cancer, brain and other nervous system cancers, stomach cancer, prostatic cancer, testicular cancer) and non-malignant (renal disease, respiratory disease, neurological effects, reproductive and developmental effects, cardiovascular effects, genotoxicity, haematological effects, immunological effects, and skeletal effects) pathologies. They concluded that there was insufficient evidence to determine whether an association exists between exposure to uranium and the health outcomes cited above. However, the two following major limitations of the veteran studies were identified: (a) short period of follow-up and (b) poor assessment of uranium exposure.

290. The Royal Society comprehensively reviewed the use of DU, especially on the battlefield [R28]. The Royal Society concluded in its report that doses from DU were unlikely to be high, even in the most unfavourable (battlefield) conditions, so that lung cancer risks were unlikely to be more than doubled. The report indicated a potential non-radiological risk associated with exposure to DU, in particular with its nephrotoxicity. A summary of studies of the health status of veterans with potential or known exposure to DU is given in appendix A, table A5.

291. A recent study by Strand et al. aimed to investigate cancer incidence and also all-cause mortality in a cohort of Norwegian military present in Kosovo between 1999 and 2011 [S42]. Cancer incidence and mortality were studied from 1999 to 2011 and compared to national rates. The authors found no excess incidence of cancer except an elevated SIR for melanoma of the skin in men. All-cause mortality was half the expected rate (SMR=0.49; 95% CI: 0.35, 0.67).

292. A biennial health surveillance programme established for the United States Gulf War veterans has shown continuously elevated DU concentrations in urine among those with embedded fragments for over 20 years [M25]. No differences have been seen between the high- and low-exposure groups with regard to haematology, clinical chemistries, neuroendocrine parameters, bone metabolism, neurocognitive function, immune function, pulmonary function or nodules. Regarding renal function and injury, no high vs. low exposure differences were found for 16 clinical indicators of renal function, six urine markers for kidney injury, or four urine measures of low molecular weight proteins, except for two sensitive biomarkers of proximal tubule function that suggested subtle renal injury [M25].

293. In a study by Hines et al., some self-reported respiratory symptoms, mean pulmonary function values and prevalence of low-dose chest computed tomography abnormalities were compared in two populations of Gulf War veterans (high body burden group vs. low body burden) [H18]. The authors found no significant differences between the two groups, suggesting that DU levels inhaled during the 1991 fire incidents probably do not cause long-term adverse pulmonary health effects [H18].

294. In conclusion, several studies on the health pathologies among veterans with potential or no exposure to DU were published. Up till now, no clinically significant pathology related to DU has been found in the veteran's cohorts. The diversity of these studies in terms of topics has limited their

reproducibility, except for the biennial examinations of a small group of United States veterans with retained DU shrapnel in whom comprehensive examinations have consistently found no clinically adverse effects.

## C. Studies of environmental exposure

### 1. Living around uranium processing facilities

295. Numerous, mostly ecological, studies have been carried out to assess whether long-term residence in the vicinity of nuclear fuel cycle facilities or nuclear power plants affects the health of the residents. To focus on uranium effects, only studies carried out in population groups living around uranium processing facilities (after uranium mining and prior to electricity production) were examined. Eleven published studies were identified over the past ten years, which are presented in appendix A, table A6.

296. Because of potential bias, inability to check the validity of ecological results, and the lack of sufficient measurements of ambient uranium exposure levels, no firm conclusion could be drawn from ecological studies. Further, caution is required in interpreting ecological studies in general as causal inference is not warranted because of numerous limitations in their study design. The major limitation of ecological studies is the potential of ecological associations to misrepresent, sometimes greatly, the biological effect at individual level. Thus, an association observed between variables on an aggregate level does not necessarily mean that the same association will exist at individual level [G19].

297. Lane et al. reported a review of 13 epidemiological studies conducted in Port Hope, Canada in the past 30 years, including residents and workers [L7]. These studies included environmental measurements of the radiological and non-radiological contaminants, the estimation of the multi-pathway of exposure and also the health risks to the population, using environmental monitoring data or dose reconstruction methods based on a variety of approaches. The authors concluded that, taken together, the findings of these studies conducted on the Port Hope community indicated that observed adverse health effects were unlikely to be the result of exposure to environmental contaminants from radium and uranium processing. Other studies shown in appendix A, table A6 are also consonant with that conclusion.

### 2. Living in an environment affected by depleted uranium munition use

298. Some epidemiological studies attempted to determine if the health of populations living in countries or regions involved in the recent conflicts (i.e. Iraq, Kuwait, Bosnia and Herzegovina, Kosovo, Serbia and Montenegro) was affected by the use of DU in shrapnel or tanks. Iraq is the most studied country for investigation on possible effects of DU. Several publications aimed at describing the incidence and types of congenital malformations [A6, A7, S48] or birth defects [A3, B54, F1]. However, these publications failed to demonstrate a link between the increase in these pathologies and the environmental exposure to DU, notably due to the absence of evaluation of the exposure levels.

299. Few studies investigated cancer incidence in these populations. Al-Hashimi and Wang used in their study three sub-periods (1980–1990, 1991–2000, and 2001–2010), corresponding to the three Iraq wars, the Iran–Iraq war (1980–1988), the Gulf War I in 1991 and the Gulf War II in 2003 [A4]. The authors reported increases in the total number of cancer cases. However, the in-depth analysis indicated

a decrease in incidence rates in most cancer types when they were analysed statistically, considering population growth in the Ninawa province in the northern part of Iraq.

300. Another study aimed to describe changes in haematological malignancies (leukaemia and Hodgkin's lymphoma) in Croatian counties potentially exposed to DU in comparison to the pre-war period [L3]. This study did not find a significant difference in the incidence of these haematological malignancies.

301. In parallel to these health studies, measurements were made of daily urinary uranium excretion in German peacekeeping personnel (n=1,228) and unexposed subjects coming from the South of Germany (n=113) to assess potential intakes of DU [O1]. A daily urinary excretion of uranium of  $13.9 \pm 2.2$  ng/day (3 to 23 ng/day) measured for German peacekeeping personnel was similar to that of unexposed subjects ( $12.8 \pm 2.6$  ng/day).

### 3. Drinking water with elevated uranium levels

302. Possible health effects after long-term ingestion of uranium via drinking water was reviewed by Guseva Canu et al. [G32]. The description and main results for selected studies of the possible impact of elevated levels of uranium in drinking water are summarized in appendix A, table A7. This table notes potential uranium effects ascribable to its dual radiological and chemical toxicity. However, some studies related the effects to chemical toxicity only [K26, K27, K28, M9, S8, Z6], while other studies related to potential radiation effects [A32, K29, S7].

303. As shown in appendix A, table A7, most of the studies focused on the nephrotoxicity of uranium using cross-sectional study designs. In total, five studies were carried out: in Canada [M9, Z6, Z8]; in Finland [K26]; and in Sweden [S8]. The uranium concentrations in water were fairly similar in all the studies, with median concentrations in the range 20–30 µg/L among the exposed groups. All these studies, except the one from Mao et al. [M9], found no glomerular effect of chronic ingestion of uranium. Among people drinking water from private drilled wells, uranium exposure caused damage to the proximal tubule, shown by nephron reabsorption alteration [K26, S8, Z6] or tubular cytotoxicity [S8, Z1] was observed in four of the studies. Several biomarkers were measured in these studies (e.g. creatinine for glomerular filtration function at the early stage of renal injury) but none was specific for injury caused by uranium. Kurttio et al. [K29] carried out a case-cohort study in Finland of bladder and kidney cancer after long-term consumption of private well water containing uranium and its decay products. No association between the prevalence of these cancers and the uranium concentration in well water was found [K29].

304. Lymphatic and haematopoietic malignancies were considered in three studies [A32, S7, W23]. Seiler [S7] investigated whether 16 children with leukaemia in the City of Fallon, Nevada, United States, had higher levels of naturally occurring radioactive material in their well water compared to other inhabitants of the town. Water samples were collected in 2001 for the measurement of uranium, radon and gross alpha concentrations, and leukaemia cases were identified for 1997–2000. To resolve this potential time sequence problem, the authors also retrieved the 1989 citywide water analyses. The natural origin of the uranium present was confirmed by the calculation of the isotopic ratio. No difference was indicated in uranium concentration in the water drunk by the children compared to other inhabitants.

305. Witmans et al. [W23] compared the uranium concentrations in water between non-Hodgkin's lymphoma cases and their matched controls selected from the Saskatchewan (Canada) cancer registry. The cases had been exposed to significantly higher uranium concentrations in drinking water than the controls. However, uranium was one of 63 inorganic constituents tested in the study.

306. A case-cohort study by Auvinen et al. [A32] of Finnish adults that enrolled 35 cases of leukaemia also reported a negative result regarding exposure to naturally occurring uranium (and its decay products) in drinking water and leukaemia [A32]. The statistical power of the study was limited and no data on potential confounding factors were available. The risk of stomach cancer from exposure to naturally occurring radionuclides in drinking water was investigated. However, no association was found in this study.

307. Clinical studies in Nova Scotia, Canada performed on 324 persons exposed to variable amounts of naturally occurring uranium in drinking water (up to 0.7 mg/L) found no relationship with overt renal disease. Though there was a trend towards increasing excretion of urinary  $\beta$ -2 microglobulin with increasing concentration of uranium in well water, this was not seen in the group with the highest uranium well-water concentrations. This group had significantly reduced its consumption of well water by the time the measurements were made, supporting the hypothesis that the suspected tubular defect might well be rapidly reversible [M64, M65].

308. A pilot study by Mao et al. of three communities in Saskatchewan with mean uranium levels ranging from 0.71 (control) to 19.6  $\mu\text{g/L}$  found a statistically significant association ( $p=0.03$ ) between increasing but normal levels of urine albumin and the uranium exposure [M9]. Another Canadian study on two groups of subjects with chronic exposure to uranium in drinking water, the first group exposed to  $<1 \mu\text{g/L}$  and the other exposed to 2–781  $\mu\text{g/L}$  found no correlation with alkaline phosphatase and  $\beta$ -2 microglobulin in urine. The authors concluded that the uranium concentrations observed in the study affected the kidney function at the proximal tubule [Z6].

309. Another study by Zamora et al. [Z8] on chronic ingestion of uranium in drinking water demonstrated subtle changes in two of the indicators measured that were statistically significant—namely, glucose and LDH excretion concentrations. However, this did not result in any observable health effects (see also table 13). In addition, the change in LDH excretion was rather beneficial and was seen only in males. Thus, these changes are not nephrotoxic effects.

310. In conclusion, epidemiological studies of public uranium exposure to drinking water indicate that chemical toxicity of uranium may occur mainly in the kidneys and, in high concentrations, uranium may affect the kidney function. However, the functional alterations found in the kidneys were small and within normal limits, so the clinical significance of the findings may be minimal. The available literature focused on lymphatic and haematopoietic tissue malignancies is limited to three studies, which do not support a causal association between uranium exposure and those malignancies.

## IX. RESEARCH NEEDS

311. The estimation of organ doses from incorporated uranium isotopes depends on the availability of reliable biokinetic data and the construction of physiologically realistic biokinetic models. In general, good human and animal data are available for the construction of models. However, limited information is available on the age-dependence of organ retention and excretion rates, including information on the cross-placental transfer of uranium. In addition, more information is required on the distribution of uranium within tissues and cells, for example in CNS tissue and lungs.

312. Dosimetric models in general apply the same assumptions regarding source and target distributions within tissues to all internal emitters. For example, uranium isotopes and other radionuclides deposited in bone are assumed to accumulate on internal bone surfaces and/or in bone volume and target cells for cancer induction are assumed to reside along bone surfaces (bone cancer) and throughout red bone marrow (leukaemia). The validity of such assumptions requires further investigation, with consideration of the inhomogeneity of uranium distribution within tissues and cells.

313. Toxicological studies of uranium exposure are required to distinguish the chemical and radiological components of damage caused to cells and tissues, including short-term damage to organ function and longer-term effects including cancer. Comparisons of radionuclide toxicity and RBE determinations would assist in quantifying the potential health effects of uranium isotopes. Studies of the age-dependence of chemical and radiological toxicity would be valuable.

314. Future epidemiological studies require careful consideration of the acquisition of dosimetric data to assess individual organ and tissue doses for cohort subjects. A high priority would be a consortium effort by investigators to develop pooled data on uranium risks. The result could be considerable gains in the statistical power and precision of risk estimates that would potentially provide the best overall answers achievable as to health effects from uranium exposure. Pilot studies to quantify the magnitude of uncertainties in exposure assessment would ideally be part of this effort, so that sound estimates of dosimetric uncertainties could be incorporated into the risk modelling [L13, S21].

315. Concerning (molecular) epidemiology, setting up prospective follow-up or case control studies in selected subgroups, including collection of information on biomarkers, has the potential to provide more specific dose–response curves for defined subsets of cohorts and thereby improve knowledge of health effects in humans, including cancer and non-cancer diseases. High-throughput technologies (especially the -omics) would be relevant to apply to this field. However, proposed biomarkers will need to be rigorously evaluated as to their ability to improve exposure and risk assessment.

316. Mixed exposure should be taken into account when studying effects, such as other radionuclides (e.g.  $^{239}\text{Pu}$ ,  $^{222}\text{Rn}$ ), other chemical carcinogens (e.g. solvents, smoking, dust, silica, asbestos) and also the physical forms of uranium (solubility), e.g. through further development of exposure matrices in epidemiological research, and through animal studies.

317. Understanding the molecular mechanism of action of uranium on cells in culture and animal models, both as a metal and as a radionuclide, would be important in (a) facilitating the identification of bioindicators; (b) identifying portions of the molecular response that are attributable to the radiation response, the heavy metal response or both; and (c) defining the possible development of mitigators, (few mitigators for uranium exposure).

## X. GENERAL CONCLUSION

318. This annex provides a detailed review of sources and levels of uranium in the environment, exposure of the public and workers to uranium, biological effects of uranium, and epidemiological studies of nuclear workers and the public exposed to uranium.

319. Uranium is a naturally occurring radionuclide and is ubiquitously distributed in the environment. In daily life, people are exposed to uranium originating mainly from drinking water and foodstuffs. Average uranium levels in water vary between countries and within countries, with typical values of around 2 µg/L (~25 mBq/L of <sup>238</sup>U) in groundwater and 1 µg/L (~12.4 mBq/L of <sup>238</sup>U) in public water supplies. Some drinking water samples (<3%) may exceed the national or international guidelines set to prevent kidney toxicity. Concerning foodstuffs, potatoes, meat, fresh fish and bakery products are the main sources of uranium ingestion. The total daily intake from water and food consumption is around 1.5 µg/d (18.6 mBq/L of <sup>238</sup>U).

320. The main routes of entry of uranium into the body are inhalation and ingestion. The absorption to blood in each case is highly dependent on the chemical form (speciation) of the intake. For example, human data show that the absorption of ingested uranium is a few per cent of intake for soluble forms in water compared with substantially less than 1% for insoluble oxides. Human and animal data have been used to model the behaviour of uranium absorbed to blood, showing that the main site of retention is the skeleton, with lower amounts in soft tissues and rapid urinary excretion of a large proportion. The ICRP models make appropriate use of the available data.

321. Uranium is both a radioelement and a metal, and biological effects may result from the combined effects of the chemical element or species and the radiation. The radiological and chemical consequences of internal exposure to uranium depend partly on the route of intake (principally inhalation or ingestion), and the chemical form of the intake. Some effects are likely to be related to the chemical toxicity of uranium species, namely the renal effects, whereas others are rather related to radiological toxicity of uranium, including tumorigenic effects such as soft tissue sarcomas in rats and osteosarcoma in mice. In general, chemical effects are observed with short lag-times after exposure whereas radiological effects such as carcinogenesis have long lag-times.

322. Considering the chemical effects of uranium species, the kidneys are the most sensitive target organ. At higher levels, chemical effects of uranium are also observed in bones, indicating that uranium can induce effects on bone metabolism such as the impairment of bone growth and formation. Chemical effects of uranium have also been observed, in rodent studies, in liver, gonads, central nervous system, and the immune system. These experimental studies indicate that uranium induces biological effects in these organs, but the changes do not lead to the appearance of observable pathologies. While effects in these tissues may be seen at higher doses, damage to kidneys (and skeleton) is likely to be critical. Concerning the central nervous system, animal studies suggest that high doses of uranium may have some negative effects on the behaviour of animals. With the exception of kidney damage, animal studies showing toxicological effects have used concentrations of uranium substantially above those to which humans are exposed. No clinically significant pathologies have been found in the veteran cohorts potentially exposed to DU. Moreover, the biennial examinations of a group of United States veterans with retained DU shrapnel have found no clinically meaningful adverse effects.

323. Epidemiological studies of uranium miners and millers have included estimates of doses, showing the small contribution of uranium to overall doses and the dominant contributions of radon and radon decay products to lung dose and external gamma radiation for other organs. Most studies of nuclear workers are limited by difficulties in estimating radiation doses due to uranium. A weak association of lung cancer risk with uranium exposure is suggested but the currently available results are not

consistent enough to demonstrate a causal association. Results for other malignancies and non-malignant disease were also negative. The Committee concluded that epidemiological studies of public exposure to uranium in drinking water have reported small functional alterations in the kidneys, within normal limits and hence of minimal clinical significance.

## XI. ACKNOWLEDGEMENTS

The Committee wishes to acknowledge with gratitude the help of the experts E. Ansoborlo (France), Y. Gueguen (France), I. Guseva-Canu (France), D. Laurier (France), P. Lestaevel (France), F. Paquet (France), E. Rage (France), J. Harrison (United Kingdom) and R. Shore (United States), who were directly involved in preparing the evaluation, and S. Baatout (Belgium) for critically reviewing the manuscript. In particular, the Committee would like to thank I. Dublineau (consultant), who mainly elaborated this scientific annex based on a first draft prepared by K. Bundy (Canada), D. Chambers (Canada), R. Lane (Canada) and B. Thériault (Canada). The views expressed in this scientific annex remain those of the Committee and do not necessarily represent the views of individual experts, the United Nations or its Member States.





## APPENDIX A. TABLES SUMMARIZING URANIUM LEVELS IN WATER, STUDIES OF OCCUPATIONAL AND ENVIRONMENTAL EXPOSURE TO URANIUM

Tables A1 to A4 present uranium levels in water.

Tables A5 to A8 present four groups of occupational studies that provide increasing levels of information on uranium-specific risks.

Tables A9 to A11 present studies of risks from various sources of potential military and environmental exposure to uranium.



Table A1. Overview of uranium content in groundwater worldwide

The numbers in italics correspond to calculated data obtained from the mass activity of natural uranium of 25,400 Bq/g and from the relative proportion of <sup>238</sup>U (12.4 mBq/μg) in natural uranium of 48.3%; \* mean value (not median value); n.i: information not included in the study

<i>Continent</i>	<i>Country</i>	<i>Location</i>	<i>Sample number</i>	<i>Total uranium (μg/L)</i>	<i><sup>238</sup>U (mBq/L)</i>	<i>Reference</i>
Europe	Finland	n.i.	396	0.15 (<0.01–10)	1.84 (0.12–123)	[T22]
	Finland	South	13	285 (5.6–3 410)	3 504 (143–41 924)	[P28]
	Finland	South	288	1.5 (0.3–800)	19 (4–9 990)	[V4]
	Finland	South	194	28 (0.001–1 920)	344 (0.01–23 605)	[K26]
	Finland	South	167	2 (<0.01–1 770)	24.6 (<0.12–21 761)	[M67]
	Sweden	Värmland	153	6.7 (<0.20–470)	82.4 (<246–5 778)	[S8]
	Sweden	South	328	14.2 (<2–425)	177 (<27–5,293)	[I22]
	Norway	South	476	2.5 (–750)	31 (–9 300)	[F12]
	Poland	Swieradow	51	1.26 (0.2–2.4)	15.55 (2.4–29.4)	[K10]
	Spain	Catalonia	37	4.88 (<0.41–56.1)	60 (<5–690)	[O8]
	Switzerland	n.i.	5 548	0.77 (0.05–92.02)	9.5 (0.61–1 131)	[S33]
	France	Vals les Bains	n.i.	1.85 (0.55–3.6)	22.7 (6.8–44.3)	[M34]
	Greece	North	10	2.02 (0.15–7.66)	25.06 (1.82–95.3)	[S1]
North America	Canada	n.i.	n.i.	0.31 (0.16–6.23)	3.8 (2.0–76)	[L12]
	Canada	Kitigan Zibi, Quebec	32	39.25 (0.4–845.33)	470 (4.9–10 392)	[Z8]
	Canada	Southeastern Manitoba	287	10 (<0.02–2 020)	124 (<0.25–25 048)	[B21]
	Canada	Nova Scotia	20	0.39 (0.06–41.08)	4.8 (0.8–505)	[K19]
	USA	Connecticut	11	16.3 (0.21–1 166)	200 (2.6–14 335)	[M5]
	USA	Connecticut	35	157 (1.8–7 780)	1 930 (22.1–95 649)	[O5]
	USA	Cities with the largest average concentration	55 433	1.04 (0.03–1 945)	12.95 (0.37–24 124)	[C34]
South America	Brazil	Sao Paulo et Santa Catarina	78	0.28 (0.008–15.0)	3.4 (0.1–184.3)	[B43]
	Brazil	n.i.	358	1.2* (<0.01–7.5)	14.8 (0.12–92.2)	[G14]

<i>Continent</i>	<i>Country</i>	<i>Location</i>	<i>Sample number</i>	<i>Total uranium (<math>\mu\text{g/L}</math>)</i>	<i><math>^{238}\text{U}</math> (mBq/L)</i>	<i>Reference</i>
Africa	Morocco	n.i.	15	4.5 (0.37–25.1)	55 (4.5–309)	[H4]
	Ethiopia	Rift Valley	138	0.55 (0.005–48)	6.8 (0.06–590)	[R10]
	Egypt	Eastern desert	12	5.21 (1.19–519.4)	64.1 (14.6–6 386)	[D2]
	Ghana	North and coast	195	0.114 (<0.001–1.99)	1.4 (<0.01–24.4)	[R23, Z16]
Asia	Fujian Province	China	110 and 552	0.54 (0.03–13.4)	6.6 (0.4–164)	[Z16]
	Iran	Caspian Sea	27	2.2 (0.24–5.4)	27 (3–66)	[J5]
	Jordan	n.i.	n.i.	1.3 (0.5–6.7)	16.0 (6.6–82.4)	[V3]
	Bangladesh	West	67	2.5 (0.2–10)	30.7 (2.5–25.8)	[F14]
	Japan	Niigata	23	0.001 (0.0005–0.03)	0.018 (0.005–0.383)	[T14]
	India	Hisar	38	33.9* (5.3–113.5)	417 (65.2–1 395)	[G3]
	India	Kula area	15	0.83 (0.26–2.56)	10.2 (3.2–31.5)	[S27]
	India	Punjab	25	22 (2.65–74.98)	271 (32.6–922)	[K22]

Table A2. Overview of uranium content in surface water worldwide

The numbers in italics correspond to calculated data obtained from the mass activity of natural uranium of 25,400 Bq/g and from the relative proportion of  $^{238}\text{U}$  (12.4 mBq/ $\mu\text{g}$ ) in natural uranium of 48.3%; n.i.: information not included in the study

<i>Continent</i>	<i>Country</i>	<i>Location</i>	<i>Sample number</i>	<i>Total uranium (<math>\mu\text{g/L}</math>)</i>	<i><math>^{238}\text{U}</math> (mBq/L)</i>	<i>Reference</i>
Europe	Finland	Southern Finland	184	0.18 (0.08–34)	2 (1.0–420)	[V4]
	Finland	n.i.	152	0.099 (<0.01–0.92)	1.2 (<0.12–11.3)	[T22]
North America	USA	Cities with the largest average concentration	34.561	0.45 (0.03–1 737)	5.55 (0.37–21 534)	[C34]
South America	Argentina	n.i.	92	1.9 (<0.01–50)	23.4 (<0.12–615)	[B41]
Asia	India	Upper Siwaliks and Punjab	34	3.84 (1.08–19.68)	47.2 (13.3–242)	[S23]
	Iran	Ardabil	22	4.2 (2.1–13.6)	51.6 (25.8–167)	[H2]

Table A3. Overview of uranium content in public water supplies worldwide

The numbers in italics correspond to calculated data obtained from the mass activity of natural uranium of 25,400 Bq/g and from the relative proportion of <sup>238</sup>U (12.4 mBq/μg) in natural uranium of 48.3%; \* mean value (not median); n.i: information not included in the study

<i>Continent</i>	<i>Country</i>	<i>Location</i>	<i>Sample number</i>	<i>Total uranium (μg/L)</i>	<i><sup>238</sup>U (mBq/L)</i>	<i>Reference</i>
Europe	Finland	Southern Finland	951	1.25 (<0.01–1 770)	15.4 (<0.12–21 761)	[M67]
	Germany	Bavaria	461	0.9 (<0.01–39)	11.1 (<0.12–479)	[R3]
	Germany	National scale	564	3.2 (<0.7–320)	39.3 (8.6–3 934)	[B23]
	Germany	National scale	164	0.073 (0.00115–9.0)	0.90 (0.001–111)	[B24]
	Germany	National scale	36	2.0 (<0.16–60.2)	24 (<2–740)	[G2]
	Austria	n.i.	41	0.91 (0.06–79.2)	11.2 (0.72–975)	[G6]
	Austria	Waldviertel	48	1.1 (0.1–57.5)	14.05 (0.7–707)	[W5]
	Greece	Aksios, Kalikratia	23	3.46 (0.061–10.02)	42.5 (0.75–123)	[K7]
	Poland	Centre	26	0.39 (0.03–1.94)	4.8 (0.4–23.9)	[P20]
	Spain	Biscay	4	0.07 (0.003–0.24)	0.8* (0.04–2.9)	[H17]
	Italy	Rome	9	1.46 (0.02–8.37)	18 (0.3–103)	[J2]
	Norway, Sweden, Finland, Iceland	Several places	22	0.107 (0.0049–56.2)	1.32 (0.06–691)	[F13]
North America	USA	Illinois, Minnesota, Texas, Wisconsin	24	0.25 (0.1–13.2)	3.1 (1.23–162)	[L50]
South America	Argentina	12 provinces	145	0.4 (<0.01–21)	4.9 (<0.12–258)	[B41]
Africa	Morocco	National scale	6	0.75 (0.20–1.28)	9.25 (2.5–15.7)	[H4]
Asia	Islamic Rep. of Iran	Ardabil	3	7.6 (4.7–11.7)	93.4 (57.8–144)	[H2]
	India	Punjab		3.84 (1.11–19.68)	47.2 (13.6–242)	[S22]
	India	Punjab	45	10.4 (1.24–45.42)	260 (30–1 150)	[R8]
	India	Punjab		29 (2.5–313)	357 (30.7–3 848)	[S11]
	India	Himachal Pradesh	46	1.34 (0.56–10.11)	30 (10–260)	[R8]
	India	Western Haryana	23	17.03 (6.37–43.31)	209.4 (78.3–532)	[K1]
Oceania	Australia	West	23	0.19 (0–1.16)	2.3* (0–14.3)	[W7]
	Australia	West	173	0.06* (<0.001–1.40)	0.74 (<0.01–17.2)	[C1]

Table A4. Overview of uranium content in bottled mineral water worldwide

The numbers in italics correspond to calculated data obtained from the mass activity of natural uranium of 25,400 Bq/g and from the relative proportion of  $^{238}\text{U}$  (12.4 mBq/ $\mu\text{g}$ ) in natural uranium of 48.3%; \* mean value (not median); n.i: information not included in the study

<i>Continent</i>	<i>Country</i>	<i>Sample number</i>	<i>Total uranium (<math>\mu\text{g/L}</math>)</i>	<i><math>^{238}\text{U}</math> (mBq/L)</i>	<i>Reference</i>
Europe	Germany	908	0.17 (<0.0005–16.0)	2.09 (<0.006–197)	[B24]
	Germany	21	0.41 (<0.08–11.4)	5 (<1–140)	[G2]
	Spain	32	0.48 (0.04–5.8)	5.9 (0.5–70.9)	[D14]
	Slovenia	11	0.42 (0.09–4.3)	5.2 (1.1–53)	[B13]
	Italy	21	1.38 (0.20–9.92)	17 (2.5–122)	[R30]
	Italy	51	0.73 (<0.01–7.2)	8.97* (<0.17–89)	[D11]
	Poland	22	0.59 (0.06–0.86)	7.26 (0.75–10.54)	[C19]
	Croatia	12	0.53 (0.17–1.19)	6.55 (2.1–14.6)	[R29]
	France, Portugal, Spain	14	3.58 (1.79–40.7)	44 (22–500)	[M14]
	France	106	0.2 (<0.10–19)	2.25 (<1.3–230)	[A27]
	28 countries	132	0.23 (0.0002–27.5)	2.8 (0.002–338)	[K11]
	Austria	10	0.16 (0.012–5.4)	2.0 (0.15–66.4)	[W4]
	Norway, Sweden, Finland, Iceland	n.i.	0.102 (0.0055–32.4)	1.25 (0.07–698)	[F13]
South America	Argentina	62	1.9 (0.04–11)	23.4 (0.5–135)	[B40]
Africa	Tunisia	10	1.01 (0.13–2.14)	12.36 (1.56–26.36)	[G7]
	Morocco	10	0.54 (0.34–0.70)	6.6 (4.2–8.6)	[M48]
Asia	Kuwait	23	0.22 (0.05–2.04)	2.74 (0.63–25.07)	[A11]

Table A5. Studies of workforces that include workers (potentially) exposed to uranium though not explicitly identified

<i>Study references</i>	<i>Summary of study</i>	<i>Summary of findings relating to uranium</i>	<i>Relevance for this report</i>
Atkinson et al. [A29]	UKAEA employees, 1946–1996. 10,249 deaths. Dosimetry: external radiation doses. Neutron and tritium doses included when available. Internal doses noted but not quantitative	<u>All cancer</u> : external radiation exposure trend tests in those monitored for any internal exposure. Trends not significant for all cancer, stomach, colon, liver, pancreas, lung, bladder, kidney, brain  <u>Prostate cancer</u> : dose-response trend before 1980, but not 1980–1997 among those with internal monitoring, but uranium not examined	Not possible to derive uranium-specific risks, because uranium workers not analysed separately, and uranium-specific doses not used
Atkinson et al. [A30]	Further analysis of an extended UKAEA dataset [A29], conducted by time period to examine internal exposure for pre/post 1980 and prostate cancer. Excess associated with work with heavy-water reactors. Radionuclides of concern: <sup>3</sup> H, <sup>59</sup> Fe, <sup>51</sup> Cr, <sup>60</sup> Co, <sup>65</sup> Zn. Case-control prostate cancer substudy conducted	<u>Prostate cancer</u> : exposure levels at heavy-water reactors fairly constant over time, but no indication of elevated risk after 1980. So earlier excess with internal exposure probably not meaningful	Not possible to derive uranium-specific risks, because uranium workers not analysed separately, and uranium-specific doses not used
Carpenter et al. [C8]	Cancer mortality 1946–1988 among 75,006 UKAEA, AWE and BNFL employees. Uranium exposure not assessed	<u>All cancer</u> : analyses of external radiation plus tritium exposure	Not possible to derive uranium-specific risks, because uranium workers not analysed separately, and uranium-specific doses not used
Carpenter et al. [C9]	Cancer mortality 1946–1988 among 40,761 UKAEA, AWE or BNFL employees who had radionuclide monitoring	<u>All cancer</u> : separate analyses conducted for tritium, plutonium and other radionuclides. Insufficient detail about other radionuclides, so no uranium analyses	Not possible to derive uranium-specific risks, because uranium workers not analysed separately, and uranium-specific doses not used
Cragle et al. [C36]	Savannah River Plant (USA) conducted uranium processing, nuclear fuel fabrication and processing. Follow-up to 1980, 9,860 white male employees. 85% of exposure to external radiation; exposure to numerous internal radionuclides	Analyses by time of first employment and years of employment. Suggestion of elevated leukaemia risk in small subgroup of early workers, but uranium exposure not reported	Not possible to derive uranium-specific risks, because uranium workers not analysed separately, and uranium-specific doses not used
Fraser et al. [F10]	Cancer mortality and morbidity in UKAEA cohort of 39,718 during 1946–1986. Internal exposure noted for tritium, plutonium or other unspecified radionuclides	Cancer analyses conducted for external exposure, tritium, plutonium and “monitored for any radionuclide”	Not possible to derive uranium-specific risks, because uranium workers not analysed separately, and uranium-specific doses not used
Loomis and Wolf [L44]	Cancer mortality (1947–1990) among 6,591 white males at USA Oak Ridge Y-12 nuclear material production plant. Plant converted UF <sub>6</sub> to UF <sub>4</sub> to uranium metal which was fabricated and milled. Other exposure: beryllium, solvents, machine oils, mercury, lead	No measurements or estimates of uranium exposure, so no relevant analyses	Not possible to derive uranium-specific risks, because uranium workers not analysed separately, and uranium-specific doses not used
McGeoghegan and Binks [M28]	Mortality and cancer morbidity in 2,209 radiation workers at UK Chapelcross plant, 1955–1995. Main activity: operation of 450 MW Magnox gas cooled reactors	No measurements reported of internal exposure: only external radiation analysed	Not possible to derive uranium-specific risks, because uranium workers not analysed separately, and uranium-specific doses not used
McGeoghegan et al. [M29]	38,779 radiation and 15,040 non-radiation male workers at UK BNFL facilities (Sellafield, Springfields, Capenhurst, Chapelcross). Some workers had exposure to uranium, plutonium, tritium and other radionuclides	Investigated circulatory and other non-cancer diseases. No measurements of internal exposure, analysed external radiation exposure only	Not possible to derive uranium-specific risks, because uranium workers not analysed separately, and uranium-specific doses not used

Table A6. Studies of groups of workers identified and investigated as uranium workers but not monitored specifically for potential exposure to uranium, so uranium-specific doses were not available

Abbreviations: LLR, long lived radionuclide exposure, primarily from uranium

<i>Study references</i>	<i>Summary of study</i>	<i>Summary of findings relating to uranium</i>	<i>Relevance for this report</i>
Baysson et al. [B9]	Metallurgy department workers (N=356) of French CEA, 1950–1968 were studied for excess cancers (1950–1990), since workers believed there was a cancer cluster. Department research primarily on uranium metallurgy. Reconstructed external radiation doses; internal radionuclide and chemical exposure noted. Radionuclides: thorium, natural uranium/enriched uranium, some activation and fission products	255 handled radionuclides, principally natural uranium, mean exposure duration 11 years <u>All cancer</u> : suggestion of risk ( $p=0.13$ ) per year handling radionuclides, but stronger trend for handling chemicals <u>Multiple myeloma</u> : suggestive excess, but only 2 cases (0.2 expected, SMR=8.4, 90% CI: 1.4, 26). No evidence of cancer cluster	Study small, low statistical power. Analysis only for exposure to any radionuclide. Potential confounding by chemical exposure. Multiple myeloma results: small numbers, maybe a chance finding from multiple comparisons. Not possible to derive uranium-specific risks, because uranium doses not used
Boice et al. [B36]	Mortality in uranium miners and millers, Grants, New Mexico, 1979–2005: 1,735 underground uranium miners and 904 non-mining uranium millers. No measurements available on either radon or uranium exposure levels	Increased mortality in underground miners: lung cancer, non-malignant respiratory disease, liver cirrhosis. No significant excess among non-mining millers. Among uranium millers: Total cancer: SMR=0.89, n=65 Lung cancer: SMR=0.85, n=21 Cerebrovascular disease: SMR=1.06, n=14 Heart disease: SMR=0.84, n=73 Non-malignant respiratory disease: SMR=1.07, n=25 No suggestive excesses of kidney cancer, liver cancer or lymphoma, but small numbers	One of few studies of uranium millers. Study suggests uranium exposure effects are small or absent but not possible to derive uranium-specific risks, because uranium doses not used
Dupree-Ellis et al. [D33]	Mortality (1942–1993) investigated among 2,514 white male workers at Mallinckrodt (USA) uranium processing plant. Mean cumulative total dose, 47.8 mSv. For ~11 years plant also processed pitchblende, which increased external radiation exposure	<u>All cancer</u> : SMR=1.05 (95% CI: 0.93, 1.07). Some evidence of excess kidney cancer (ERR per Sv=10.5, 90% CI: 0.6, 57; n=10) in relation to external radiation exposure	Only total dose analysed, mainly external radiation. Not possible to derive uranium-specific risks, because uranium doses not used
Kreuzer et al. [K16]	Circulatory system disease (CSD) mortality (1946–2008, n=9,039 CSD deaths) in 58,982 male German Wismut uranium miners. External radiation estimated using a job exposure matrix	<u>Circulatory disease</u> : ERR per Sv for external gamma radiation: -0.13 for CSD, -0.03 for ischaemic heart disease, and 0.44 (95% CI: -0.16, 0.44) for cerebrovascular disease	Analysis for external radiation exposure only. Not possible to derive uranium-specific risks, because uranium doses not used



<i>Study references</i>	<i>Summary of study</i>	<i>Summary of findings relating to uranium</i>	<i>Relevance for this report</i>
Lane et al. [L8]	17,660 Canadian Eldorado uranium workers (Beaverlodge and Port Radium miners, Port Hope uranium refinery/processing). Radon decay product exposure, mortality (1950–1999) and cancer incidence (1969–1999)	Significant associations of radon decay product exposure and lung cancer mortality (n=618) in each subcohort. No associations for any other cancers. No estimates of LLR risk	Analysis for radon decay products only. Not possible to derive uranium-specific risks, because uranium doses not used
McGeoghegan and Binks [M27]	Mortality and cancer incidence at UK Springfields uranium production plant, 1946–1995. Main activities, uranium fuel fabrication and UF <sub>6</sub> production. 13,960 radiation workers	No measurements of internal exposure; all analyses for external radiation exposure	No analyses of internal exposure. Not possible to derive uranium-specific risks, because uranium doses not used
McGeoghegan and Binks [M26]	Mortality and cancer incidence studied at UK Capenhurst plant, 1946–1995. Main activities, uranium enrichment for military or power plant purposes. 12,540 employees	No measurements of internal exposure; all analyses for external radiation exposure	No analyses of internal exposure. Not possible to derive uranium-specific risks, because uranium doses not used
McGeoghegan et al. [M30]	407 workers involved in 1957 Windscale uranium pile fire. Mortality and cancer incidence 1957–2007. Estimated plutonium, but not uranium, doses	No measurements of internal exposure; only external radiation analyses	No analyses of internal exposure. Not possible to derive uranium-specific risks, because uranium doses not used
Pinkerton et al. [P21]	Mortality of 1,484 men employed in 7 uranium mills in Colorado Plateau, USA (1940–1998). Mortality (SMRs) examined by duration of employment and time since first employment	No individual estimates of radiation exposure were made	No data available on internal exposure. Not possible to derive uranium-specific risks, because uranium doses not used
Rooney et al. [R22]	Nested case-control study in five UKAEA facilities of incident and fatal prostate cancer and exposure to radionuclides. 136 prostate cancer cases diagnosed 1946–1986 and 404 matched controls. 28 (21%) prostate cancer cases and 46 (11%) controls had potential exposure to <sup>3</sup> H, <sup>51</sup> Cr, <sup>59</sup> Fe, <sup>60</sup> Co and/or <sup>65</sup> Zn	<u>Prostate cancer</u> : risk increased with duration and concentrations of exposure to the targeted radionuclides (possible exposure RR: 2.36, 95% CI: 1.26, 4.43; documented exposure RR: 5.32, 95% CI: 1.87, 17.2)  Indicated prostate cancer not associated with uranium exposure; but uranium exposure was rare. Found 0 cases and 6 controls with documented uranium exposure (RR=0, 95% CI: 0, 2.55)	Negative association with uranium exposure (yes/no). Not possible to derive uranium-specific risks, because uranium doses not used
Vacquier et al. [V1]	French CEA-COGEMA uranium miners (1946–1990) followed up through 1999, mean 30.1 years. Radon exposure estimates from ambient monitoring and worker job, location and year. LLR exposure not estimated	Elevated SMRs for total cancer (SMR=1.19), lung cancer (SMR=1.43) and kidney cancer (SMR=2.00), but not leukaemia. Significant radon dose response for lung cancer, but not kidney cancer or leukaemia. No analyses with regard to LLR exposure	Not possible to derive uranium-specific risks, because uranium doses not used
Walsh et al. [W6]	Radiation dose and prostate cancer mortality examined in the 1970–1990 subset (55,435 miners) of German Wismut uranium mining cohort. Follow-up, 1970–2003, n=263 prostate cancer deaths. Only gamma dose analysed	External gamma dose response: ERR per Gy=–1.18 (95% CI: –2.4, 0.02)	Study analysed external dose and prostate cancer mortality. Not possible to derive uranium-specific risks, because uranium doses not used

Table A7. Studies of workers monitored for potential exposure to uranium, with occupational dose records, but uranium-specific doses not explicitly analysed

<i>Study references</i>	<i>Summary of study</i>	<i>Summary of findings relating to uranium</i>	<i>Relevance for this report</i>
Boice et al. and Ritz et al.[B38, R16]	46,970 employees, Rocketdyne, USA (1948–1999); 5 801 had radiation exposure, 2,232 monitored for internal radionuclides. Mortality follow-up 1948–2008 (mean 33.9 years). Activities: operating research nuclear reactors, fabricating nuclear fuel, disassembling and decontaminating reactor facilities, decladding spent nuclear fuel and storing nuclear material. Intakes of 14 radionuclides calculated for 16 organs using ICRP biokinetic models; >30,000 urinalyses. Most significant internal exposure was from enriched uranium, especially for lung and kidney. A few workers received high lung doses (~0.3 Sv) but 87% of workers had committed equivalent dose to all tissues well below 10 mSv	For those monitored for internal exposure, no SMR excesses seen for any cause: all cancers (except leukaemia); leukaemia; cancers of lung, kidney, stomach, liver, prostate, brain; heart disease and cerebrovascular disease Uranium doses, RR at 100 mSv: All cancer except leukaemia: 0.98 (95% CI: 0.82, 1.17, n=266) Lung cancer: 1.01 (CI: 0.89, 1.16, n=94) Non-CLL leukaemia: 1.06 (CI: 0.50, 2.23, n=10) Other trends for internal (mainly uranium) exposure: non-significant increasing trends, cancers of stomach, kidney, brain/CNS, lymphomas; Non-significant decreasing trends, cancers of colorectum, pancreas, prostate, bladder, and non-malignant respiratory disease	Sufficient data to estimate internal radionuclide exposure on basis of urinalyses. Uranium was largest contributor to internal dose but other radionuclides also present. Study limitations: relatively low career doses, incomplete information on smoking. Study does not suggest any strong uranium risk but has uncertainties regarding uranium doses and small numbers of deaths
Dufey et al. [D30]	Leukaemia nested case-control study in cohort of 58,987 German Wismut male uranium miners, 1946–2003; 128 leukaemia cases (40 CLL and 88 non-CLL) and unspecified number of controls. Mining performed 1946–1989. Cohort mean dose 48.8 mGy, of which external gamma contributed 40.9 mGy	<u>Leukaemia</u> : analyses for total dose to red bone marrow. For a 2-years lag, linear ERR per Gy was 1.39 (90% CI: -0.77, 3.56) for all leukaemia and 2.08 (-0.84, 4.99) for non-CLL. Suggestion of increased non-CLL only for the highest dose group: for 0.4, 5.0, 25.6 and ≥103.7 mGy RRs were 0.53, 0.89, 0.67 and 1.25 (90% CI: 0.69, 2.20), respectively	Strengths included large cohort, long and high quality follow-up. However, no assessment of LLR uranium exposure, so study uninformative regarding uranium effects
Dufey et al. [D31]	Liver cancer mortality (n=159) in cohort of 58,987 male German Wismut uranium miners, 1946–2003. Mining 1946–1989. Average liver dose, 47.9 mGy low-LET and 2.4 mGy high-LET irradiation; mean high-LET liver dose: 2.1 mGy from radon/progeny and 0.8 from LLR. Arsenic measurements available	<u>Liver cancer</u> : the analysis by high-LET dose categories did not reveal any statistically significant elevations in risk, and dose-response analysis, adjusting for low-LET dose, age and calendar years, yielded ERR per Gy=48.3 (95% CI: -32, 129). Examined confounding factors including arsenic exposure and alcoholism	Analysis adjusted for low-LET radiation exposure, but did not account for radon decay product exposure. Contribution of LLR to total absorbed liver dose was <2%, so study provides little information regarding uranium risk
Dupree et al. [D34]	995 white male employees (1943–1949) of Linde, USA uranium processing company followed up 1943–1979. Doses reconstructed from ambient monitoring data, surface contamination, urinalysis and film badges. Exposure mainly to uranium with low solubility. Job exposure was categorized as <10, 10–100 and >100 mSv/y of internal exposure (which was greater than external exposure levels)	Elevated SMRs found for laryngeal cancer (SMR=4.47, 95% CI: 1.4, 10.4, n=5), arteriosclerotic heart disease (SMR=1.19, CI: 1.01, 1.39, n=159) and non-malignant respiratory diseases (SMR=1.52, CI: 1.04, 2.14, n=32). No excess risk seen for lung, colorectal or lymphohaematopoietic malignancies. No analyses by uranium exposure levels	No quantitative analyses by uranium exposure levels, so uninformative regarding uranium risk. Given the exposure information developed, cohort has some potential to contribute to future uranium risk assessment

<i>Study references</i>	<i>Summary of study</i>	<i>Summary of findings relating to uranium</i>	<i>Relevance for this report</i>
Guseva Canu et al. [G31]	Cancer mortality (1968–2005) examined in 2,709 male workers at French AREVA NC Pierrelatte uranium enrichment and conversion plant. 15 former uranium miners excluded. Uranium assessments: individual dosimetry badges; faecal/urine bioassays and in vivo measurements performed but not available	<u>All cancer</u> : the SMR=0.70 (95% CI: 0.60, 0.81, n=193) <u>Lymphoma and rectal cancer</u> : non-significant increases in rectal cancer (SMR=1.48, n=10) and non-Hodgkin's lymphoma (SMR=1.32, n=8). Trend analyses by time first employment and length of employment not significant for all cancer, lung cancer, upper aerodigestive tract cancer, and lympho-haematopoietic malignancy	Mortality in relation to internal radiation dose not reported, so study uninformative regarding uranium risk
Kreuzer et al. [K15]	Stomach cancer mortality (1946–2003; n=592) in 58,677 male German Wismut uranium miners and exposure to external radiation, alpha radiation, fine dust with silica and arsenic. Mean estimated LLR exposure, 4.1 kBq/m <sup>3</sup> (<0.05 mGy), was substantially correlated with arsenic exposure	<u>Stomach cancer</u> : for alpha irradiation, ERR per Gy=22.5 (95% CI: -27, 72) with statistical adjustment for other exposure variables. RR in highest alpha dose category (10–26 mGy) not significant: 1.59 (CI: 0.69, 2.49)	Not analysed for LLR exposure. Only <1% of the alpha dose to the stomach due to LLR, so uninformative regarding a uranium risk
Mohner et al. [M52]	Nested case-control study of leukaemia mortality (1953–1998) among ~360,000 male German Wismut uranium miners. 377 leukaemia deaths and 980 controls matched on age. Cumulative red bone marrow (RBM) doses from external radiation, radon decay products, LLR and occupational medical diagnostic radiation (including 17,578 X-ray examinations), using a detailed job exposure matrix. Mean cumulative LLR RBM dose estimated to be <0.05 mGy	Added analysis of medical X-ray exposure to occupational radiation sources. Analyses were conducted only for total occupational RBM radiation exposure, both internal and external and for medical X-rays. Case-control analyses for LLR already reported in [M50]	Report is uninformative for assessing uranium risk since analyses were of all radiation exposure combined
Polednak and Frome [P24]	18,869 white males worked at the Oak Ridge TEC uranium conversion and enrichment plant (operated 1943–1947) but not at the Y-12 plant which succeeded it. Workers in some departments (e.g. chemical dept.) exposed to high ambient uranium dust. In 1945 average levels of uranium in air in various departments ranged from 25 to 300 µg/m <sup>3</sup> . Among 226 men with urine samples, 72% had >0.01 µg/ml and 33% >0.05. Mortality 1943–1977	Elevation in lung cancer (SMR=1.22, 95% CI: 1.10, 1.36) but not higher among those working in areas with more uranium dust or those with longer employment. Mortality not elevated for stomach cancer (SMR=0.73), kidney cancer (SMR=0.75), bone cancer (SMR=0.90) or leukaemia (SMR=0.92)	Individual measurements of uranium exposure levels available for only an undefined subsample of workers, so dose-response analyses not conducted. Smoking information not available

<i>Study references</i>	<i>Summary of study</i>	<i>Summary of findings relating to uranium</i>	<i>Relevance for this report</i>
Rage et al. [R4]	Lung cancer mortality (1956–1999) studied among 3,377 French uranium miners hired ≥1955 when LLR and gamma ray measurements became available. Among 2,745 with exposure to uranium, mean was 1.63 kBq/m <sup>3</sup> (maximum 10.36). LLR contributed only 1.3% of total alpha-particle lung dose. Annual lung dose due to LLR significantly correlated with doses from low-LET radiation (r=0.49), radon gas (r=0.53), and radon decay products (r=0.50)	<u>Lung cancer</u> : significant risk lung cancer mortality associated with total absorbed lung dose (ERR per Gy=2.94, 95% CI: 0.80, 7.53, n=66) and the alpha-particle absorbed dose (ERR per Gy=4.48, CI: 1.27, 10.9). Assuming RBE=20 alpha-particles, ERR per Gy for total weighted lung dose was 0.22 (CI: 0.06, 0.53). LLR ERR was 5.0 (CI: 1.2, 12.3) per 10 mGy	Statistical analysis of LLR provided only weak information; since LLR were correlated with and a small percentage of total exposure the LLR risk estimate may be inaccurate. No information on smoking habits. Therefore study provides little information regarding uranium risk
Zablotska et al. [Z1]	Mortality (1950–1999) and cancer incidence (1969–1999) of Port Hope, Canada radium and uranium process workers. 2,472 (87% males) worked only with uranium. Gamma was predominant radiation exposure, so analyses were of gamma and radon decay products (RDP), not of LLR. Urinalysis for uranium begun in early 1960s; alpha counting of urine samples for workers exposed to enriched uranium conducted on a limited basis, so not used in dose assessment	No significant elevations in various cancer SMRs. No excess cancer incidence seen for a number of cancer types or all cancer. Dose-response analyses reported for RDP and external gamma. In uranium workers, lung cancer RDP risk estimate non-significantly elevated. Other malignancies and circulatory diseases: no significant dose related elevations in risk for either RDP or external exposure	Study of uranium workers was negative, other than a weak association of RDP exposure and lung cancer incidence (but not mortality). Had no LLR exposure estimates, so analyses of uranium effects could not be presented. Substantial uncertainties: limited or no exposure information for early workers, lack of smoking information. Study uninformative regarding uranium exposure risk

Table A8. Studies of workers monitored for potential exposure to uranium for whom uranium-specific doses have been used in analyses so that uranium risks can be explicitly examined

Abbreviations: LLR, long lived radionuclides; n.e., not estimable

Study references	Summary of study	Summary of findings relating to uranium	Relevance for this report
Carpenter et al. [C7]	Case-control study of brain/central nervous system (CNS) cancer deaths in workers (1943–1977) at 2 nuclear facilities at Oak Ridge (ORNL and TEC/Y-12): enrichment of <sup>235</sup> U and conversion to UF <sub>4</sub> (TEC, 1943–1947); fabrication and testing of components for nuclear weapons (Y-12); nuclear energy technology R&D (ORNL). 72 male and 17 female brain/CNS cancer deaths (1943–1979). 4 matched controls per case. Work locations/years rated by industrial hygienist for levels of 26 agents, including uranium compounds	<u>CNS cancer:</u> 63% of brain/CNS tumours were malignant glial tumours. Ever exposed to uranium, odds ratio (OR)=1.06 (95% CI: 0.5, 2.3, p=0.88) with no exposure lag, or 0.94 with a 10 years lag. Lagged levels of graded uranium exposure (grades 1, 2 and 3, with 0=no exposure as referent) had non-significant ORs of 0.88, 1.01 and 0.70, respectively. Analysis by duration of heavier uranium exposure (grades 2–3, 10 years lag) showed: OR=0.86 for 1–3 years; 0.79, 3–10 years; 0.99, 10–20 years; 1.63, >20 years (n=3), not significant	Only semi-quantitative imputation of amount of exposure. No elevated risk was apparent, but the reliability of dose categories unclear. Limited information regarding uranium risk for brain/CNS tumours
Chan et al. (and supplement) [C17]	Mortality among 6,759 workers at Paducah Gaseous Diffusion Plant, USA studied for 1952–2003. Workers had potential exposure to external and internal radiation, uranium, several other metals, trichloroethylene and other chemicals. Urinalyses of uranium used to characterize the cumulative dose of internally deposited radionuclides as µg.years	RRs for different uranium exposure quartiles compared to exposure quartile (<21 µg.years) are provided in table 15 (lung cancer); table 17 (leukaemia and non-Hodgkin’s lymphoma); table 18 (pancreatic cancer); table 20 (brain/CNS cancer)	Provides grouped quantitative information about the health effects of uranium exposure, though LLR linear dose-response risk coefficients were not given. Possible confounding by chemicals and smoking. Provides semi-quantitative information regarding uranium risk for several cancer sites
Checkoway et al. [C20]	Mortality (1947–1979) investigated among 6,781 white male workers at Y-12 uranium fabrication plant (Oak Ridge, USA). 3,490 monitored for internal exposure. Internal dosimetry: urine analyses begun in 1950, fully implemented by 1953, and in vivo measurements added in 1961. Internal lung doses calculated using metabolic models. For monitored workers, mean lung dose 82.1 mSv. Mean external dose, 9.6 mSv. Other exposure: beryllium, solvents, machine oils, mercury, lead. 45 lung cancer deaths in those monitored for uranium exposure	<u>Lung cancer:</u> (n=45) Analysis with 10-years dose lag for alpha irradiation, compared to 0–<10 mSv group, 0–49 mSv, RR=0.93 (95% CI: 0.41, 2.12) 50–99, RR=0.66 (CI: 0.23, 1.90) ≥100, RR=1.12 (CI: 0.47, 2.65, n=11) <u>Brain/CNS cancer:</u> (n=14) with no lag, 10–49 mSv, RR=1.10 (0.19, 6.5) ≥50 mSv, RR=0.45 (0.06, 3.2) <u>Other cancers:</u> no bone cancers observed. Trend analyses for kidney cancer (n=6) or other a priori cancers not reported for uranium monitored cohort	Provides some information on lung cancer among those with measured uranium exposure; showed little apparent risk. Small numbers of lung and other cancers limit the quantitative estimates. Smoking information not available. Provides semi-quantitative information regarding uranium risk for lung and brain/CNS cancers

Study references	Summary of study	Summary of findings relating to uranium	Relevance for this report
Drubay et al. [D24]	A case-control study of circulatory system disease (CSD, n=442) mortality, particularly ischaemic heart disease (IHD, n=167) and cerebrovascular disease (CeVD, n=105), and 237 matched controls, nested among 5,086 French CEA-COGEA uranium miners who were first employed after 1955, followed up through 2007, mean 35.4 years. Individual exposure estimated from ambient monitoring, 1959–1982 and dose reconstruction for 1956–1958. Since 1983, individual LLR exposure estimated with film dosimeters. Mean cumulative LLR was 1.2 kBq/m <sup>3</sup> (max=7.6)	<p><u>Circulatory disease</u>: statistically significant association of radon exposure with both CSD (hazard ratio (HR)=1.11/100 WLM) and CeVD (HR=1.25/100 WLM) risk. Records contained information on a number of medical CSD risk factors for a subset of cases and controls. After adjusting for radon and external gamma exposure and for empirically the main medical risk factors, found LLR HRs per kBq/m<sup>3</sup> of:</p> <p>CSD: 1.13 (95% CI: 0.97, 1.31, n=76)</p> <p>IHD: 0.94 (CI: 0.73, 1.20, n=26)</p> <p>CeVD: 1.17 (CI: 0.90, 1.53, n=16)</p> <p>LLR risks in entire nested case-control sample, but without being able to adjust for medical risk factors, nearly identical</p>	Had a substantial set of individual measurements of LLR exposure. After adjusting for radon and external radiation, detected no significant LLR risk for CSD, IHD or CeVD. Confounding by medical CSD risk factors proved to be small. Uncertainties: exposure prior to 1983 estimated from ambient measurements or with no measurements may have had appreciable measurement error. Relevant for uranium risk assessment of CSD
Drubay et al. [D23]	Kidney cancer mortality in 3,377 French uranium miners 1956–2007, and 58,986 German uranium miners 1946–2007. For respective French and German cohorts, median durations of follow-up were 30.0 and 34.8 years; respective median kidney doses were 26.7 mSv (range 0, 498) and 34.4 mSv (range 0, 2 905)	<p><u>Kidney cancer</u>: SMRs were 1.49 (95% CI: 0.73, 2.67, n=11) for French cohort and 0.91 (CI: 0.77, 1.06, n=174) for German cohort. A 10-years lagged LLR dose-response analysis showed hazard ratio (HR) per kBq/m<sup>3</sup> with 10-years lagged cumulative dose of 0.89 (CI: 0.55, 1.42) for the French and 1.009 (CI: 0.991, 1.027) for the German cohort</p>	Lack of association with estimated LLR exposure suggests kidney cancer effect is likely small. Uncertainties: no information about smoking; French cohort was small; workers also had radon and external gamma exposure
Dupree et al. [D35]	Nested case-control study of lung cancer mortality (787 cases with 787 matched controls) in cohorts at 4 USA uranium processing facilities: TEC (operated 1943–1947 only) and Y-12 (1947–1982), Mallinckrodt (MCW, 1942–1966) and Fernald (FMPC, 1947–1982). Maximum follow-up period, 1943–1983. Primary radiation hazard was from airborne dust of mainly insoluble natural uranium compounds. For FMPC, MCW and TEC, ambient uranium monitoring to estimate internal radiation doses. Y-12 also had whole body counting and urinalysis. Conversion to doses assumed Type S uranium exposure. Smoking status available for 48% of cases and 39% of controls	<p><u>Lung cancer</u>: analysis of internal radiation (primarily from ambient uranium), using 10-years lagged dose with &lt;0.5 mGy as baseline, showed no increased risk for workers exposed below 250 mGy. Lung cancer odds ratios (ORs) for 0.5, 2.5, 5, 25, 50, &gt;250 mGy were 1.03, 0.57, 0.85, 0.82, 0.64 and 2.05 (95% CI: 0.20, 21), respectively for LLR. However, for the 166 case-control pairs with smoking data, no elevation in risk (odds ratio of 0.36 in the highest internal dose group)</p>	Analysis had large number of lung cancer deaths, a fraction had urinalyses and/or whole body counting in addition to ambient monitoring data. Suggests that effect of uranium exposure must be small. Estimate of ERR per Gy not reported, but the grouped dose data do not suggest a statistically significant elevated lung cancer risk. Limitations: uncertain dose estimates for early workers, concomitant exposure to radon and external radiation, and limited smoking information. Provides semi-quantitative information regarding uranium risk for lung cancer

<i>Study references</i>	<i>Summary of study</i>	<i>Summary of findings relating to uranium</i>	<i>Relevance for this report</i>
Guseva Canu et al. [G31]	Lung cancer mortality in 2,709 workers at the French AREVA NC Pierrelatte uranium reprocessing plant during 1960–2005. The plant enriched uranium via gaseous diffusion caused uranium chemical conversion. Uranium was only radioactive material used at the plant. Semi-quantitative JEM to characterize uranium exposure (duration and intensity specific for each job and calendar year, on a 4 point ordinal scale). Smoking data on 6% of cohort	<u>Lung cancer:</u> (n=48) for durations of exposure >1 year to Type F, M and S uranium compounds found hazard ratios (HRs) of 1.05 (95% CI: 0.43, 2.52), 2.61 (0.87, 7.8), 2.58 (0.76, 8.8), respectively. For duration of exposure as a continuous variable, HRs of 1.01 (0.96, 1.01), 1.07 (1.01, 1.13) and 1.07 (1.01, 1.14) per year exposure, respectively	Suggestions of elevated lung cancer risk after exposure to slowly soluble (Types M and S) uranium compounds. However, substantial uncertainties: small number of lung cancer cases, only an ordinal scale of exposure intensity, limited smoking information, no individualized information on chemical exposure. Provides semi-quantitative information on uranium risk for lung cancer, with analyses by uranium solubility, but uncertainty due to small numbers
Guseva Canu et al. [G32]	Quantified uranium exposure using a job exposure matrix for 2,897 workers at French AREVA NC Pierrelatte uranium reprocessing plant. Classified exposure by natural vs. reprocessed uranium, and by solubility Types F, M and S. To model cumulative exposure for individuals, estimated duration and intensity of exposure to Types F, M and S	<u>Lung cancer:</u> (n=53) For natural uranium exposure, no significant associations for Type F, M or S. For reprocessed uranium, significant hazard ratios (HRs) in the highest cumulative exposure group of 4.35 (95% CI: 1.25, 15) for Type M and 10.5 (CI: 2.3, 48) for Type S. Dose-response analysis for reprocessed uranium exposure duration gave HRs of 1.13 (1.03, 1.25) and 1.13 (1.01, 1.25) for Types M and S, respectively. Analysis in subgroup of 345 workers with smoking information suggested no confounding by smoking  <u>Lympho-haematopoietic malignancies:</u> (n=21) Found association with insoluble reprocessed uranium, but on the basis of only 3 exposed cases	This exploration of chemical types and radioactivity level of various forms of uranium suggests that natural uranium has little or no lung carcinogenic effect. However, the less soluble forms of reprocessed uranium dust, with their greater radioactivity and relatively long residence time, may induce lung cancer  Limitations: study size was small. Only limited smoking data available. Results require confirmation in larger independent study
Guseva Canu et al. [G33]	Mortality from ischaemic heart disease (IHD, n=48), cerebrovascular disease (CeVD, n=31) and total circulatory system diseases (CSD, n=111) after chronic exposure to uranium among 2,897 workers at the French AREVA NC Pierrelatte uranium processing plant (1960–2006). Cumulative exposure to various uranium compounds was classified by isotopic composition and solubility type and quantified for individual job histories via a job-exposure matrix (natural vs. reprocessed uranium (RPU), and absorption Types F, M and S)	<u>Circulatory disease:</u> CSD mortality was increased among workers exposed to Type S RPU (HR=2.13, 95% CI: 0.96, 4.70) and Type S natural uranium (HR=1.73, CI: 1.11, 2.69). Additional information on risk by duration and intensity of exposure for CSD, IHD and CeVD is given in the text of table 20  For the subset of workers with available smoking data they found nominally higher CSD HRs for RPU Type M and S exposure among smokers than non-smokers, but numbers of cases were small	Job exposure matrix was carefully done, but provides only an approximate quantitation of uranium exposure. Concerns with study are: small study size, limited smoking data. Possible confounding: heat and trichloroethylene exposure were correlated with uranium exposure. The analyses of Types M and S RPU exposure did not adjust for the common exposure to Type F and natural uranium. Provides semi-quantitative information regarding uranium risk for CSD, including analyses by uranium solubility and isotopic composition, but with uncertainty due to small numbers

Study references	Summary of study	Summary of findings relating to uranium	Relevance for this report
Kreuzer et al. [K14]	Circulatory system disease (CSD) mortality (1946–1998), German Wismut male uranium miner cohort in relation to external radiation, radon and LLR exposure. Exposure estimated via a job exposure matrix JEM for each radiation type, 1946–1989. 5,417 deaths from CSD (1946–1998), including 3,719 from heart disease and 1,297 from cerebrovascular disease. Mean LLR exposure, 3.5 kBq/m <sup>3</sup> (maximum 132)	<p><u>Circulatory disease:</u> analyses for cumulative LLR exposure lagged by 5 years. The LLR risk estimates (ERR per 100 kBq/m<sup>3</sup>) were</p> <p>CSD: –0.2 (95% CI: –0.5, 0.06)</p> <p>Heart disease: –0.3 (CI: –0.6, 0.02)</p> <p>Cerebrovascular disease: –0.05 (CI: –0.5, 0.6)</p> <p>In no case did the highest dose category show significantly elevated risk. Ischaemic heart disease (n=2,690) also did not show a statistically significant elevation</p>	The largest systematically defined cohort of uranium workers available. Uncertainties: no confirmation of JEM by urinalyses, correlation of LLR exposure with external radiation and radon exposure not accounted for, lack of dosimetric models to estimate LLR exposure of the heart and major arteries
Kreuzer et al. [K17]	Mortality from cancer of the extra-thoracic airways among 58,690 male German Wismut uranium miners (1946–2008) in relation to radon and cumulative LLR exposure. LLR exposure estimates derived by a job exposure matrix based on ambient measurements as described in Kreuzer et al. [K14]	<p><u>Cancer of extra-thoracic airways (n=234):</u> non-significant increase with radon exposure: ERR/100WLM=0.036, 95% CI: –0.009, 0.08</p> <p>No increase with LLR exposure: ERR per 100 kBq/m<sup>3</sup>= –0.17, 95% CI: –2.50, 2.16 (adjusted for radon exposure)</p>	Estimate of risk for uranium exposure had potential confounding by external radiation levels, arsenic and silica dust exposure and smoking habit. Quantitative risk estimate is relevant for uranium risk assessment: suggests little risk for extra-thoracic airways
Kreuzer et al. [K18]	Mortality in 4,054 male German uranium millers (1946–2008) who had never worked as uranium miners, so radon exposure was low, mean 8 WLM. Estimated exposure to radon, external gamma radiation, LLR and silica. Exposure estimates derived via a job exposure matrix of intensity (from ambient monitoring) by location, job, calendar year. Mean LLR: 3.9 kBq/m <sup>3</sup> . Preliminary organ dose calculations for alpha-emitting LLR averaged 3 mGy for lung, and 1 mGy for liver and red bone marrow	<p><u>All cancer:</u> LRR ERR per 100 kBq/m<sup>3</sup> = –0.43 (95% CI: –1.31, 0.44, n=457), adjusted for radon exposure</p> <p><u>Lung cancer:</u> LRR ERR=–0.61 (CI: –1.42, 1.9, n=159), (not adjusted for radon)</p> <p>Additional LLR risk coefficients given in text of table 16 (lympho-haematopoietic), table 17 (colon and rectal), table 18 (kidney and prostate), table 20 (circulatory)</p>	Well conducted study, suggesting little/no association of uranium exposure with various health outcomes. Study size was small and no smoking information available. Quantitative risk estimates are relevant for uranium risk assessment
Mohner et al. [M50]	Nested case-control study of leukaemia mortality (1953–1989) among ~360,000 German Wismut male uranium miners: 377 leukaemia deaths and 980 controls matched on age. Job exposure matrix JEM by location, job and year used to estimate red bone marrow (RBM) exposure. JEM for radon and decay products (RDP), external radiation and LLR exposure estimates for >500 different workplaces, 750 job titles, 44 calendar years. Mean cumulative RBM dose was 23.6 mGy; only 2% from inhalation of LLR	<p><u>Leukaemia:</u> non-chronic lymphocytic leukaemia (non-CLL) risk not associated with RDP, but showed suggestive association with LLR exposure. ERR per 100 kBq/m<sup>3</sup> for LLR was 1.04 (90% CI: –0.64, 2.73, n=377) for all leukaemia, 0.76 (CI: –1.26, 2.78, n=218) for non-CLL and 1.35 (CI: –1.54, 4.24, n=159) for CLL. Suggestion that the highest/longest LRR doses may increase risk: for ≥20 kBq/m<sup>3</sup>, (OR=1.26, 90% CI: 0.71, 2.22) for non-CLL. For acute myelogenous leukaemia, the LRR ERR per 100 kBq/m<sup>3</sup> was 0.83 (CI: –1.9, 3.6)</p>	Provides evidence that LLR exposure has little association with leukaemia risk. Limitations: prior to 1955 little data on exposure levels so dose uncertainties. Mortality may have been underascertained because inadequate identifiers in early years limited mortality linkage. Underlying cohort and numbers in it rather loosely defined, though it is the largest uranium worker cohort. Quantitative risk estimates are relevant for uranium risk assessment



<i>Study references</i>	<i>Summary of study</i>	<i>Summary of findings relating to uranium</i>	<i>Relevance for this report</i>
Mohner et al. [M51]	Nested case-control study of laryngeal cancer among ~360,000 German Wismut male uranium miners ever employed, 1950–1989. Tumour registry follow-up, 1961–1989. Two matched controls per case. Crude information on smoking habits available for many workers and anecdotal information on alcohol consumption from medical records. Included 554 laryngeal cancer cases and 929 controls	<u>Laryngeal cancer</u> : elevated risk in highest cumulative LLR exposure category ( $\geq 10$ kBqh/m <sup>3</sup> ), OR=1.63 (95% CI: 1.03, 2.59, n=56), adjusted for smoking and alcohol intake. For continuous LLR cumulative exposure: ERR=0.098 (CI: -0.11, 0.31) per 10 kBqh/m <sup>3</sup> , unadjusted, or ERR=0.156 (CI: -0.11, 0.41) adjusted for smoking and alcohol intake	The same limitations for this study as for Mohner et al. [M50]. Follow-up successful for only 72.8% of potential controls. Quantitative risk estimate for laryngeal cancer is relevant for uranium risk assessment
Rage et al. [R5]	5,086 uranium miners employed by CEA-COGEMA in France; followed up 1946–2007 (mean 32.8 years). Cohort included 3,377 miners first employed after 1955, for whom radon, LLR and external $\gamma$ -ray exposure was recorded. Assessment of LLR exposure based on ambient measurements 1959–1982 and individual measurements thereafter. Doses retrospectively reconstructed for the period 1956–1958 [R4]. Post-1955 workers had mean of 1.64 kBqh/m <sup>3</sup> of LLR (range 0.01–10.4)	Internal LLR dose-response analyses were conducted, doses lagged 5 years. LRR results expressed as ERR/kBqh/m <sup>3</sup> : All cancer, 0.022 (95% CI: -0.049, 0.12, n=315); Lung, 0.32 (0.09, 0.73, n=94); All cancers except lung, -0.065 (n.e. 0.019, n=221); Other LLR risk coefficients given in text of table 15 (respiratory), 19 (kidney), 20 (brain/CNS) and 21 (circulatory). In summary, only lung cancer showed a significant positive association with LLR exposure	LLR exposure related to various mortality end points. Limitations: LLR correlated with and a small percentage of total radiation exposure; smoking information unavailable; lung cancer analyses did not adjust for silica exposure. Quantitative risk estimates are relevant for uranium risk assessment
Richardson and Wing [R12]	Nested case-control study of lung cancer among 3,864 Y-12 (Oak Ridge, USA) workers hired 1947–1974. Y-12 was a nuclear material fabrication plant. Internal exposure primarily LLR from ambient uranium dust. Individual monitoring for external radiation exposure began in 1948 and became plant-wide in 1961. Urinalysis monitoring increased in coverage through the 1950s and in vivo monitoring begun in 1961. Mean external lung dose (10.1 mSv) was fourfold lower than mean cumulative internal dose (44.7 mSv). Other exposure: beryllium, solvents, machine oils, mercury, lead	Nested case-control analyses were conducted, with matched controls. Exposure lagged by 5 years <u>Lung cancer</u> : LLR dose-response negative (ERR per 100 mSv=-0.077, 90% CI: -0.23, 0.07) <u>Smoking-related diseases other than lung cancer</u> : LRR (ERR per 100 mSv=-0.089) was negative, as was non-malignant respiratory disease (-0.085), but with wide confidence intervals	Provides evidence that uranium risk for lung cancer is likely small. Strength: measured exposure (both urine assays and in vivo monitoring) and the fact that radon exposure did not overshadow the LLR exposure of the lung. LLR exposure had substantial uncertainties, in part because 58% of exposure person-years had imputed rather than measured doses. Limitations: dose uncertainties, inadequate information on smoking and workplace chemicals, statistical power limited. Quantitative risk estimate for lung cancer is relevant for uranium risk assessment

Study references	Summary of study	Summary of findings relating to uranium	Relevance for this report
Silver et al. [S19] (Prior reports: [D33, R14, R15])	Cohort of 6,409 uranium workers at Fernald (USA) employed (1951–1985), and followed through 2004 (mean follow-up 37 years). Used urine uranium concentration data (>250,000 urine samples) from 1952 forward to estimate exposure to internally deposited uranium compounds. Mean cumulative doses to the lung for hourly and salaried workers were 1,552 µGy and 388 µGy for LLR, respectively. Mean LLR cumulative organ dose ranged from 1.1 mGy (lung) to 6.7 mGy (pancreas)	Analyses took into account pay code, birth year, trichloroethylene exposure, radon and external radiation. Overall: hourly males showed excess lung cancer (SMR=1.25, 95% CI: 1.09, 1.42, n=297). LRR ERRs calculated for Caucasian males per organ-specific 100 µGy: <u>Intestinal cancer (small intestine and colon, not rectum)</u> : had a significant elevation in the highest dose group (>36 µGy, ERR=1.7, CI: 0.17, 5.7) and a significant dose response (ERR 100 per µGy=1.5, CI: 0.12, 4.1, n=48). Other dose-response estimates at 100 µGy for internal doses were null. Additional LLR risk coefficients given in text of table 15 (lung, respiratory), table 16 (leukaemia, lymphoma), table 17 (stomach, pancreas), table 18 (kidney)	This study has longer follow-up and better exposure assessment than previous ones. Uranium internal doses estimated for several different organs and linear ERR estimates adjusted for other radiation exposure. Sole positive finding related to intestinal cancer, which is not a very high a priori suspect, so requires confirmation. Limitations: no smoking data, limited data on exposure to chemicals and other hazardous substances, limited statistical power. Quantitative risk estimates are relevant for uranium risk assessment
Tomasek and Malatova [T13]	9,973 Czech uranium miners studied for leukaemia and non-Hodgkin's lymphoma risk. Two cohorts: S, 4,348 exposed 1948–1963; N, 5,625 exposed 1968–1986. Though had limited exposure measurements, derived location-job-year estimates of dose rates for hewers and then proportionately scaled for other jobs to develop a job exposure matrix JEM. Estimated 52–64% of the red bone marrow (RBM) dose was from LLR. Mean LLR RBM dose of 160 mSv for cohort S and 37 mSv for cohort N	<u>Leukaemia</u> : using 2 years dose lag, for 1–19 years since 1st exposure leukaemia SMR=1.0 (95% CI: 0.4, 2.1, n=7). For >19 years since 1st exposure SMR=1.8 (CI: 1.2, 2.7, n=23). For total follow-up period, SMR=1.5 (CI: 1.1, 2.2, n=30, mean RBM LLR dose 145 mSv). Due to small numbers, did not separate out non-CLL leukaemias. Leukaemia risk slope for total RBM dose (external, radon progeny and LLR), ERR per Sv=2.5 (90% CI: 0.3, 9.3) <u>Non-Hodgkin's lymphoma (NHL)</u> : dose response not significant (p=0.16), though a nominal overall excess (SMR=1.5, CI: 0.9, 2.2)	Dose uncertainties were probably large, especially for earlier years (that contributed the highest exposure) and the number of malignancies was small. Analyses of LLR exposure were by average SMRs and not dose responses. Study suggestive of leukaemia risk from uranium exposure, but study limitations weaken the conclusions
Vacquier et al. [V2]	French cohort of 3,377 uranium miners first employed 1955–1990 when exposure to external radiation, radon and uranium dust (LLR) could be estimated. 3,240 had internal exposure. Follow-up through 1999, a mean of 26.5 years; mean LLR exposure, 1,632 kBq/m <sup>3</sup> . LLR exposure estimates: reconstructed before 1959; ambient measurements 1959–1982; since 1983 personal film dosimeters. Since external radiation, LLR and radon exposure instances were correlated, determined which were associated with cancer risks	LLR exposure was correlated r=0.52 with cumulative radon exposure, 0.47 with external exposure. Combined cumulative radiation exposure showed significant dose response only for lung cancer. Linear ERR risk coefficients per (kBq.h.m <sup>-3</sup> ) for LLR exposure, lagged 5 years: All cancer: 0.001 (95% CI: -0.08, 0.11); Lung cancer: 0.25 (CI: 0.02, 0.70); Brain/CNS cancer: 0.17 (CI: n.e., 2.0)	LLR dose-responses could not be calculated with adjustment for radon or external exposure. Substantial correlation of LLR with radon and gamma exposure, so LLR risk estimates not well defined but suggestive small association with lung cancer. Limitations: uncertainties in exposure assessments, correlated exposure, lack of smoking data. Quantitative risk estimates are relevant for uranium risk assessment

<i>Study references</i>	<i>Summary of study</i>	<i>Summary of findings relating to uranium</i>	<i>Relevance for this report</i>
Yiin et al. [Y3]	Nested case-control study of multiple myeloma among 47,941 workers at the K-25 Oak Ridge, USA gaseous diffusion uranium enrichment plant (operated 1945–1985). Five matched controls per case. Exposure to soluble and insoluble uranium compounds. Individual uranium dose estimates based on ambient measurements and urinalysis. Formed groups according to the strength of the dosimetry: grouping I, multiple urinalyses and extensive ambient measurements; groupings II also included those with fewer measurements; grouping III, all cases and controls. External radiation doses and medical radiation exposure also compiled	<u>Multiple myeloma</u> : 98 multiple myeloma death cases and 490 controls. Analyses adjusted for birth cohort, external and medical irradiation, mercury, nickel and trichloroethylene exposure. For those with the best estimated uranium doses to the bone marrow (Group I), the odds ratio (OR) at 10 µGy was 1.04 (95% CI: 1.00, 1.09). For total case-control group (Group III), OR was identical: 1.04 (CI: 1.00, 1.09). Indicated a weak association of bone marrow dose from uranium with multiple myeloma risk	High quality study. Included detailed uranium exposure assessment and analyses adjusted for external and medical radiation doses and prevalent chemicals. Weak association found between uranium bone marrow dose and multiple myeloma risk; requires confirmation by other studies. Limitations: less measurement data were available for workers in the earlier days. Quantitative multiple myeloma risk estimate is relevant for uranium risk assessment
Zhivin et al. [Z10]	Studied 4,688 French gaseous diffusion uranium enrichment workers (AREVA NC, CEA and Eurodif) with exposure to mainly soluble uranium compounds (Type F). Used plant-specific job exposure matrices (JEMs) to estimate cumulative exposure. The AREVA NC job exposure matrices showed 64% sensitivity and 80% specificity in validation against bioassay data. Median follow-up, 30.2 years, 1968–2008. Had estimates of potential confounding exposure situations: trichloroethylene, heat, noise	From job exposure matrices, grouped workers into no, low, medium, high exposure for analysis. Analysed external radiation, and natural, enriched and DU. Analysed all cancer, lung cancer, lympho-haematopoietic malignancies, and circulatory diseases. Results by exposure group presented in text of table 15 (lung), table 16 (lympho-haematopoietic), table 20 (circulatory)	Study developed quantitative estimates of uranium exposure, but analysed only low, medium and high grouped uranium exposure. Valuable because it considered mainly highly soluble uranium and compared natural, enriched and depleted isotopic forms. Provides semi-quantitative information regarding uranium risk for CSD, including analyses of isotopic composition

Table A9. Studies of groups with potential military uranium exposure

Study references	Summary of study	Summary of findings related to uranium	Relevance for this report
Bogers et al. [B28]	Following lay-press reports of alleged excess leukaemia among Dutch Balkan veterans, study examined cancer incidence, comparing 18,175 Balkan-deployed military male personnel with 135,355 non-Balkan deployed military males and with general population rates. Maximum follow-up was for nearly 15 years. Some differences between the Balkan and non-Balkan cohorts' military status, e.g. conscripted soldiers (15% vs. 81%, respectively)	<p><u>All cancer:</u> total cancer incidence 17% lower among Balkan than non-Balkan personnel (hazard ratio (HR) 0.83, 95% CI: 0.69, 1.00)</p> <p><u>Miscellaneous cancers:</u> rates of digestive, respiratory, urogenital and haematological cancers non-significantly lower in the Balkan vs. non-Balkan group</p> <p><u>Leukaemia:</u> HR could not be calculated for leukaemia because of the small number of cases (Balkan n=5)</p>	No information about exposure to DU available, so study non-informative about uranium effects
Hines et al. [H18]	37 US Gulf War I veterans who had inhalation exposure to (and sometimes retained fragments of) DU from friendly fire incidents were examined. Compared those with high vs. low body burdens of DU, as measured by urine assay. DU remaining in the body is 40% less radioactive but chemically similar to natural uranium. Low and high exposure groups similar in age, race, BMI and smoking	<u>Non-malignant respiratory disease:</u> no differences between low and high exposure groups for any of a list of pulmonary symptoms or for history of steroid prescriptions. No significant differences regarding DU exposure levels in pulmonary function parameters or chest CT findings	Study strengths: had clinical examinations, spirometric testing, symptom reporting, and smoking information. DU findings do not indicate any non-malignant pulmonary effects. Provided limited information regarding uranium effects due to small sample size and likelihood that exposure levels were low
Labar et al. [L3]	Ecological study to examine childhood haematological cancers in Croatian counties with DU (10 counties), chemical plant damage (2 counties) or "population mixing" (4 counties). Compared disease rates for children ages 0–14 before (1986–1990), during (1991–1995) or after (1996–1999) the Croatian war in those counties	<u>Childhood haematological malignancies:</u> in the 10 counties with DU exposure, no significant increases during or after the War were found for lymphatic leukaemia, myeloid leukaemia, Hodgkin's lymphoma, or non-Hodgkin's lymphoma	No evidence for an effect of DU on childhood haematological malignancies. Exposure very low, and ecological data are susceptible to various unidentified biases, so study provides no meaningful information on uranium risk
Macfarlane et al. [M2]	A 13 year follow-up was conducted of 51,753 UK veterans deployed in the Gulf War and 50,808 other veterans matched for age-group, sex, rank, service and level of fitness, who were not deployed to the Gulf. 57% responded to a questionnaire about deployment experiences and morbidity	7% of those with questionnaires responded they had received DU exposure, among whom there were 9 disease-related deaths. The DU exposed vs. unexposed yielded a RR=1.00 (95% CI: 0.99, 4.04) after adjustment for age, sex, smoking and alcohol intake	DU exposure was based on unverified self-reports and the risk estimate was for overall disease deaths, not a priori causes. The small number of deaths (n=9) among those reportedly exposed to DU is a very weak finding
McDiarmid et al. [M22]	US Gulf War veterans with DU exposure were followed up (1991–2005) for clinical and laboratory end points. On basis of repeated urine uranium measurements, 10 were designated as high DU exposure and 24 as low exposure. Exposure resulted from inhalation, wound contamination and/or embedded fragments (for ~30%)	The extensive clinical examination did not show any differences between the high and low exposed group. Other high/low exposure comparisons: no difference in urine retinol binding protein, a biomarker of renal proximal tubule function. No differences found on: other renal measures, a neurocognitive test battery, neuroendocrine parameters, semen parameters, or HPRT mutations. A borderline increase in chromosome aberrations in the high exposure group	Among the several dozen parameters measured, only chromosome aberrations showed a (suggestive) difference. The multiple comparisons and small sample size limited the statistical power and meaningfulness of the comparisons

<i>Study references</i>	<i>Summary of study</i>	<i>Summary of findings related to uranium</i>	<i>Relevance for this report</i>
McDiarmid et al. [M23]	35 US Gulf War veterans with DU exposure in 1991 were again evaluated in 2007 with numerous clinical and laboratory measures	Only two parameters showed marginal differences between the high- and low exposure groups: $\beta_2$ microglobulin (81.7 vs. 69 $\mu\text{g/g}$ creatinine, respectively; $p=0.11$ ) and retinol binding protein (48.1 vs. 31 $\mu\text{g/g}$ creatinine; $p=0.07$ ). No differences were seen in rates of chromosome aberrations or HPRT mutations	Among the several dozen parameters measured, only two showed a suggestive difference. The multiple comparisons and small sample size limited the statistical power and meaningfulness of the comparisons
McDiarmid et al. [M25]	37 US Gulf War veterans with DU exposure in 1991 were again evaluated 20 years after exposure (2011) for numerous clinical and laboratory end points. Report focused on acute renal toxicity and included three new sensitive markers of kidney tubular injury	No differences between high- and low-exposure groups for: haematology, clinical chemistries, neuroendocrine parameters, bone metabolism, neurocognitive function, immune function, pulmonary function or nodules. Regarding renal function and injury, no high vs. low exposure differences were found for 16 clinical indicators of renal function, 6 urine markers for kidney injury, or 4 urine measures of low molecular weight proteins, although a re-analysis using a different definition of high exposure showed elevations in two kidney injury markers	Two sensitive markers of kidney tubular injury suggested subtle renal injury, but this found only after the main categories of high vs. low exposure showed no differences. Multiple comparisons and small sample size limit the inferences that can be drawn from the study
Strand et al. [S42]	Cancer risk and all cause mortality studied among 6,076 Norwegian military UN peacekeepers in Kosovo, 1999–2011. No information available on DU exposure. Mean follow-up, 10.2 years; 4.4% women	69 cancer cases observed (SIR=1.04, 95% CI: 0.81, 1.33). Suggestion of elevation in melanoma (SIR=1.90, CI: 0.95, 3.4, $n=11$ ). No elevation in stomach, liver, lung, prostate, kidney, bladder, brain cancers or lympho-haematopoietic malignancies	With no data on DU exposure, study is uninformative regarding uranium risk

Table A10. Studies of general population groups with potential environmental exposure to uranium by inhalation

Study references	Summary of study	Summary of findings related to uranium	Relevance for this report
Boice et al. [B31]	Study evaluated cancer incidence (1993–1997) among residents near Apollo (began operations 1957) and Parks uranium-plutonium processing plants in Pennsylvania, USA. Study population included about 17,000 individuals in 8 nearby municipalities	<p><u>All cancer:</u> found 581 incident cancers when 574 were expected (SIR=1.01, 95% CI: 0.93, 1.10)</p> <p><u>A priori tumour sites:</u> for tumour sites with potentially greater exposure they found: lung (SIR=0.88), kidney (SIR=1.05), non-Hodgkin's lymphoma (SIR=1.10), liver (SIR=0.61) and bone (2 observed, 1.19 expected), none of which were statistically significant elevations. Also thyroid and female breast cancer rates were not elevated, nor was leukaemia</p>	Earlier investigation had obtained soil measurements of uranium, plutonium and other isotopes and air measurements of gamma radiation; all levels well below Nuclear Regulatory Commission release guidances. Those measurements too sparse to be used to directly assess uranium effects associated with exposure of individuals. Limited environmental measurements and negligibly low exposure levels mean study is not informative as to uranium effects
Boice et al. [B30]	People in two counties proximal to the Apollo and Parks, Pennsylvania, USA former uranium/plutonium material processing plants were concerned regarding possible elevated rates of cancer, especially childhood leukaemia. Study compared cancer mortality rates in those two counties (population ~443,000) with six other counties (population ~864,000) matched on age, race, urbanization and socioeconomic factors. Comparisons made before, during and after operations of the uranium-plutonium plants	<p><u>All cancer:</u> during 1950–1995, 39,287 cancer deaths occurred in the proximal counties and 77,382 in the control counties. Compared to control counties, RRs in proximal counties for all cancer deaths before (1950–1965), during (1965–1980) and after (1980–1995) were virtually identical—0.95, 0.95 and 0.98, respectively—indicating no effect of potential uranium/plutonium exposure</p> <p><u>A priori tumour sites:</u> for childhood leukaemia (total n=119 proximal county cases and n=272 control cases) before, during, after RRs=1.02, 0.81, 0.57, respectively. Lung cancer (RR=0.85, 0.99, 0.95), bone (RR=0.96, 1.00, 1.01), liver (RR=0.98, 1.07, 1.01) and kidney (RR=1.00, 1.08, 1.02) not significantly elevated in the proximal counties</p>	<p>Strengths: the mortality ascertainment was high, sample size was large. Most likely uranium-related cancer types examined</p> <p>Weaknesses: no individual or even county-level estimates of uranium exposure levels. Proximal county areas were rather broad, further diluting possible exposure, though nearly all inhabitants lived within 20 miles of a processing plant</p> <p>Conclusion: because of low exposure levels and ecological nature of the study, does not adequately address the health risks of uranium</p>
Boice et al. [B32]	Cancer mortality rates investigated in Karnes County, Texas, USA, a county with uranium mining and milling activities from 1959 to early 1990s, with 3 mills and >40 mines. No uranium enrichment activities. Karnes cancer mortality rates before, during, after that period (1950–2001) compared with four match control counties. 1,223 cancer deaths observed in Karnes County (1,392 expected) and 3,857 in control counties. Texas Department of Health monitored Karnes radiation levels, found no elevations in radioactive material in/near homes	<p><u>All cancer:</u> Karnes County RRs of 1.0 in 1950–1964 (before/beginning of mining-milling), 0.9 in 1965–1979 (early operations), 1.1 in 1980–1989 (later operations and latency period) and 1.0 in 1990–2001 (few/no operations)</p> <p><u>A priori tumour sites:</u> for prime exposure periods (1965–1979 and 1980–1989), Karnes county RRs were 1.0, 1.2, respectively, for lung cancer, 0.8, 0.9 for kidney cancer, 1.0, 0.8 for liver cancer, and 1.3 (n=20) and 1.7 (n=17) for leukaemia. no RRs significantly elevated. Childhood cancer mortality 1965–2001, non-significant RR of 1.3 (n=8 cases)</p>	<p>Strengths: mortality ascertainment was high. A priori cancer types specifically examined</p> <p>Weaknesses: limited uranium exposure measurements available to use in analysis. Cancer mortality misdiagnoses, especially for liver cancer</p> <p>Relevance: because of low, unknown exposure levels and ecological nature of the study, does not adequately address the health risks of uranium</p>

<i>Study references</i>	<i>Summary of study</i>	<i>Summary of findings related to uranium</i>	<i>Relevance for this report</i>
Boice et al. [B34]	Mortality evaluated during 1978–2004 for 1936–1984 residents of Uravan, Colorado USA, a uranium mill town. Mining and milling activities during mid-1930s to 1984. The mean follow-up time since first Uravan residence, 38.1 years	<u>All cancer</u> : no significant elevation in overall cancer mortality or cancers of lung, kidney, breast; leukaemia; non-malignant respiratory, renal or liver disease among females or the 622 uranium mill workers, but excess lung cancer found among underground uranium miners. Had no quantitative information on exposure levels of mill workers	Study uninformative regarding uranium effects because no uranium exposure data and has low statistical power
Boice et al. [B35]	Comparison of 1950–2000 mortality in Montrose County, Colorado, USA (Uravan and other mining/milling operations) with five comparison counties	<u>All cancer</u> : no difference in total cancer <u>A priori tumour sites</u> : montrose elevation of lung cancer in males (RR=1.19, 95% CI: 1.06, 1.33), thought to be due to underground miner radon exposure and heavy smoking. No excess of breast, kidney, bone, liver or childhood cancer, leukaemia, non-Hodgkin's lymphoma, renal disease or non-malignant respiratory disease	Since no information on who was exposed to uranium and exposure levels, study uninformative regarding uranium risk
Boice et al. [B37]	Cancer incidence (1982–2004) and mortality (1950–2004) in Grants, New Mexico, USA residents: Grants mining during early 1950s to 1990; milling operations 1958–1990	<u>Lung cancer</u> : found increased mortality from lung cancer among men (SMR=1.57, 95% CI: 1.21, 1.99) <u>Stomach cancer</u> : stomach cancer mortality among women was high (SMR=1.30, 95% CI: 1.03, 1.63), but elevated mainly in the early years before milling operations began	Lung cancer excess was likely due to miner radon exposure and smoking. Uranium exposed individuals not identified, so it is uninformative
Chen et al. [C24]	Ecological study of cancer incidence in Port Hope, Ontario, Canada residents, 1992–2007. In 1981–1982, air uranium concentrations averaged 0.02 µg m <sup>-3</sup> leading to a committed effective dose of 0.16 mSv, but by 1988–1989 were reduced to 0.00105 µg m <sup>-3</sup> . Larger doses received from gamma and radon exposure. Population ~16,500	Standardized incidence ratio (SIR) for leukaemia, 0.86 (95% CI: 0.60, 1.21), with no elevation of childhood leukaemia rate SIRs were <1.0 for a number of other cancer sites. A significant elevation of lung cancer incidence, perhaps related to smoking habits	Provides some information on average air uranium levels, but analyses were ecological and not specific for uranium exposure. Study useful insofar as it rules out large uranium effects
Report of the Consejo de Seguridad Nuclear [C37]	Ecological study of cancer mortality in municipalities near seven nuclear power plants and five fuel cycle facilities (chemical conversion of uranium concentrate) in Spain. Cancer mortality (1975–2003) of municipalities within 30 km of facilities compared to similar municipalities 50–100 km distant	With reconstructed external doses, reported increasing dose-response trends for kidney cancer around nuclear power plants and for lung and bone cancers around fuel cycle facilities, but had not estimates of uranium exposure	Report is uninformative regarding uranium exposure effects, as it is an ecological study and only estimated external radiation exposure
Lopez-Abente et al. [L46]	Examined solid cancer mortality (1975–1993) in 283 towns in Spain within 30 km of one of four nuclear power plants or four nuclear fuel facilities, compared to 275 towns 50–100 km away, matched on various sociodemographic variables	They concluded that lung cancer and kidney cancer mortality rates were higher in the 30 km area, but other types of cancer were not	Various inconsistencies in the results depending on how the analyses were performed. They chose analyses that showed positive effects. No information presented on uranium exposure levels, so study is uninformative regarding uranium risk

<i>Study references</i>	<i>Summary of study</i>	<i>Summary of findings related to uranium</i>	<i>Relevance for this report</i>
Lopez-Abente et al. [L45]	Examined lympho-haematopoietic malignancies (LHMs) in 489 towns within 30 km of Spain's seven nuclear power plants and five nuclear fuel facilities ("exposed"), compared to 477 towns 50–100 km away ("unexposed"). Exposed towns reported 610 leukaemias, 198 lymphomas and 122 multiple myeloma deaths during 1975–1993	No excess LHM found in towns near nuclear power plants. Reported excess leukaemia mortality near two nuclear fuel facilities and excess myeloma mortality near one nuclear fuel facility. No exposed town showed excess leukaemia for the under age 25 group. Analyses of all nuclear fuel facilities combined did not yield statistically significant excess for any end point (leukaemia, leukaemia <25 years, myeloma, Hodgkin's lymphoma, non-Hodgkin's lymphoma)	Selecting a few "significant" results from a large number of statistical tests is questionable. The results for all nuclear fuel facilities combined, or all nuclear power plants, do not indicate elevated risks for lympho-haematological malignancies
Pinney et al. [P22]	Examined prevalence ratios of diseases among 8,496 residing within 2 miles (3.2 km) from Fernald, USA uranium plant, or within 5 miles (8 km) and in groundwater runoff direction, or with well/cistern. Medical conditions obtained by questionnaire and screening examination. Prevalences were compared to NHIS/NHANES data (national standardized surveys)	Reported a number of elevated prevalences of kidney and bladder diseases/conditions compared to NHIS data, but screening questions or coding sometimes differed between the two datasets. Found no differences for diabetes, thyroid diseases or respiratory diseases. Several clinical laboratory variables showed small but significant differences between those within 2 miles or more distant, and a different set of variables were significant for those using wells/cisterns	Distance from the plant and/or possible exposure to plant runoff used as surrogates for uranium doses. Actual measured exposure levels very low. Since perceived residential risks from Fernald were current in the population, results based on self reports may have been biased. Inconsistencies among comparisons of laboratory findings create uncertainty in the interpretation

Table A11. Summary of literature review on health effects of human exposure to uranium through ingestion of surface or groundwater

<i>Study</i>	<i>Study design</i>	<i>Country</i>	<i>Effect</i>	<i>Effect measurement</i>	<i>Relevance for this report</i>
Mao et al. [M9]	Cross-sectional	Canada	Chemical toxicity of urinary system	Comparison of biomarker levels in urine (microalbuminuria) and serum (creatinine)	Positive association between uranium cumulative exposure index and albumin level
Zamora et al. [Z6]	Cross-sectional	Canada	Chemical toxicity of urinary system	Comparison of biomarker (glucose, creatinine, protein, beta2-microglobulin, alkaline phosphatase, $\gamma$ -glutamyl transferase, lactate dehydrogenase, N-acetyl- $\beta$ -D-glucosaminidase) levels	Alkaline phosphatase, beta2-microglobulin levels correlated with uranium level in water
Kurttio et al. [K26]	Cross-sectional	Finland	Chemical toxicity of urinary system	Comparison of biomarker (calcium, phosphate, glucose, albumin, creatinine, beta2-microglobulin) levels	Significantly increased calcium, fractional excretion No association between uranium exposure and other parameters
Kurttio et al. [K28]	Cross-sectional	Finland	Chemical toxicity of urinary system	Comparison of renal damage indicators (glucose, creatinine, alkaline phosphatase, $\gamma$ -glutamyl transferase, lactate dehydrogenase, N-acetyl- $\beta$ -D-glucosaminidase, calcium, phosphate, cystatin C, glutathione-S-transferase) in urine	No statistically significant association between uranium concentrations in urine and any of the renal damage indicators, except glucose excretion in urine and diastolic blood pressure



<i>Study</i>	<i>Study design</i>	<i>Country</i>	<i>Effect</i>	<i>Effect measurement</i>	<i>Relevance for this report</i>
Selden et al. [S8]	Cross-sectional	Sweden	Chemical toxicity of urinary system	Comparison of biomarker (albumin, beta2-microglobulin, protein HC, kappa and lambda chains, N-acetyl-β-D-glucosaminidase) levels in urine	Significant increase in urinary excretion of β-2 microglobuline, kappa and lambda chains, and HC protein with medium to high uranium concentrations in urine. Dose–response relationships observed after exclusion of subjects with diabetes
Kurttio et al. [K29]	Case-cohort	Finland	Urinary system as target of radio-toxicity	Comparison of risk of bladder cancer by uranium level and radiation dose	No excess of bladder cancer with increased level of uranium or radiation dose
Kurttio et al. [K27]	Cross-sectional	Finland	Bone as target of chemical toxicity	Correlation between uranium exposure and biomarkers associated with bone (osteocalcin, aminoterminal propeptide of type I procollagen, serum type I collagen carboxy-terminal telopeptide)	Marginal positive association of uranium concentrations in drinking water with serum type I collagen and carboxy-terminal telopeptide only in men (p=0.05) No significant association between uranium exposure and bone turnover indicators in women
Seiler [S7]	Ecological	USA	Lympho-haematopoietic system	Comparison of uranium concentration in wells used by case families and other wells	No significant difference between uranium concentrations in wells used by families of leukaemia cases (median=3.4 µg/L) and the uranium concentrations in other wells (1.6 µg/L) No differences in concentrations of gross α activity or of Rn (617 vs. 563 pCi/L)
Auvinen et al. [A32]	Case-cohort	Finland	Lympho-haematopoietic system	Comparison of risk of leukaemia according to uranium level	No excess of leukaemia according to uranium level of drinking water
Witmans et al. [W23]	Case-control	Canada	Lympho-haematopoietic system	Comparison of U <sub>w</sub> and Th <sub>w</sub> exposure between cases and controls	Cases had higher uranium concentrations in drinking water than controls (p=0.001) No significance difference in Th <sub>w</sub> (p=0.22)
Auvinen et al. [A32]	Case-cohort	Finland	Digestive system	Stomach cancer risk according to uranium level	No excess of stomach cancer by uranium level



## REFERENCES

- A1 Abou-Donia, M.B., A.M. Dechkovskaia, L.B. Goldstein et al. Uranyl acetate-induced sensorimotor deficit and increased nitric oxide generation in the central nervous system in rats. *Pharmacol Biochem Behav* 72(4): 881-890 (2002).
- A2 Adams, N. and N.L. Spoor. Kidney and bone retention functions in the human metabolism of uranium. *Phys Med Biol* 19(4): 460-471 (1974).
- A3 Al-Hadithi, T.S., J.K. Al-Diwan, A.M. Saleh et al. Birth defects in Iraq and the plausibility of environmental exposure: A review. *Confl Health* 6(1): 3 (2012).
- A4 Al-Hashimi, M.M. and X. Wang. Comparing the cancer in Ninawa during three periods (1980-1990, 1991-2000, 2001-2010) using Poisson regression. *J Res Med Sci* 18(12): 1026-39 (2013).
- A5 Al-Masri, M.S., A. Al-Hamwi, Y. Amin et al. Radionuclide transfer from feed to camel milk. *J Environ Radioact* 132: 8-14 (2014).
- A6 Alaani, S., M. Tafash, C. Busby et al. Uranium and other contaminants in hair from the parents of children with congenital anomalies in Fallujah, Iraq. *Confl Health* 5: 15 (2011).
- A7 Alaani, S., M.A. Al-Fallouji, C. Busby et al. Pilot study of congenital anomaly rates at birth in Fallujah, Iraq, 2010. *J IMA* 44(1): 1-7 (2012).
- A8 Albertini, R.J., P.M. Vacek, E.W. Carter et al. Mutagenicity monitoring following battlefield exposures: Longitudinal study of HPRT mutations in Gulf War I veterans exposed to depleted uranium. *Environ Mol Mutagen* 56(7): 581-593 (2015).
- A9 Albina, M.L., M. Belles, M. Gomez et al. Influence of maternal stress on uranium-induced developmental toxicity in rats. *Exp Biol Med (Maywood)* 228(9): 1072-1077 (2003).
- A10 Albina, M.L., M. Belles, V. Linares et al. Restraint stress does not enhance the uranium-induced developmental and behavioral effects in the offspring of uranium-exposed male rats. *Toxicology* 215(1-2): 69-79 (2005).
- A11 Alrefae, T. Investigation of <sup>238</sup>U content in bottled water consumed in Kuwait and estimates of annual effective doses. *Health Phys* 102(1): 85-89 (2012).
- A12 Anderson, J.L., H.B. Spitz and J.H. Yiin. Characterization of internal exposure to enriched uranium at a former gaseous diffusion plant. *Health Phys* 93(6): 636-644 (2007).
- A13 Angenard, G., V. Muczynski, H. Coffigny et al. In vitro effects of uranium on human fetal germ cells. *Reprod Toxicol* 31(4): 470-476 (2011).
- A14 Anke, M., O. Seeber, R. Müller et al. Uranium transfer in the food chain from soil to plants, animals and man. *Chemie der Erde - Geochemistry* 69(Suppl 2): 75-90 (2009).
- A15 Ansoborlo, E., V. Chazel, M.H. Henge-Napoli et al. Determination of the physical and chemical properties, biokinetics, and dose coefficients of uranium compounds handled during nuclear fuel fabrication in France. *Health Phys* 82(3): 279-289 (2002).
- A16 Ansoborlo, E., O. Prat, P. Moisy et al. Actinide speciation in relation to biological processes. *Biochimie* 88(11): 1605-1618 (2006).

- A17 Ansoborlo, E., L. Lebaron-Jacobs and O. Prat. Uranium in drinking-water: A unique case of guideline value increases and discrepancies between chemical and radiochemical guidelines. *Environ Int* 77: 1-4 (2015).
- A18 Anthony, M.L., K.P. Gartland, C.R. Beddell et al. Studies of the biochemical toxicology of uranyl nitrate in the rat. *Arch Toxicol* 68(1): 43-53 (1994).
- A19 Arfsten, D.P., K.R. Still and G.D. Ritchie. A review of the effects of uranium and depleted uranium exposure on reproduction and fetal development. *Toxicol Ind Health* 17(5-10): 180-191 (2001).
- A20 Arfsten, D.P., K.R. Still, E.R. Wilfong et al. Two-generation reproductive toxicity study of implanted depleted uranium (DU) in CD rats. *J Toxicol Environ Health A* 72(6): 410-427 (2009).
- A21 Arnault, E., M. Doussau, A. Pesty et al. Natural uranium disturbs mouse folliculogenesis in vivo and oocyte meiosis in vitro. *Toxicology* 247(2-3): 80-87 (2008).
- A22 Arogunjo, A.M., V. Hollriegl, A. Giussani et al. Uranium and thorium in soils, mineral sands, water and food samples in a tin mining area in Nigeria with elevated activity. *J Environ Radioact* 100(3): 232-240 (2009).
- A23 Arruda-Neto, J.D., M.V. Guevara, G.P. Nogueira et al. Long-term accumulation of uranium in bones of Wistar rats as a function of intake dosages. *Radiat Prot Dosim* 112(3): 385-393 (2004).
- A24 Arruda-Neto, J.D., M.V. Manso Guevara, G.P. Nogueira et al. Long-term accumulation and microdistribution of uranium in the bone and marrow of beagle dog. *Int J Radiat Biol* 80(8): 567-575 (2004).
- A25 Arzuaga, X., S.H. Rieth, A. Bathija et al. Renal effects of exposure to natural and depleted uranium: A review of the epidemiologic and experimental data. *J Toxicol Environ Health - Part B: Critical Reviews* 13(7-8): 527-545 (2010).
- A26 Arzuaga, X., M. Gehlhaus and J. Strong. Modes of action associated with uranium induced adverse effects in bone function and development. *Toxicol Lett* 236(2): 123-130 (2015).
- A27 ASN, DGS and IRSN. La qualité radiologique des eaux conditionnées produites en France. Autorité de sûreté nucléaire, Direction générale de la santé, Institut de Radioprotection et de Sûreté Nucléaire, France, 2013. (French).
- A28 Atkinson, W., R. Bull, M. Marshall et al. The association between prostate cancer and exposure to 65-Zn in UKAEA employees. *J Radiol Prot* 14(2): 109-114 (1994).
- A29 Atkinson, W.D., D.V. Law, K.J. Bromley et al. Mortality of employees of the United Kingdom Atomic Energy Authority, 1946-97. *Occup Environ Med* 61(7): 577-585 (2004).
- A30 Atkinson, W.D., D.V. Law and K.J. Bromley. A decline in mortality from prostate cancer in the UK Atomic Energy Authority workforce. *J Radiol Prot* 27(4): 437-445 (2007).
- A31 ATSDR. Toxicological profile for uranium. Agency for Toxic Substances and Disease Registry, Atlanta, Georgia, 2013.
- A32 Auvinen, A., P. Kurtio, J. Pekkanen et al. Uranium and other natural radionuclides in drinking water and risk of leukemia: a case-cohort study in Finland. *Cancer Causes Control* 13(9): 825-829 (2002).
- A33 Avasthi, P.S., A.P. Evan and D. Hay. Glomerular endothelial cells in uranyl nitrate-induced acute renal failure in rats. *J Clin Invest* 65(1): 121-127 (1980).
- A34 Avtandilashvili, M., M. Puncher, S.L. McComish et al. US Transuranium and Uranium Registries case study on accidental exposure to uranium hexafluoride. *J Radiol Prot* 35(1): 129-151 (2015).

- B1 Bagatti, D., M.C. Cantone, A. Giussani et al. Regional dependence of urinary uranium baseline levels in non-exposed subjects with particular reference to volunteers from Northern Italy. *J Environ Radioact* 65(3): 357-364 (2003).
- B2 Bakhmutsky, M.V., M.S. Oliver, M.A. McDiarmid et al. Long term depleted uranium exposure in Gulf War I veterans does not cause elevated numbers of micronuclei in peripheral blood lymphocytes. *Mutat Res* 720(1-2): 53-57 (2011).
- B3 Bal, W., A.M. Protas and K.S. Kasprzak. Genotoxicity of metal ions: chemical insights. *Met Ions Life Sci* 8: 319-373 (2011).
- B4 Ballou, J.E., R.A. Gies, A.C. Case et al. Deposition and early disposition of inhaled  $^{233}\text{UO}_2(\text{NO}_3)_2$  and  $^{232}\text{UO}_2(\text{NO}_3)_2$  in the rat. *Health Phys* 51(6): 755-771 (1986).
- B5 Banday, A.A., S. Priyamvada, N. Farooq et al. Effect of uranyl nitrate on enzymes of carbohydrate metabolism and brush border membrane in different kidney tissues. *Food Chem Toxicol* 46(6): 2080-2088 (2008).
- B6 Barber, D.S., M.F. Ehrich and B.S. Jortner. The effect of stress on the temporal and regional distribution of uranium in rat brain after acute uranyl acetate exposure. *J Toxicol Environ Health A* 68(2): 99-111 (2005).
- B7 Basset, C., O. Averseng, P.J. Ferron et al. Revision of the biodistribution of uranyl in serum: Is fetuin-A the major protein target? *Chem Res Toxicol* 26(5): 645-653 (2013).
- B8 Batchelor, A.L., T.J. Jenner and D.G. Papworth. Influence of macrophages on microdistribution of inhaled  $\text{UO}_2$  aerosol in rat lung. *Phys Med Biol* 27(7): 949-957 (1982).
- B9 Baysson, H., D. Laurier, M. Tirmarche et al. Epidemiological response to a suspected excess of cancer among a group of workers exposed to multiple radiological and chemical hazards. *Occup Environ Med* 57(3): 188-194 (2000).
- B10 Beckova, V. and I. Malatova. Dissolution behaviour of  $^{238}\text{U}$ ,  $^{234}\text{U}$  and  $^{230}\text{Th}$  deposited on filters from personal dosimeters. *Radiat Prot Dosim* 129(4): 469-472 (2008).
- B11 Belles, M., M.L. Albina, V. Linares et al. Combined action of uranium and stress in the rat. I. Behavioral effects. *Toxicol Lett* 158(3): 176-185 (2005).
- B12 Belles, M., V. Linares, G. Perello et al. Human dietary exposure to uranium in Catalonia, Spain. *Biol Trace Elem Res* 152(1): 1-8 (2013).
- B13 Benedik, L. and Z. Jeran. Radiological of natural and mineral drinking waters in Slovenia. *Radiat Prot Dosim* 151(2): 306-313 (2012).
- B14 Bensoussan, H., L. Grancolas, B. Dhieux-Lestaevel et al. Heavy metal uranium affects the brain cholinergic system in rat following sub-chronic and chronic exposure. *Toxicology* 261(1-2): 59-67 (2009).
- B15 Bensoussan, H., G. Resve, C.M. Vacher et al. Memory and cholinergic system impaired by sub-chronic exposure to uranium in young rats. *Toxicol Lett* 189: 226-227 (2009).
- B16 Bentley, K.W., J.H. Wyatt, D.J. Wilson et al. Uranium and plutonium in hair as an indicator of body burden in mice of different age and sex. *Bull Environ Contam Toxicol* 28(6): 691-696 (1982).
- B17 Bentley, K.W., D.R. Stockwell, K.A. Britt et al. Transient proteinuria and aminoaciduria in rodents following uranium intoxication. *Bull Environ Contam Toxicol* 34(3): 407-416 (1985).
- B18 Beral, V., P. Fraser, L. Carpenter et al. Mortality of employees of the Atomic Weapons Establishment, 1951-82. *Br Med J* 297(6651): 757-770 (1988).
- B19 Berradi, H., J.M. Bertho, N. Dudoignon et al. Renal anemia induced by chronic ingestion of depleted uranium in rats. *Toxicol Sci* 103(2): 397-408 (2008).

- B20 Berry, J.P., L. Zhang, P. Galle et al. Role of alveolar macrophage lysosomes in metal detoxification. *Microsc Res Tech* 36(4): 313-323 (1997).
- B21 Betcher, R.N., M. Gascoyne and D. Brown. Uranium in groundwaters of southeastern Manitoba, Canada. *Can J Earth Sci* 25(12): 2089-2103 (1988).
- B22 Betti, M. Civil use of depleted uranium. *J Environ Radioact* 64(2-3): 113-119 (2003).
- B23 Beyermann, M., T. Bünger, K. Schmidt et al. Occurrence of natural radioactivity in public water supplies in Germany:  $^{238}\text{U}$ ,  $^{234}\text{U}$ ,  $^{235}\text{U}$ ,  $^{228}\text{Ra}$ ,  $^{226}\text{Ra}$ ,  $^{222}\text{Rn}$ ,  $^{210}\text{Pb}$ ,  $^{210}\text{Po}$  and gross  $\alpha$  activity concentrations. *Radiat Prot Dosim* 141(1): 72-81 (2010).
- B24 Birke, M., U. Rauch, H. Lorenz et al. Distribution of uranium in German bottled and tap water. *J Geochem Explor* 107(3): 272-282 (2010).
- B25 Blantz, R.C. The mechanism of acute renal failure after uranyl nitrate. *J Clin Invest* 55(3): 621-35 (1975).
- B26 Bleise, A., P.R. Danesi and W. Burkart. Properties, use and health effects of depleted uranium (DU): a general overview. *J Environ Radioact* 64(2-3): 93-112 (2003).
- B27 BMJ. Verordnung über die Qualität von Wasser für den menschlichen Gebrauch (Trinkwasserverordnung - TrinkwV 2001). Bundesministeriums der Justiz und fuer Verbraucherschutz. [Internet] Available from ([http://www.gesetze-im-internet.de/bundesrecht/trinkwv\\_2001/gesamt.pdf](http://www.gesetze-im-internet.de/bundesrecht/trinkwv_2001/gesamt.pdf)) on 11.11.2013. (German).
- B28 Bogers, R.P., F.E. van Leeuwen, L. Grievink et al. Cancer incidence in Dutch Balkan veterans. *Cancer Epidemiol* 37(5): 550-555 (2013).
- B29 Boice, J.D., S.S. Cohen, M.T. Mumma et al. Mortality among radiation workers at Rocketdyne (Atomics International), 1948-1999. *Radiat Res* 166(1 Pt 1): 98-115 (2006).
- B30 Boice, J.D., Jr., W.L. Bigbee, M.T. Mumma et al. Cancer mortality in counties near two former nuclear materials processing facilities in Pennsylvania, 1950-1995. *Health Phys* 85(6): 691-700 (2003).
- B31 Boice, J.D., Jr., W.L. Bigbee, M.T. Mumma et al. Cancer incidence in municipalities near two former nuclear materials processing facilities in Pennsylvania. *Health Phys* 85(6): 678-90 (2003).
- B32 Boice, J.D., Jr., M. Mumma, S. Schweitzer et al. Cancer mortality in a Texas county with prior uranium mining and milling activities, 1950-2001. *J Radiol Prot* 23(3): 247-262 (2003).
- B33 Boice, J.D., Jr., R.W. Leggett, E.D. Ellis et al. A comprehensive dose reconstruction methodology for former rocketdyne/atoms international radiation workers. *Health Phys* 90(5): 409-30 (2006).
- B34 Boice, J.D., Jr., S.S. Cohen, M.T. Mumma et al. Mortality among residents of Uravan, Colorado who lived near a uranium mill, 1936-84. *J Radiol Prot* 27(3): 299-319 (2007).
- B35 Boice, J.D., Jr., M.T. Mumma and W.J. Blot. Cancer and noncancer mortality in populations living near uranium and vanadium mining and milling operations in Montrose County, Colorado, 1950-2000. *Radiat Res* 167(6): 711-726 (2007).
- B36 Boice, J.D., Jr., S.S. Cohen, M.T. Mumma et al. A cohort study of uranium millers and miners of Grants, New Mexico, 1979-2005. *J Radiol Prot* 28(3): 303-325 (2008).
- B37 Boice, J.D., Jr., M.T. Mumma and W.J. Blot. Cancer incidence and mortality in populations living near uranium milling and mining operations in Grants, New Mexico, 1950-2004. *Radiat Res* 174(5): 624-636 (2010).
- B38 Boice, J.D., Jr., S.S. Cohen, M.T. Mumma et al. Updated mortality analysis of radiation workers at Rocketdyne (Atomics International), 1948-2008. *Radiat Res* 176(2): 244-258 (2011).

- B39 Bolch, W.E., K.F. Eckerman, G. Sgouros et al. MIRD pamphlet No. 21: a generalized schema for radiopharmaceutical dosimetry--standardization of nomenclature. *J Nucl Med* 50(3): 477-84 (2009).
- B40 Bomben, A.M., H.E. Equillor and A.A. Oliveira.  $^{226}\text{Ra}$  and natural uranium in Argentinian bottled mineral waters. *Radiat Prot Dosim* 67(3): 221-224 (1996).
- B41 Bomben, A.M. and M.A. Palacios. Natural radionuclides in drinking water in Argentina. pp.P-1a-4 in: IRPA-10: International Congress of the International Radiation Protection Association, Hiroshima, Japan, 14-19 May 2000. IRPA, Hiroshima, 2000.
- B42 Bonin, B. and P.-L. Blanc. L'uranium dans le milieu naturel, des origines jusqu'à la mine. pp.7-41 in: L'uranium, de l'environnement à l'homme (H. Métivier, ed.) EDP Sciences, IRSN, Les Ulis, France, 2001.
- B43 Bonotto, D.M. and T.O. Bueno. The natural radioactivity in Guarani aquifer groundwater, Brazil. *Appl Radiat Isot* 66(10): 1507-1522 (2008).
- B44 Bosque, M.A., J.L. Domingo, J.M. Llobet et al. Embryotoxicity and teratogenicity of uranium in mice following subcutaneous administration of uranyl acetate. *Biol Trace Elem Res* 36(2): 109-118 (1993).
- B45 Bozal, C.B., A.B. Martinez, R.L. Cabrini et al. Effect of ethane-1-hydroxy-1,1-bisphosphonate (EHBP) on endochondral ossification lesions induced by a lethal oral dose of uranyl nitrate. *Arch Toxicol* 79(8): 475-481 (2005).
- B46 Bradley, E.J. and L.W. Ewers. The transfer and resulting radiation dose from polonium, thorium and other naturally-occurring radionuclides to the human fetus. pp.19-22 in: Health Effects of Internally Deposited Radionuclides: Emphasis on Radium and Thorium, an International Seminar held in Heidelberg, Germany, 18-21 April 1994. World Scientific Publishing Co., Singapore, 1995.
- B47 Bradley, J. and L. Prosser. Radionuclides in human fetal tissues. *Radiol Prot Bull* 148: 28-31 (1993).
- B48 Brady, H.R., B.C. Kone, R.M. Brenner et al. Early effects of uranyl nitrate on respiration and  $\text{K}^+$  transport in rabbit proximal tubule. *Kidney Int* 36(1): 27-34 (1989).
- B49 Brandom, W.F., G. Saccomanno, V.E. Archer et al. Chromosome aberrations in uranium miners occupationally exposed to 222 radon. *Radiat Res* 52(1): 204-215 (1972).
- B50 Briner, W. and K. Byrd. Effects of depleted uranium on development of the mouse. pp.459-461 in: Proceedings of the 6th International Symposium on Metal Ions in Biology and Medicine (J. Centeno et al., eds.). John Libbey Eurotext, Paris, 2000.
- B51 Briner, W. and B. Abboud. Behavior of juvenile mice chronically exposed to depleted uranium. pp.353-356 in: Metal Ions in Biology and Medicine (L. Khassanova et al., eds.). John Libbey Eurotext, Paris, 2002.
- B52 Briner, W. and J. Murray. Effects of short-term and long-term depleted uranium exposure on open-field behavior and brain lipid oxidation in rats. *Neurotoxicol Teratol* 27(1): 135-144 (2005).
- B53 Broadway, J.A. and A.B. Strong. Radionuclides in human bone samples. *Health Phys* 45(3): 765-768 (1983).
- B54 Busby, C., M. Hamdan and E. Ariabi. Cancer, infant mortality and birth sex-ratio in Fallujah, Iraq 2005-2009. *Int J Environ Res Public Health* 7(7): 2828-2837 (2010).
- B55 Bussy, C., P. Lestaevel, B. Dhieux et al. Chronic ingestion of uranyl nitrate perturbs acetylcholinesterase activity and monoamine metabolism in male rat brain. *Neurotoxicology* 27(2): 245-252 (2006).
- C1 Callan, A.C., A.L. Hinwood, M. Ramalingam et al. Maternal exposure to metals-concentrations and predictors of exposure. *Environ Res* 126: 111-117 (2013).

- C2 Cameco Corporation. Beaverlodge Project Annual Report: Year 28 - Transition phase monitoring. Cameco Corporation, Saskatoon, Saskatchewan, 2013.
- C3 Cameco Corporation. Beaverlodge Project Annual Report: Year 29 - Transition phase monitoring. Cameco Corporation, Saskatoon, Saskatchewan, 2014.
- C4 Cameco Corporation. Beaverlodge Project Annual Report: Year 30 - Transition phase monitoring. Cameco Corporation, Saskatoon, Saskatchewan, 2015.
- C5 Canu, I.G., E.D. Ellis and M. Tirmarche. Cancer risk in nuclear workers occupationally exposed to uranium-emphasis on internal exposure. *Health Phys* 94(1): 1-17 (2008).
- C6 Canu, I.G., S. Jacob, E. Cardis et al. Reprocessed uranium exposure and lung cancer risk. *Health Phys* 99(3): 308-313 (2010).
- C7 Carpenter, A.V., W.D. Flanders, E.L. Frome et al. Chemical exposures and central nervous system cancers: a case-control study among workers at two nuclear facilities. *Am J Ind Med* 13(3): 351-362 (1988).
- C8 Carpenter, L., C. Higgins, A. Douglas et al. Combined analysis of mortality in three United Kingdom nuclear industry workforces, 1946-1988. *Radiat Res* 138(2): 224-238 (1994).
- C9 Carpenter, L.M., C.D. Higgins, A.J. Douglas et al. Cancer mortality in relation to monitoring for radionuclide exposure in three UK nuclear industry workforces. *Br J Cancer* 78(9): 1224-32 (1998).
- C10 Carriere, M., C. Thiebault, S. Milgram et al. Citrate does not change uranium chemical speciation in cell culture medium but increases its toxicity and accumulation in NRK-52E cells. *Chem Res Toxicol* 19(12): 1637-1642 (2006).
- C11 Carvalho, F.P., J.M. Oliveira and I. Faria. Alpha emitting radionuclides in drainage from Quinta do Bispo and Cunha Baixa uranium mines (Portugal) and associated radiotoxicological risk. *Bull Environ Contam Toxicol* 83(5): 668-673 (2009).
- C12 Carvalho, F.P. and J.M. Oliveira. Uranium isotopes in the Balkan's environment and foods following the use of depleted uranium in the war. *Environ Int* 36(4): 352-360 (2010).
- C13 Carvalho, I.G., R. Cidu, L. Fanfani et al. Environmental impact of uranium mining and ore processing in the Lagoa Real District, Bahia, Brazil. *Environ Sci Technol* 39(22): 8646-8652 (2005).
- C14 Caserta, D., A. Mantovani, F. Ciardo et al. Heavy metals in human amniotic fluid: a pilot study. *Prenat Diagn* 31(8): 792-796 (2011).
- C15 Catalano, J.G., S.M. Heald, J.M. Zachara et al. Spectroscopic and diffraction study of uranium speciation in contaminated vadose zone sediments from the Hanford site, Washington State. *Environ Sci Technol* 38(10): 2822-2828 (2004).
- C16 CDC. Fourth national report on human exposure to environmental chemicals, Updated tables, February 2015. Department of Health and Human Services, Centers for Disease Control and Prevention, Atlanta, GA, 2015.
- C17 Chan, C., T.S. Hughes, S. Muldoon et al. Mortality patterns among Paducah gaseous diffusion plant workers. *J Occup Environ Med* 52(7): 725-732 (2010).
- C18 Chase, G.R. Correlation between airborne U exposure and U urinalysis results at Bear Creek uranium. *Health Phys* 56(2): 195-199 (1989).
- C19 Chau, N.D. and B. Michalec. Natural radioactivity in bottled natural spring, mineral and therapeutic waters in Poland. *J Radioanal Nucl Chem* 279(1): 121-129 (2009).
- C20 Checkoway, H., N. Pearce, D.J. Crawford-Brown et al. Radiation doses and cause-specific mortality among workers at a nuclear materials fabrication plant. *Am J Epidemiol* 127(2): 255-266 (1988).



- C21 Chen, J., D.P. Meyerhof and B.L. Tracy. Model results of kidney burdens from uranium intakes. *Health Phys* 86(1): 3-11 (2004).
- C22 Chen, J., D. Lariviere, R. Timmins et al. Uranium GI absorption coefficients for young children. IRPA12: 12th Congress of the International Radiation Protection Association: Strengthening Radiation Protection Worldwide - Highlights, Global Perspective and Future Trends, Buenos Aires, Argentina, 19-24 October 2008. IRPA, 2008.
- C23 Chen, J., D. Lariviere, R. Timmins et al. Estimation of uranium GI absorption fractions for children and adults. *Radiat Prot Dosim* 144(1-4): 379-383 (2011).
- C24 Chen, J., D. Moir, R. Lane et al. An ecological study of cancer incidence in Port Hope, Ontario from 1992 to 2007. *J Radiol Prot* 33(1): 227-242 (2013).
- C25 Chung, H.J. and M.G. Lee. Pharmacokinetic changes of ipriflavone in rats with acute renal failure induced by uranyl nitrate. *Biopharm Drug Dispos* 27(7): 345-351 (2006).
- C26 Chung, W., E.J. Kim, I. Lee et al. Effects of recombinant human growth hormone on the pharmacokinetics of intravenous chlorzoxazone in rats with acute renal failure induced by uranyl nitrate. *Life Sci* 73(3): 253-263 (2003).
- C27 CNSC. Understanding health studies and risk assessments conducted in the Port Hope Community from the 1950s to the present. INFO-0781. Canadian Nuclear Safety Commission, Ottawa, Ontario, 2009.
- C28 CNSC. Environmental performance of a uranium mine or mill regulated under the Nuclear Safety and Control Act. Based on environmental data associated with operating uranium mines and mills (2000-2012). NAT24\_VA. Canadian Nuclear Safety Commission, Ottawa, Ontario, 2014.
- C29 Codex. Codex general standard for contaminants and toxins in food and feed. Codex Standard 193-1995. 2013.
- C30 Cooke, N. and F.B. Holt. The solubility of some uranium compounds in simulated lung fluid. *Health Phys* 27(1): 69-77 (1974).
- C31 Cooper, J.R., G.N. Stradling, H. Smith et al. The behaviour of uranium-233 oxide and uranyl-233 nitrate in rats. *Int J Radiat Biol Relat Stud Phys Chem Med* 41(4): 421-433 (1982).
- C32 Corcho Alvarado, J.A., B. Balsiger, S. Röllin et al. Radioactive and chemical contamination of the water resources in the former uranium mining and milling sites of Mailuu Suu (Kyrgyzstan). *J Environ Radioact* 138: 1-10 (2014).
- C33 Coryell, V.H. and D.M. Stearns. Molecular analysis of hprt mutations generated in Chinese hamster ovary EM9 cells by uranyl acetate, by hydrogen peroxide, and spontaneously. *Mol Carcinog* 45(1): 60-72 (2006).
- C34 Cothorn, C.R. and W.L. Lappenbusch. Occurrence of uranium in drinking water in the U.S. *Health Phys* 45(1): 89-99 (1983).
- C35 Craft, E.S., A.W. Abu-Qare, M.M. Flaherty et al. Depleted and natural uranium: Chemistry and toxicological effects. *J Toxicol Environ Health - Part B: Critical Reviews* 7(4): 297-317 (2004).
- C36 Cragle, D.L., R.W. McLain, J.R. Qualters et al. Mortality among workers at a nuclear fuels production facility. *Am J Ind Med* 14(4): 379-401 (1988).
- C37 CSN. Epidemiological study of the possible effect of ionising radiations deriving from the operation of Spanish nuclear fuel cycle facilities on the health of the population living in their vicinity. Summary of the final report. Nuclear Safety Council, Spain, 2009.
- C38 Cuney, M. The extreme diversity of uranium deposits. *Miner Deposita* 44(1): 3-9 (2009).

- D1 Da Silva, M.L. and D.M. Bonotto. Uranium isotopes in groundwater occurring at Amazonas State, Brazil. *Appl Radiat Isot* 97: 24-33 (2015).
- D2 Dabous, A.A., J.K. Osmond and Y.H. Dawood. Uranium/thorium isotope evidence for groundwater history in the Eastern Desert of Egypt. *J Arid Environ* 50(2): 343-357 (2002).
- D3 Damon, E.G., A.F. Eidson, F.F. Hahn et al. Comparison of early lung clearance of yellowcake aerosols in rats with in vitro dissolution and IR analysis. *Health Phys* 46(4): 859-866 (1984).
- D4 Danesi, P.R., A. Markowicz, E. Chinea-Cano et al. Depleted uranium particles in selected Kosovo samples. *J Environ Radioact* 64(2-3): 143-154 (2003).
- D5 Darolles, C., D. Broggio, A. Feugier et al. Different genotoxic profiles between depleted and enriched uranium. *Toxicol Lett* 192(3): 337-348 (2010).
- D6 Davesne, E. Optimisation des programmes de surveillance de la contamination interne par l'étude des incertitudes liées à l'évaluation dosimétrique. Thèse. Rapport DRPH/SDI/2010-11, IRSN/IRSN-2010/135. Laboratoire d'Evaluation de la Dose Interne, IRSN/DRPH/SDI/LEDI, Fontenay-aux-Roses Cedex, 2010.
- D7 Davesne, E. and E. Blanchardon. Physico-chemical characteristics of uranium compounds: A review. *Int J Radiat Biol* 90(11): 975-988 (2014).
- D8 Davesne, E., N. Blanchin, E. Chojnacki et al. Collective dosimetry to distinguish occupational exposure to natural uranium from alimentary uranium background in bioassay measurements. *Int J Radiat Biol* 90(11): 1048-1054 (2014).
- D9 Davis, M.W. Correlation analysis of first phase monitoring results for uranium mill workers. Prepared by Monserco Limited under contract to the Atomic Energy Control Board. INFO-0098. Atomic Energy Control Board, Ottawa, 1983.
- D10 De Rey, B.M., H.E. Lanfranchi and R.L. Cabrini. Percutaneous absorption of uranium compounds. *Environ Res* 30(2): 480-491 (1983).
- D11 Desideri, D., M.A. Meli, L. Feduzi et al.  $^{238}\text{U}$ ,  $^{234}\text{U}$ ,  $^{226}\text{Ra}$ ,  $^{210}\text{Po}$  concentrations of bottled mineral waters in Italy and their dose contribution. *J Environ Radioact* 94(2): 86-97 (2007).
- D12 Diamond, G.L., P.E. Morrow, B.J. Panner et al. Reversible uranyl fluoride nephrotoxicity in the Long Evans rat. *Fundam Appl Toxicol*. 13(1): 65-78 (1989).
- D13 Dias da Cunha, K.M., H. Henderson, B.M. Thomson et al. Ground water contamination with  $^{238}\text{U}$ ,  $^{234}\text{U}$ ,  $^{235}\text{U}$ ,  $^{226}\text{Ra}$  and  $^{210}\text{Pb}$  from past uranium mining: Cove wash, Arizona. *Environ Geochem Health* 36(3): 477-487 (2014).
- D14 Díaz-Francés, I., J. Mantero, G. Manjón et al.  $^{210}\text{Po}$  and  $^{238}\text{U}$  Isotope concentrations in commercial bottled mineralwater samples in Spain and their dose contribution. *Radiat Prot Dosim* 156(3): 336-342 (2013).
- D15 Diaz Sylvester, P.L., R. Lopez, A.M. Ubios et al. Exposure to subcutaneously implanted uranium dioxide impairs bone formation. *Arch Environ Health* 57(4): 320-325 (2002).
- D16 Dinocourt, C., M. Legrand, I. Dublineau et al. The neurotoxicology of uranium. *Toxicology* 337: 58-71 (2015).
- D17 Domingo, J.L., J.M. Llobet, J.M. Tomas et al. Acute toxicity of uranium in rats and mice. *Bull Environ Contam Toxicol* 39(1): 168-174 (1987).
- D18 Domingo, J.L., A. Ortega, J.L. Paternain et al. Evaluation of the perinatal and postnatal effects of uranium in mice upon oral administration. *Arch Environ Health* 44(6): 395-398 (1989).
- D19 Donnadiou-Claraz, M., M. Bonnehogne, B. Dhieux et al. Chronic exposure to uranium leads to iron accumulation in rat kidney cells. *Radiat Res* 167(4): 454-464 (2007).

- D20 Donoghue, J.K., E.D. Dyson, J.S. Hislop et al. Human exposure to natural uranium. A case history and analytical results from some postmortem tissues. *Br J Ind Med* 29(1): 81-89 (1972).
- D21 Downs, W.L., H.B. Wilson, G.E. Sylvester et al. Excretion of uranium by rats following inhalation of uranium dioxide. *Health Phys* 13(5): 445-453 (1967).
- D22 Dreesen, D.R., J.M. Williams, M.L. Marple et al. Mobility and bioavailability of uranium mill tailings contaminants. *Environ Sci Technol* 16(10): 702-709 (1982).
- D23 Drubay, D., S. Ancelet, A. Acker et al. Kidney cancer mortality and ionizing radiation among French and German uranium miners. *Radiat Environ Biophys* 53(3): 505-513 (2014).
- D24 Drubay, D., S. Caer-Lorho, P. Laroche et al. Mortality from circulatory system diseases among French uranium miners: A nested case-control study. *Radiat Res* 183(5): 550-562 (2015).
- D25 Dublineau, I., S. Grison, C. Baudelin et al. Absorption of uranium through the entire gastrointestinal tract of the rat. *Int J Radiat Biol* 81(6): 473-482 (2005).
- D26 Dublineau, I., S. Grison, L. Grandcolas et al. Absorption, accumulation and biological effects of depleted uranium in Peyer's patches of rats. *Toxicology* 227(3): 227-239 (2006).
- D27 Dublineau, I., S. Grison, C. Linard et al. Short-term effects of depleted uranium on immune status in rat intestine. *J Toxicol Environ Health A* 69(17): 1613-1628 (2006).
- D28 Dublineau, I., L. Grandcolas, S. Grison et al. Modifications of inflammatory pathways in rat intestine following chronic ingestion of depleted uranium. *Toxicol Sci* 98(2): 458-468 (2007).
- D29 Dublineau, I., M. Souidi, Y. Gueguen et al. Unexpected lack of deleterious effects of uranium on physiological systems following a chronic oral intake in adult rat. *Biomed Res Int* 2014: 181989 (2014).
- D30 Dufey, F., L. Walsh, A. Tschense et al. Occupational doses of ionizing radiation and leukemia mortality. *Health Phys* 100(5): 548-550; author reply 550-541 (2011).
- D31 Dufey, F., L. Walsh, M. Sogl et al. Radiation dose dependent risk of liver cancer mortality in the German uranium miners cohort 1946-2003. *J Radiol Prot* 33(1): 175-185 (2013).
- D32 Duport, P., R. Robertson, K. Ho et al. Flow-through dissolution of uranium-thorium ore dust, uranium concentrate, uranium dioxide, and thorium alloy in simulated lung fluid. *Radiat Prot Dosim* 38(1-3): 121-133 (1991).
- D33 Dupree-Ellis, E., J. Watkins, J.N. Ingle et al. External radiation exposure and mortality in a cohort of uranium processing workers. *Am J Epidemiol* 152(1): 91-95 (2000).
- D34 Dupree, E.A., D.L. Cragle, R.W. McLain et al. Mortality among workers at a uranium processing facility, the Linde Air Products Company Ceramics Plant, 1943-1949. *Scand J Work Environ Health* 13(2): 100-107 (1987).
- D35 Dupree, E.A., J.P. Watkins, J.N. Ingle et al. Uranium dust exposure and lung cancer risk in four uranium processing operations. *Epidemiology* 6(4): 370-375 (1995).
- D36 Dygert, H. Concepts in inhalation toxicology. pp.603-700 in: *Pharmacology and Toxicology of Uranium Compounds* (C. Voegtlin and H. Hodge, eds.). McGraw-Hill Book Co., Inc., New York, 1949.
- E1 Eadie, G.G. and R.F. Kaufmann. Radiological evaluation of the effects of uranium mining and milling operations on selected ground water supplies in the Grants Mineral Belt, New Mexico. *Health Phys* 32(4): 231-241 (1977).
- E2 EFSA. Uranium in foodstuffs, in particular mineral water. Scientific opinion of the panel on contaminants in the food chain. *EFSA Journal* 7(4): 1-59 (2009).
- E3 Ellender, M. The clearance of uranium after deposition of the nitrate and bicarbonate in different regions of the rat lung. *Hum Toxicol* 6(6): 479-482 (1987).

- E4 Ellender, M., J.D. Harrison, H. Pottinger et al. Induction of osteosarcoma and acute myeloid leukaemia in CBA/H mice by the alpha-emitting nuclides, uranium-233, plutonium-239 and americium-241. *Int J Radiat Biol* 77(1): 41-52 (2001).
- E5 Esposito, M., P. Polić, P. Bartolomei et al. Survey of natural and anthropogenic radioactivity in environmental samples from Yugoslavia. *J Environ Radioact* 61(3): 271-282 (2002).
- E6 Essien, I.O., D.N. Sandoval and P.K. Kuroda. Deposition of excess amount of natural U from the atmosphere. *Health Phys* 48(3): 325-331 (1985).
- F1 Fathi, R.A., L.Y. Matti, H.S. Al-Salih et al. Environmental pollution by depleted uranium in Iraq with special reference to Mosul and possible effects on cancer and birth defect rates. *Med Confl Surviv* 29(1): 7-25 (2013).
- F2 Feugier, A., S. Frelon, P. Gourmelon et al. Alteration of mouse oocyte quality after a subchronic exposure to depleted uranium. *Reprod Toxicol* 26(3-4): 273-277 (2008).
- F3 Filipy, R.E. and J.J. Russell. The United States Transuranium and Uranium Registries as sources for actinide dosimetry and bioeffects. *Radiat Prot Dosim* 105(1-4): 185-187 (2003).
- F4 Fisenne, I.M. and G.A. Welford. Natural U concentrations in soft tissues and bone of New York City residents. *Health Phys* 50(6): 739-746 (1986).
- F5 Fisenne, I.M., P.M. Perry, K.M. Decker et al. The daily intake of  $^{234,235,238}\text{U}$ ,  $^{228,230,232}\text{Th}$  and  $^{226,228}\text{Ra}$  by New York City residents. *Health Phys* 53(4): 357-363 (1987).
- F6 Fisenne, I.M., P.M. Perry and N.H. Harley. Uranium in humans. *Radiat Prot Dosim* 24(1-4): 127-131 (1988).
- F7 Fisenne, I.M. The natural radiation environment. Proceedings of the Fifth International Symposium on the Natural Radiation Environment, 22-28 September 1991, Salzburg, Salzburg, Austria, 1991.
- F8 Fitsanakis, V.A., K.M. Erikson, S.J. Garcia et al. Brain accumulation of depleted uranium in rats following 3- or 6-month treatment with implanted depleted uranium pellets. *Biol Trace Elem Res* 111(1-3): 185-197 (2006).
- F9 Fitzgerald, J. Groundwater quality and environmental health implications, Anangu Pitjantjatjara lands, South Australia. Bureau of Rural Sciences, Canberra, 2000.
- F10 Fraser, P., L. Carpenter, N. Maconochie et al. Cancer mortality and morbidity in employees of the United Kingdom Atomic Energy Authority, 1946-86. *Br J Cancer* 67(3): 615-624 (1993).
- F11 Frelon, S., P. Houpert, D. Lepetit et al. The chemical speciation of uranium in water does not influence its absorption from the gastrointestinal tract of rats. *Chem Res Toxicol* 18(7): 1150-1154 (2005).
- F12 Frengstad, B., A.K. Skrede, D. Banks et al. The chemistry of Norwegian groundwaters: III. The distribution of trace elements in 476 crystalline bedrock groundwaters, as analysed by ICP-MS techniques. *Sci Total Environ* 246(1): 21-40 (2000).
- F13 Frengstad, B.S., K. Lax, T. Tarvainen et al. The chemistry of bottled mineral and spring waters from Norway, Sweden, Finland and Iceland. *J Geochem Explor* 107(3): 350-361 (2010).
- F14 Frisbie, S.H., E.J. Mitchell, L.J. Mastera et al. Public health strategies for western Bangladesh that address arsenic, manganese, uranium, and other toxic elements in drinking water. *Environ Health Perspect* 117(3): 410-416 (2009).
- F15 Frisbie, S.H., E.J. Mitchell and B. Sarkar. World Health Organization increases its drinking-water guideline for uranium. *Environ Sci Process Impacts* 15(10): 1817-1823 (2013).

- F16 Froidevaux, P., J.J. Geering, L. Pillonel et al.  $^{90}\text{Sr}$ ,  $^{238}\text{U}$ ,  $^{234}\text{U}$ ,  $^{137}\text{Cs}$ ,  $^{40}\text{K}$  and  $^{239/240}\text{Pu}$  in Emmental type cheese produced in different regions of Western Europe. *J Environ Radioact* 72(3): 287-298 (2004).
- F17 Fukuda, S., H. Iida, M. Ikeda et al. Toxicity of uranium and the removal effects of CBMIDA and EHBP in simulated wounds of rats. *Health Phys* 89(1): 81-88 (2005).
- F18 Fukuda, S., M. Ikeda, M. Chiba et al. Clinical diagnostic indicators of renal and bone damage in rats intramuscularly injected with depleted uranium. *Radiat Prot Dosim* 118(3): 307-314 (2006).
- G1 Galle, P. *Toxiques Nucléaires*. Masson, 1997. (French).
- G2 Gans, I. Natural radionuclides in mineral waters. *Sci Total Environ* 45: 93-99 (1985).
- G3 Garg, V.K., A. Yadav, K. Singh et al. Uranium concentration in groundwater in Hisar city, India. *Int J Occup Environ Med* 5(2): 112-114 (2014).
- G4 Garnier-Laplace, J., R. Gilbin, C. Della-Vedova et al. Bioavailability in ecological risk. Assessment for radionuclides. pp.41-57 in: *Scientific Trends in Radiological Protection of the Environment: ECORAD 2004 - International Conference on the Scientific Basis for Environment Protection Against Ionising Radiation*, Aix-en-Provence, France. TEC&DOC, Lavoisier, 2005.
- G5 Gazin, V., S. Kerdine, G. Grillon et al. Uranium induces TNF alpha secretion and MAPK activation in a rat alveolar macrophage cell line. *Toxicol Appl Pharmacol* 194(1): 49-59 (2004).
- G6 Gegner, M. and K. Irlweck. Uranium concentrations and isotopic ratios in Austrian drinking waters. *Radioact Environ* 7: 135-139 (2005).
- G7 Gharbi, F., S. Baccouche, W. Abdelli et al. Uranium isotopes in Tunisian bottled mineral waters. *J Environ Radioact* 101(8): 589-590 (2010).
- G8 Ghosh, S., A. Kumar, B.N. Pandey et al. Acute exposure of uranyl nitrate causes lipid peroxidation and histopathological damage in brain and bone of Wistar rat. *J Environ Pathol Toxicol Oncol* 26(4): 255-261 (2007).
- G9 Giglio, M.J., N. Brandan, T.L. Leal et al. The mechanism of the transient depression of the erythropoietic rate induced in the rat by a single injection of uranyl nitrate. *Toxicol Appl Pharmacol* 99(2): 260-265 (1989).
- G10 Gilman, A.P., M.A. Moss, D.C. Villeneuve et al. Uranyl nitrate: 91-day exposure and recovery studies in the male New Zealand white rabbit. *Toxicol Sci* 41(1): 138-151 (1998).
- G11 Gilman, A.P., D.C. Villeneuve, V.E. Secours et al. Uranyl nitrate: 28-day and 91-day toxicity studies in the Sprague-Dawley rat. *Toxicol Sci* 41(1): 117-128 (1998).
- G12 Giri, S., G. Singh and V.N. Jha. Evaluation of radionuclides in groundwater around proposed uranium mining sites in Bagjata and Banduhurang, Jharkhand (India). *Radioprotection* 46(1): 39-57 (2011).
- G13 Giri, S., V.N. Jha, G. Singh et al. Estimation of annual effective dose due to ingestion of natural radionuclides in foodstuffs and water at a proposed uranium mining site in India. *Int J Radiat Biol* 89(12): 1071-1078 (2013).
- G14 Godoy, M.L., J.M. Godoy, R. Kowsmann et al.  $^{234}\text{U}$  and  $^{230}\text{Th}$  determination by FIA-ICP-MS and application to uranium-series disequilibrium in marine samples. *J Environ Radioact* 88(2): 109-117 (2006).
- G15 Goel, K.A., V.K. Garg and V. Garg. Histopathology of kidney of albino rat poisoned with uranyl nitrate. *Bull Environ Contam Toxicol* 24(1): 9-12 (1980).
- G16 Golchert, N.W., T.L. Duffy and J. Sedlet. Environmental monitoring at Argonne National Laboratory. ANL-85-17. Argonne National Laboratory, Illinois, USA, 1985.

- G17 Goldman, M., A. Yaari, Z. Doshnitzki et al. Nephrotoxicity of uranyl acetate: effect on rat kidney brush border membrane vesicles. *Arch Toxicol* 80(7): 387-393 (2006).
- G18 Gonçalves, M.M., M. Gerenutti and M.M.D. Carvalho Vila. Uranium: Natural occurrence, physical and chemical characteristics, environmental contamination and human exposure. pp.185-209 in: *Uranium: Characteristics, Occurrence and Human Exposure*. Nova Science Publishers, 2012.
- G19 Greenland, S. and H. Morgenstern. Ecological bias, confounding, and effect modification. *Int J Epidemiol* 18(1): 269-274 (1989).
- G20 Grignard, E., Y. Gueguen, S. Grison et al. Contamination with depleted or enriched uranium differently affects steroidogenesis metabolism in rat. *Int J Toxicol* 27(4): 323-328 (2008).
- G21 Grison, S., G. Fave, M. Maillot et al. Metabolomics identifies a biological response to chronic low-dose natural uranium contamination in urine samples. *Metabolomics* 9: 1168-1180 (2013).
- G22 Guan, H. and F. Piao. Maternal and fetal exposure to uranium in Dalian, China. *Acta Obstet Gynecol Scand* 90(8): 924-925 (2011).
- G23 Gueguen, Y., F. Paquet, P. Voisin et al. Effects of chronic contamination with depleted uranium on xenobiotic biotransformation enzymes in the rat. in: *Proceedings of the 14th International Conference on Cytochromes P450: Biochemistry, Biophysics and Bioinformatics*, Dallas, Texas, 2005. Medimond International Proceedings, Bologna, Italy, 2005.
- G24 Gueguen, Y., K. Mouzat, L. Ferrari et al. Cytochromes P450: xenobiotic metabolism, regulation and clinical importance. *Ann Biol Clin (Paris)* 64(6): 535-548 (2006). (French).
- G25 Gueguen, Y., M. Souidi, C. Baudelin et al. Short-term hepatic effects of depleted uranium on xenobiotic and bile acid metabolizing cytochrome P450 enzymes in the rat. *Arch Toxicol* 80(4): 187-195 (2006).
- G26 Gueguen, Y., L. Grandcolas, C. Baudelin et al. Effect of acetaminophen administration to rats chronically exposed to depleted uranium. *Toxicology* 229(1-2): 62-72 (2007).
- G27 Gueguen, Y. and C. Rouas. New data on uranium nephrotoxicity. *Radioprotection* 47(3): 345-359 (2012). (French).
- G28 Gueguen, Y., C. Rouas and F.A. Leblond. Kidney injury biomarkers. *Nephrologie et Therapeutique* 8(3): 146-155 (2012).
- G29 Gueguen, Y., C. Rouas, A. Monin et al. Molecular, cellular, and tissue impact of depleted uranium on xenobiotic-metabolizing enzymes. *Arch Toxicol* 88(2): 227-239 (2014).
- G30 Gueguen, Y., D. Suhard, C. Poisson et al. Low-concentration uranium enters the HepG2 cell nucleus rapidly and induces cell stress response. *Toxicol In Vitro* 30(1 Pt B): 552-560 (2015).
- G31 Guseva Canu, I., E. Cardis, C. Metz-Flamant et al. French cohort of the uranium processing workers: mortality pattern after 30-year follow-up. *Int Arch Occup Environ Health* 83(3): 301-308 (2010).
- G32 Guseva Canu, I., S. Jacob, E. Cardis et al. Uranium carcinogenicity in humans might depend on the physical and chemical nature of uranium and its isotopic composition: results from pilot epidemiological study of French nuclear workers. *Cancer Causes Control* 22(11): 1563-1573 (2011).
- G33 Guseva Canu, I., J.P. Garsi, S. Caër-Lohro et al. Does uranium induce circulatory diseases? First results from a French cohort of uranium workers. *Occup Environ Med* 69(6): 404-409 (2012).
- H1 Habert, R., V. Muczynski, T. Grisin et al. Concerns about the widespread use of rodent models for human risk assessments of endocrine disruptors. *Reproduction* 147(4): R119-R129 (2014).

- H2 Hadad, K. and R. Doulatdar. U-series concentration in surface and ground water resources of Ardabil province. *Radiat Prot Dosim* 130(3): 309-318 (2008).
- H3 Hahn, F.F., R.A. Guilmette and M.D. Hoover. Implanted depleted uranium fragments cause soft tissue sarcomas in the muscles of rats. *Environ Health Perspect* 110(1): 51-59 (2002).
- H4 Hakam, O.K., A. Choukri, J.L. Reyss et al. Determination and comparison of uranium and radium isotopes activities and activity ratios in samples from some natural water sources in Morocco. *J Environ Radioact* 57(3): 175-189 (2001).
- H5 Hakonson-Hayes, A.C., P.R. Fresquez and F.W. Whicker. Assessing potential risks from exposure to natural uranium in well water. *J Environ Radioact* 59(1): 29-40 (2002).
- H6 Haley, D.P., R.E. Bulger and D.C. Dobyan. The long-term effects of uranyl nitrate on the structure and function of the rat kidney. *Virchows Arch B Cell Pathol Incl Mol Pathol* 41(1-2): 181-192 (1982).
- H7 Ham, G.J., S.A. Hodgson, M.J. Youngman et al. Review of autopsy, in vivo and bioassay measurements on members of the public in the UK. NRPB-W42. National Radiological Protection Board, Chilton, Didcot, 2003.
- H8 Hamilton, E.I. The concentration of uranium in man and his diet. *Health Phys* 22(2): 149-153 (1972).
- H9 Hao, Y., R. Li, Y. Leng et al. A study assessing the genotoxicity in rats after chronic oral exposure to a low dose of depleted uranium. *J Radiat Res* 50(6): 521-528 (2009).
- H10 Hao, Y., R. Li, Y. Leng et al. The reproductive effects in rats after chronic oral exposure to low-dose depleted uranium. *J Radiat Res* 53(3): 377-384 (2012).
- H11 Hao, Y., J. Ren, J. Liu et al. Immunological changes of chronic oral exposure to depleted uranium in mice. *Toxicology* 309: 81-90 (2013).
- H12 Harley, N.H. and I.M. Fisenne. Distribution and alpha radiation dose from naturally occurring U, Th, and Ra in the human skeleton. *Health Phys* 58(4): 515-518 (1990).
- H13 Harley, N.H., E.C. Foulkes, L.H. Hilborne et al. Depleted uranium, Volume 7. in: *A Review of the Scientific Literature as it Pertains to Gulf War Illness*. National Defense Research Institute, Washington, 1999.
- H14 Hart, D.R., P.M. McKee and A.J. Burt. Benthic community and sediment quality assessment of Port Hope Harbour, Lake Ontario. *J Great Lakes Res* 12: 206-220 (1986).
- H15 Hartsock, W.J., J.D. Cohen and D.J. Segal. Uranyl acetate as a direct inhibitor of DNA-binding proteins. *Chem Res Toxicol* 20(5): 784-789 (2007).
- H16 HC. Guidelines for Canadian drinking water quality: Guideline technical document - Radiological parameters. Radiation Protection Bureau, Healthy Environments and Consumer Safety Branch, Health Canada, Ottawa, Ontario 2009.
- H17 Herranz, M., A. Abelairas and F. Legarda. Uranium contents and associated effective doses in drinking water from Biscay (Spain). *Appl Radiat Isot* 48(6): 857-886 (1997).
- H18 Hines, S.E., P. Gucer, S. Kligerman et al. Pulmonary health effects in Gulf War I service members exposed to depleted Uranium. *J Occup Environ Med* 55(8): 937-944 (2013).
- H19 Hirose, K. and Y. Sugimura. Concentration of uranium and the activity ratio of  $^{234}\text{U}/^{238}\text{U}$  in surface air: effect of atmospheric burn-up of Cosmos-954. *Meteorol Geophys* 32(4): 317-322 (1981).
- H20 Hodgson, A., J.C. Moody, G.N. Stradling et al. Application of the ICRP respiratory tract model to uranium compounds produced during the manufacture of nuclear fuel. NRPB-M1156. Chilton, Didcot, 2000.

- H21 Hollriegl, V., A.M. Arogunjo, A. Giussani et al. Daily urinary excretion of uranium in members of the public of Southwest Nigeria. *Sci Total Environ* 412-413: 344-350 (2011).
- H22 Homma-Takeda, S., T. Kokubo, Y. Terada et al. Uranium dynamics and developmental sensitivity in rat kidney. *J Appl Toxicol* 33(7): 685-694 (2013).
- H23 Homma-Takeda, S., K. Kitahara, K. Suzuki et al. Cellular localization of uranium in the renal proximal tubules during acute renal uranium toxicity. *J Appl Toxicol* 35(12): 1594-1600 (2015).
- H24 Houpert, P., P. Lestaevel, C. Bussy et al. Enriched but not depleted uranium affects central nervous system in long-term exposed rat. *Neurotoxicology* 26(6): 1015-1020 (2005).
- H25 Houpert, P., S. Frelon, P. Lestaevel et al. Parental exposure to enriched uranium induced delayed hyperactivity in rat offspring. *Neurotoxicology* 28(1): 108-113 (2007).
- H26 Houpert, P., S. Frelon, M. Monleau et al. Heterogeneous accumulation of uranium in the brain of rats. *Radiat Prot Dosim* 127(1-4): 86-89 (2007).
- H27 Hu, Q.Y. and S.P. Zhu. Induction of chromosomal aberrations in male mouse germ cells by uranyl fluoride containing enriched uranium. *Mutat Res* 244(3): 209-214 (1990).
- H28 Hu, Q.Y. and S.P. Zhu. Detection of DNA damage in spermiogenic stages of mice treated with enriched uranyl fluoride by alkaline elution. *Radiat Environ Biophys* 29(3): 161-167 (1990).
- I1 IAEA. Effects of ionising radiation on plants and animals at levels implied by current radiation protection standards. Technical Reports Series No. 332. International Atomic Energy Agency, Vienna, 1992.
- I2 IAEA. Radiological conditions in areas of Kuwait with residues of depleted uranium. Radiological assessment reports series. International Atomic Energy Agency, Vienna, 2003.
- I3 IAEA. Handbook of parameter values for the prediction of radionuclide transfer to wildlife. Technical Reports Series No. 479. International Atomic Energy Agency, Vienna, 2014.
- I4 IAEA. Radiation protection and safety of radiation sources: International basic safety standards. IAEA Safety Standards Series No. GSR Part 3. International Atomic Energy Agency, Vienna, 2014.
- I5 IARC. A review of human carcinogens. Part D: Radiation. IARC Monographs on the Evaluation of Carcinogenic Risks to Humans, Volume 100D. International Agency for Research on Cancer, Lyon, 2012.
- I6 Ibanez, C., D. Suhard, C. Tessier et al. Intranasal exposure to uranium results in direct transfer to the brain along olfactory nerve bundles. *Neuropathol Appl Neurobiol* 40(4): 477-488 (2014).
- I7 ICRP. Dose coefficients for intakes of radionuclides by workers. ICRP Publication 68. Annals of the ICRP 24(4). International Commission on Radiological Protection, Pergamon Press, Oxford, 1994.
- I8 ICRP. Human respiratory tract model for radiological protection. ICRP Publication 66. Annals of the ICRP 24(1-3). International Commission on Radiological Protection, Pergamon Press, Oxford, 1994.
- I9 ICRP. Age-dependent doses to members of the public from intake of radionuclides: Part 4. Inhalation dose coefficients. ICRP Publication 71. Annals of the ICRP 25(3-4). International Commission on Radiological Protection, Pergamon Press, Oxford, 1995.
- I10 ICRP. Age-dependent doses to members of the public from intake of radionuclides: Part 3. Ingestion dose coefficients. ICRP Publication 69. Annals of the ICRP 25(1). International Commission on Radiological Protection, Pergamon Press, Oxford, 1995.



- I11 ICRP. Age-dependent doses to members of the public from intake of radionuclides: Part 5. Compilation of ingestion and inhalation dose coefficients. ICRP Publication 72. *Annals of the ICRP* 26(1). International Commission on Radiological Protection, Pergamon Press, Oxford, 1995.
- I12 ICRP. Doses to the embryo and fetus from intakes of radionuclides by the mother. ICRP Publication 88. *Annals of the ICRP* 31(1-3). International Commission on Radiological Protection, Pergamon Press, Oxford, 2001.
- I13 ICRP. Doses to infants from ingestion of radionuclides in mothers' milk. ICRP Publication 95. *Annals of the ICRP* 34(3-4). International Commission on Radiological Protection, Elsevier Ltd., 2004.
- I14 ICRP. Human alimentary tract model for radiological protection. ICRP Publication 100. *Annals of the ICRP* 36(1-2). International Commission on Radiological Protection, Elsevier Ltd., 2006.
- I15 ICRP. The 2007 Recommendations of the International Commission on Radiological Protection. ICRP Publication 103. *Annals of the ICRP* 37(2-4). International Commission on Radiological Protection, Elsevier Ltd., 2007.
- I16 ICRP. Lung cancer risk from radon and progeny and statement on radon. ICRP Publication 115. *Annals of the ICRP* 40(1). International Commission on Radiological Protection, Elsevier Ltd., 2010.
- I17 ICRP. Radiological protection against radon exposure. ICRP Publication 126. *Annals of the ICRP* 43(3). International Commission on Radiological Protection, Elsevier Ltd., 2014.
- I18 Igarashi, Y., A. Yamakawa and N. Ikeda. Plutonium and uranium in Japanese human tissues. *Radioisotopes* 36(9): 433-439 (1987).
- I19 Igarashi, Y., A. Yamakawa, C. Kim et al. Distribution of uranium in human lungs. *Radioisotopes* 36(10): 501-504 (1987).
- I20 IOM. Gulf War and Health: Updated Literature Review of Depleted Uranium. Institute of Medicine, The National Academies Press, Washington, D.C., 2008.
- I21 IRSN. Deuxième bilan 2008-2009 de la qualité radiologique des eaux du robinet en France. in: *La qualité radiologique de l'eau du robinet en France, 2008-2009*. Institut de Radioprotection et de Sécurité Nucléaire, 2011. (French).
- I22 Isam Salih, M.M., H.B.L. Pettersson and E. Lund. Uranium and thorium series radionuclides in drinking water from drilled bedrock wells: Correlation to geology and bedrock radioactivity and dose estimation. *Radiat Prot Dosim* 102(3): 249-258 (2002).
- I23 Israelsson, A. and H. Pettersson. Measurements of  $^{234}\text{U}$  and  $^{238}\text{U}$  in hair, urine, and drinking water among drilled bedrock well water users for the evaluation of hair as a biomonitor of Uranium intake. *Health Phys* 107(2): 143-149 (2014).
- J1 Jadon, A. and R. Mathur. Gametogenic count and histopathological effect of thorium nitrate and uranyl nitrate on mice testes. *Andrologia* 15(1): 40-43 (1983).
- J2 Jia, G., M. Belli, U. Sansone et al. Concentration and characteristics of depleted uranium in biological and water samples collected in Bosnia and Herzegovina. *J Environ Radioact* 89(2): 172-187 (2006).
- J3 Joksić, A.S. and S.A. Katz. Efficacy of hair analysis for monitoring exposure to uranium: A mini-review. *J Environ Sci Health A Tox Hazard Subst Environ Eng* 49(13): 1578-1587 (2014).
- J4 Jovanovic, S.V., P. Pan and L. Wong. Bioaccessibility of uranium in soil samples from Port Hope, Ontario, Canada. *Environ Sci Technol* 46(16): 9012-9018 (2012).

- J5 Jowzaee, S. Determination of selected natural radionuclide concentrations in southwestern caspian groundwater using liquid scintillation counting. *Radiat Prot Dosim* 157(2): 234-241 (2013).
- J6 Julião, L.M.Q.C., D.R. Melo, W.D.O. Sousa et al. Uncertainty on faecal analysis on dose assessment. *Radiat Prot Dosim* 127(1-4): 421-424 (2007).
- K1 Kansal, S., R. Mehra and N.P. Singh. Uranium concentration in ground water samples belonging to some areas of Western Haryana, India using fission track registration technique. *J Public Health Epidemiol* 3(8): 352-357 (2011).
- K2 Karpas, Z., O. Paz-Tal, A. Lorber et al. Urine, hair, and nails as indicators for ingestion of uranium in drinking water. *Health Phys* 88(3): 229-242 (2005).
- K3 Karpas, Z. *Analytical Chemistry of Uranium: Environmental, Forensic, Nuclear, and Toxicological Applications*. CRC Press, Taylor & Francis Group, Boca Raton, 2015.
- K4 Kathren, R.L. and R.H. Moore. Acute accidental inhalation of U: a 38-year follow-up. *Health Phys* 51(5): 609-619 (1986).
- K5 Kathren, R.L. and R.K. Burklin. Acute chemical toxicity of uranium. *Health Phys* 94(2): 170-179 (2008).
- K6 Kathren, R.L. and S.Y. Tolmachev. Natural uranium tissue content of three Caucasian males. *Health Phys* 109(3): 187-197 (2015).
- K7 Katsoyiannis, I.A., S.J. Hug, A. Ammann et al. Arsenic speciation and uranium concentrations in drinking water supply wells in Northern Greece: Correlations with redox indicative parameters and implications for groundwater treatment. *Sci Total Environ* 383(1-3): 128-140 (2007).
- K8 Kayzar, T.M., A.C. Villa, M.L. Lobaugh et al. Investigating uranium distribution in surface sediments and waters: a case study of contamination from the Juniper Uranium Mine, Stanislaus National Forest, CA. *J Environ Radioact* 136: 85-97 (2014).
- K9 Konietzka, R. Gastrointestinal absorption of uranium compounds--a review. *Regul Toxicol Pharmacol* 71(1): 125-133 (2015).
- K10 Kozłowska, B., A. Walencik and J. Dorda. Natural radioactivity and dose estimation in underground water from the Sudety Mountains in Poland. *Radiat Prot Dosim* 128(3): 331-335 (2008).
- K11 Krachler, M. and W. Shotyk. Trace and ultratrace metals in bottled waters: Survey of sources worldwide and comparison with refillable metal bottles. *Sci Total Environ* 407(3): 1089-1096 (2009).
- K12 Kraiem, M., S. Richter, N. Erdmann et al. Characterizing uranium oxide reference particles for isotopic abundances and uranium mass by single particle isotope dilution mass spectrometry. *Anal Chim Acta* 748: 37-44 (2012).
- K13 Kramer, G.H., B.M. Hauck, S.A. Allen et al. Lung counting: summing techniques to reduce the MDA. *Health Phys* 85(2): 220-227 (2003).
- K14 Kreuzer, M., M. Kreisheimer, M. Kandel et al. Mortality from cardiovascular diseases in the German uranium miners cohort study, 1946-1998. *Radiat Environ Biophys* 45(3): 159-166 (2006).
- K15 Kreuzer, M., K. Straif, J.W. Marsh et al. Occupational dust and radiation exposure and mortality from stomach cancer among German uranium miners, 1946-2003. *Occup Environ Med* 69(3): 217-223 (2012).

- K16 Kreuzer, M., F. Dufey, M. Sogl et al. External gamma radiation and mortality from cardiovascular diseases in the German WISMUT uranium miners cohort study, 1946-2008. *Radiat Environ Biophys* 52(1): 37-46 (2013).
- K17 Kreuzer, M., F. Dufey, J.W. Marsh et al. Mortality from cancers of the extra-thoracic airways in relation to radon progeny in the Wismut cohort, 1946-2008. *Int J Radiat Biol* 90(11): 1030-1035 (2014).
- K18 Kreuzer, M., F. Dufey, D. Laurier et al. Mortality from internal and external radiation exposure in a cohort of male German uranium millers, 1946-2008. *Int Arch Occup Environ Health* 88(4): 431-441 (2015).
- K19 Kronfeld, J., D.I. Godfrey-Smith, D. Johannessen et al. Uranium series isotopes in the Avon Valley, Nova Scotia. *J Environ Radioact* 73(3): 335-352 (2004).
- K20 Krunic, A., S. Haveric and S. Ibrulj. Micronuclei frequencies in peripheral blood lymphocytes of individuals exposed to depleted uranium. *Arh Hig Rada Toksikol* 56(3): 227-232 (2005).
- K21 Kryscio, A., W.U. Ulrich Muller, A. Wojcik et al. A cytogenetic analysis of the long-term effect of uranium mining on peripheral lymphocytes using the micronucleus-centromere assay. *Int J Radiat Biol* 77(11): 1087-1093 (2001).
- K22 Kumar, M., A. Kumar, S. Singh et al. Uranium content measurement in drinking water samples using track etch technique. *Radiat Meas* 36: 479-481 (2003).
- K23 Kundt, M., A.M. Ubios and R.L. Cabrini. Effects of uranium poisoning on cultured preimplantation embryos. *Biol Trace Elem Res* 75(1-3): 235-244 (2000).
- K24 Kundt, M.S., C. Martinez-Taibo, M.C. Muhlmann et al. Uranium in drinking water: Effects on mouse oocyte quality. *Health Phys* 96(5): 568-574 (2009).
- K25 Kupsh, C.C. and G.A. Robinson. Linearity of the accumulation of various dosages of uranium in the major organs of mature male Japanese quail. Effect of various doses of estradiol-17 beta. *Comp Biochem Physiol C* 92(1): 55-59 (1989).
- K26 Kurttio, P., A. Auvinen, L. Salonen et al. Renal effects of uranium in drinking water. *Environ Health Perspect* 110(4): 337-342 (2002).
- K27 Kurttio, P., H. Komulainen, A. Leino et al. Bone as a possible target of chemical toxicity of natural uranium in drinking water. *Environ Health Perspect* 113(1): 68-72 (2005).
- K28 Kurttio, P., A. Harmoinen, H. Saha et al. Kidney toxicity of ingested uranium from drinking water. *Am J Kidney Dis* 47(6): 972-982 (2006).
- K29 Kurttio, P., L. Salonen, T. Ilus et al. Well water radioactivity and risk of cancers of the urinary organs. *Environ Res* 102(3): 333-338 (2006).
- K30 Kuwahara, C., K. Koyama and H. Sugiyama. Estimation of daily uranium ingestion by urban residents in Japan. *J Radioanal Nucl Chem* 220(2): 161-165 (1997).
- L1 L'Azou, B., M.H. Henge-Napoli, L. Minaro et al. Effects of cadmium and uranium on some in vitro renal targets. *Cell Biol Toxicol* 18(5): 329-340 (2002).
- L2 La Touche, Y.D., D.L. Willis and O.I. Dawydiak. Absorption and biokinetics of U in rats following an oral administration of uranyl nitrate solution. *Health Phys* 53(2): 147-162 (1987).
- L3 Labar, B., I. Rudan, D. Ivankovic et al. Haematological malignancies in childhood in Croatia: Investigating the theories of depleted uranium, chemical plant damage and 'population mixing'. *Eur J Epidemiol* 19(1): 55-60 (2004).
- L4 LaCerte, C., H. Xie, A.M. Aboueissa et al. Particulate depleted uranium is cytotoxic and clastogenic to human lung epithelial cells. *Mutat Res* 697(1-2): 33-37 (2010).

- L5 Lagorio, S., E. Grande and L. Martina. Review of epidemiological studies of cancer risk among Gulf War and Balkans veterans. *Epidemiol Prev* 32(3): 145-155 (2008). (Italian).
- L6 Landa, E.R. and T.B. Cuncell. Leaching of uranium from glass and ceramic foodware and decorative items. *Health Phys* 63(3): 343-348 (1992).
- L7 Lane, R., P. Thompson, M. Ilin et al. Use of a weight of evidence approach to determine the likelihood of adverse effects on human health from the presence of uranium facilities in Port Hope, Ontario. *J Environ Prot* 2(9): 1149-1161 (2011).
- L8 Lane, R.S., S.E. Frost, G.R. Howe et al. Mortality (1950-1999) and cancer incidence (1969-1999) in the cohort of Eldorado uranium workers. *Radiat Res* 174(6): 773-785 (2010).
- L9 Lang, S., V.M. Kosma, T. Kumlin et al. Distribution and short-term effects of intratracheally instilled neutron-irradiated UO<sub>2</sub> particles in the rat. *Environ Res* 65(1): 119-131 (1994).
- L10 Langmuir, D. Uranium solution-mineral equilibria at low temperatures with applications to sedimentary ore deposits. *Geochim Cosmochim Acta* 42(6): 547-569 (1978).
- L11 Lariviere, D., A.P. Packer, L. Marro et al. Age dependence of natural uranium and thorium concentrations in bone. *Health Phys* 92(2): 119-126 (2007).
- L12 Larivière, D., S.Y. Tolmachev, V. Kochermin et al. Uranium bone content as an indicator of chronic environmental exposure from drinking water. *J Environ Radioact* 121: 98-103 (2013).
- L13 Laurent, O., M. Gomolka, R. Haylock et al. Concerted Uranium Research in Europe (CURE): toward a collaborative project integrating dosimetry, epidemiology and radiobiology to study the effects of occupational uranium exposure. *J Radiol Prot* 36(2): 319-345 (2016).
- L14 Laurette, J., C. Larue, I. Llorens et al. Speciation of uranium in plants upon root accumulation and root-to-shoot translocation. *Environ Exp Bot* 77: 87-95 (2012).
- L15 Laurette, J., C. Larue, C. Mariet et al. Influence of uranium speciation on its accumulation and translocation in three plant species: oilseed rape, sunflower and wheat. *Environ Exp Bot* 77: 96-107 (2012).
- L16 Laurier, D., I. Guseva Canu, S. Baatout et al. DoReMi workshop on multidisciplinary approaches to evaluate cancer risks associated to low dose internal contamination. *Radioprotection* 47(1): 119-148 (2012).
- L17 Laurier, D. Progress in understanding radon risk. pp.65-89 in: *Radiation Protection No 168. EU Scientific Seminar 2010 'Issues with internal emitters'*. European Commission, Luxembourg, 2013.
- L18 Leach, L.J., C.L. Yuile, H.C. Hodge et al. A five year inhalation study with natural uranium dioxide (UO<sub>2</sub>) dust. II. Postexposure retention and biologic effects in the monkey, dog and rat. *Health Phys* 25(3): 239-258 (1973).
- L19 Leach, L.J., R.M. Gelein, B.J. Panner et al. The acute toxicity of the hydrolysis products of uranium hexafluoride (UF<sub>6</sub>) when inhaled by the rat and guinea pig. Final report. K/SUB-81-9039/3; NTIS DE84011539. Rochester University Medical Center, New York, 1984.
- L20 Lee, S.H., P.P. Povinec, E. Wyse et al. Ultra-low-level determination of <sup>236</sup>U in IAEA marine reference materials by ICPMS and AMS. *Appl Radiat Isot* 66(6-7): 823-828 (2008).
- L21 Leggett, R.W. The behavior and chemical toxicity of U in the kidney: a reassessment. *Health Phys* 57(3): 365-383 (1989).
- L22 Leggett, R.W. Basis for the ICRP's age-specific biokinetic model for uranium. *Health Phys* 67(6): 589-610 (1994).
- L23 Leggett, R.W. and J.D. Harrison. Fractional absorption of ingested uranium in humans. *Health Phys* 68(4): 484-498 (1995).

- L24 Leggett, R.W., K.F. Eckerman and J.D. Boice, Jr. A respiratory model for uranium aluminide based on occupational data. *J Radiol Prot* 25(4): 405-416 (2005).
- L25 Leggett, R.W., K.F. Eckerman, C.W. McGinn et al. Controlling intake of uranium in the workplace: applications of biokinetic modeling and occupational monitoring data. ORNL/TM-2012/14. Oak Ridge National Laboratory, TN, USA, 2012.
- L26 Legrand, M., C. Elie, J. Stefani et al. Cell proliferation and cell death are disturbed during prenatal and postnatal brain development after uranium exposure. *Neurotoxicology* 52: 34-45 (2016).
- L27 Lemercier, V., X. Millot, E. Ansoborlo et al. Study of uranium transfer across the blood-brain barrier. *Radiat Prot Dosim* 105(1-4): 243-245 (2003).
- L28 Leon Vintro, L., P.I. Mitchell, A. Omarova et al. Americium, plutonium and uranium contamination and speciation in well waters, streams and atomic lakes in the Sarzhal region of the Semipalatinsk Nuclear Test Site, Kazakhstan. *J Environ Radioact* 100(4): 308-314 (2009).
- L29 Lestaevel, P., C. Bussy, F. Paquet et al. Changes in sleep-wake cycle after chronic exposure to uranium in rats. *Neurotoxicol Teratol* 27(6): 835-840 (2005).
- L30 Lestaevel, P., P. Houpert, C. Bussy et al. The brain is a target organ after acute exposure to depleted uranium. *Toxicology* 212(2-3): 219-226 (2005).
- L31 Lestaevel, P., E. Romero, B. Dhieux et al. Different pattern of brain pro-/anti-oxidant activity between depleted and enriched uranium in chronically exposed rats. *Toxicology* 258(1): 1-9 (2009).
- L32 Lestaevel, P., H. Bensoussan, B. Dhieux et al. Cerebral cortex and hippocampus respond differently after post-natal exposure to uranium. *J Toxicol Sci* 38(5): 803-811 (2013).
- L33 Lestaevel, P., F. Airault, R. Racine et al. Influence of environmental enrichment and depleted uranium on behaviour, cholesterol and acetylcholine in apolipoprotein E-deficient mice. *J Mol Neurosci* 53(3): 469-479 (2014).
- L34 Li, W.B., Z. Karpas, L. Salonen et al. A compartmental model of uranium in human hair for protracted ingestion of natural uranium in drinking water. *Health Phys* 96(6): 636-645 (2009).
- L35 Lide, D.R. Uranium. pp.31–32 in: *Handbook of Chemistry and Physics*. CRC Press, Boca Raton, 1994.
- L36 Lin, R.H., L.J. Wu, C.H. Lee et al. Cytogenetic toxicity of uranyl nitrate in Chinese hamster ovary cells. *Mutat Res* 319(3): 197-203 (1993).
- L37 Linares, V., M.L. Albina, M. Belles et al. Combined action of uranium and stress in the rat. II. Effects on male reproduction. *Toxicol Lett* 158(3): 186-195 (2005).
- L38 Linares, V., D.J. Sanchez, M. Belles et al. Pro-oxidant effects in the brain of rats concurrently exposed to uranium and stress. *Toxicology* 236(1-2): 82-91 (2007).
- L39 Lind, O.C., B. Salbu, L. Skipperud et al. Solid state speciation and potential bioavailability of depleted uranium particles from Kosovo and Kuwait. *J Environ Radioact* 100(4): 301-307 (2009).
- L40 Lizon, C. and P. Fritsch. Chemical toxicity of some actinides and lanthanides towards alveolar macrophages: An in vitro study. *Int J Radiat Biol* 75(11): 1459-1471 (1999).
- L41 Llobet, J.M., J.J. Sirvent, A. Ortega et al. Influence of chronic exposure to uranium on male reproduction in mice. *Fundam Appl Toxicol* 16(4): 821-829 (1991).
- L42 Lloyd, D.C., J.N. Lucas, A.A. Edwards et al. A study to verify a reported excess of chromosomal aberrations in blood lymphocytes of Namibian uranium miners. *Radiat Res* 155(6): 809-817 (2001).
- L43 LNHB. Mini table de Radionucléides. Laboratoire National Henri Becquerel, EDP Sciences, 2007. (French).

- L44 Loomis, D.P. and S.H. Wolf. Mortality of workers at a nuclear materials production plant at Oak Ridge, Tennessee, 1947-1990. *Am J Ind Med* 29(2): 131-141 (1996).
- L45 Lopez-Abente, G., N. Aragonés, M. Pollán et al. Leukemia, lymphomas, and myeloma mortality in the vicinity of nuclear power plants and nuclear fuel facilities in Spain. *Cancer Epidemiol Biomarkers Prev* 8(10): 925-934 (1999).
- L46 Lopez-Abente, G., N. Aragonés and M. Pollán. Solid-tumor mortality in the vicinity of uranium cycle facilities and nuclear power plants in Spain. *Environ Health Perspect* 109(7): 721-729 (2001).
- L47 Lopez, R., P.L. Diaz Sylvester, A.M. Ubios et al. Percutaneous toxicity of uranyl nitrate: its effect in terms of exposure area and time. *Health Phys* 78(4): 434-437 (2000).
- L48 Lu, S. and F.Y. Zhao. Nephrotoxic limit and annual limit on intake for natural U. *Health Phys* 58(5): 619-623 (1990).
- L49 Lucas, H.F. and F. Markun. Thorium and uranium in blood, urine and cigarettes. pp.47-52 in: ANL-7760. Argonne National Laboratory Radiation Physics Division Annual Report, Part 2. Argonne National Laboratory, Argonne, 1970.
- L50 Lytle, D.A., T. Sorg, L. Wang et al. The accumulation of radioactive contaminants in drinking water distribution systems. *Water Res* 50: 396-407 (2014).
- M1 Macfarlane, G.J., A.M. Biggs, N. Maconochie et al. Incidence of cancer among UK Gulf war veterans: cohort study. *Br Med J* 327(7428): 1373 (2003).
- M2 Macfarlane, G.J., M. Hotopf, N. Maconochie et al. Long-term mortality amongst Gulf War Veterans: is there a relationship with experiences during deployment and subsequent morbidity? *Int J Epidemiol* 34(6): 1403-1408 (2005).
- M3 MacNider, W.D. A consideration of the relative toxicity of uranium nitrate for animals of different ages. I. *J Exp Med* 26(1): 1-17 (1917).
- M4 Maeng, H.J., W.S. Shim, S.J. Ahn et al. Differential changes in functional activity of organic cation transporters in rats with uranyl nitrate-induced acute renal failure. *Arch Pharm Res* 35(8): 1441-1448 (2012).
- M5 Magdo, H.S., J. Forman, N. Graber et al. Grand rounds: nephrotoxicity in a young child exposed to uranium from contaminated well water. *Environ Health Perspect* 115(8): 1237-1241 (2007).
- M6 Malard, V., O. Prat, E. Darrouzet et al. Proteomic analysis of the response of human lung cells to uranium. *Proteomics* 5(17): 4568-4580 (2005).
- M7 Malatova, I., V. Beckova, L. Tomasek et al. Reassessment of individual dosimetry of long-lived alpha radionuclides of uranium miners through experimental determination of urinary excretion of uranium. *Radiat Prot Dosim* 154(2): 198-206 (2013).
- M8 Malatova, I., V. Beckova and L. Kotik. Urinary excretion of uranium in adult inhabitants of the Czech Republic. *J Environ Radioact* 152: 92-96 (2016).
- M9 Mao, Y., M. Desmeules, D. Schaubel et al. Inorganic components of drinking water and microalbuminuria. *Environ Res* 71(2): 135-140 (1995).
- M10 Marsh, J.W., Y. Bessa, A. Birchall et al. Dosimetric models used in the Alpha-Risk project to quantify exposure of uranium miners to radon gas and its progeny. *Radiat Prot Dosim* 130(1): 101-106 (2008).
- M11 Marsh, J.W., E. Blanchardon, D. Gregoratto et al. Dosimetric calculations for uranium miners for epidemiological studies. *Radiat Prot Dosim* 149(4): 371-383 (2012).

- M12 Marsh, J.W., J.D. Harrison, D. Laurier et al. Doses and lung cancer risks from exposure to radon and plutonium. *Int J Radiat Biol* 90(11): 1080-1087 (2014).
- M13 Martin, F., R. Earl and E.J. Tawn. A cytogenetic study of men occupationally exposed to uranium. *Br J Ind Med* 48(2): 98-102 (1991).
- M14 Martín Sánchez, A., M.P. Rubio Montero, V. Gómez Escobar et al. Radioactivity in bottled mineral waters. *Appl Radiat Isot* 50(6): 1049-1055 (1999).
- M15 Matsuba, M., T. Ishii, M. Nakahara et al. The concentrations of uranium in marine organisms. *Radioisotopes* 49(7): 346-353 (2000).
- M16 Maynard, E.A. and H.C. Hodge. Studies of the toxicity of various uranium compounds when fed to experimental animals. pp.309-376 in: *The Pharmacology and Toxicology of Uranium Compounds*, First edition (C. Voegtlin and H.C. Hodge, eds.). McGraw-Hill, New York, 1949.
- M17 McClain, D.E., K.A. Benson, T.K. Dalton et al. Biological effects of embedded depleted uranium (DU): summary of armed forces radiobiology research institute research. *Sci Total Environ* 274(1-3): 115-118 (2001).
- M18 McConnell, M.A., V.M. Sadagopa Ramanujam, N.W. Alcock et al. Distribution of uranium-238 in environmental samples from a residential area impacted by mining and milling activities. *Environ Toxicol Chem* 17(5): 841-850 (1998).
- M19 McDiarmid, M.A., J.P. Keogh, F.J. Hooper et al. Health effects of depleted uranium on exposed Gulf War veterans. *Environ Res* 82(2): 168-180 (2000).
- M20 McDiarmid, M.A., S. Engelhardt, M. Oliver et al. Health effects of depleted uranium on exposed Gulf War veterans: a 10-year follow-up. *J Toxicol Environ Health A* 67(4): 277-296 (2004).
- M21 McDiarmid, M.A., S.M. Engelhardt, M. Oliver et al. Biological monitoring and surveillance results of Gulf War I veterans exposed to depleted uranium. *Int Arch Occup Environ Health* 79(1): 11-21 (2006).
- M22 McDiarmid, M.A., S.M. Engelhardt, M. Oliver et al. Health surveillance of Gulf War I veterans exposed to depleted uranium: updating the cohort. *Health Phys* 93(1): 60-73 (2007).
- M23 McDiarmid, M.A., S.M. Engelhardt, C.D. Dorsey et al. Surveillance results of depleted uranium-exposed Gulf War I veterans: sixteen years of follow-up. *J Toxicol Environ Health A* 72(1): 14-29 (2009).
- M24 McDiarmid, M.A., R.J. Albertini, J.D. Tucker et al. Measures of genotoxicity in Gulf War I veterans exposed to depleted uranium. *Environ Mol Mutagen* 52(7): 569-581 (2011).
- M25 McDiarmid, M.A., J.M. Gaitens, S. Hines et al. The Gulf War depleted uranium cohort at 20 years: bioassay results and novel approaches to fragment surveillance. *Health Phys* 104(4): 347-361 (2013).
- M26 McGeoghegan, D. and K. Binks. The mortality and cancer morbidity experience of workers at the Capenhurst uranium enrichment facility 1946-95. *J Radiol Prot* 20(4): 381-401 (2000).
- M27 McGeoghegan, D. and K. Binks. The mortality and cancer morbidity experience of workers at the Springfields uranium production facility, 1946-95. *J Radiol Prot* 20(2): 111-137 (2000).
- M28 McGeoghegan, D. and K. Binks. The mortality and cancer morbidity experience of employees at the Chapelcross plant of British Nuclear Fuels plc, 1955-95. *J Radiol Prot* 21(3): 221-250 (2001).
- M29 McGeoghegan, D., K. Binks, M. Gillies et al. The non-cancer mortality experience of male workers at British Nuclear Fuels plc, 1946-2005. *Int J Epidemiol* 37(3): 506-518 (2008).

- M30 McGeoghegan, D., S. Whaley, K. Binks et al. Mortality and cancer registration experience of the Sellafield workers known to have been involved in the 1957 Windscale accident: 50 year follow-up. *J Radiol Prot* 30(3): 407-431 (2010).
- M31 Meija, J., T.B. Coplen, M. Berglund et al. Atomic weights of the elements 2013 (IUPAC technical report). *Pure Appl Chem* 88(3): 265-291 (2016).
- M32 Meija, J., T.B. Coplen, M. Berglund et al. Isotopic compositions of the elements 2013 (IUPAC technical report). *Pure Appl Chem* 88(3): 293-306 (2016).
- M33 Meszaros, G., G. Bognar and G.J. Koteles. Long-term persistence of chromosome aberrations in uranium miners. *J Occup Health* 46(4): 310-315 (2004).
- M34 Michard, A., C. Beaucaire and G. Michard. Uranium and rare earth elements in CO<sub>2</sub>-rich waters from Vals-les-Bains (France)\*. *Geochim Cosmochim Acta* 51(4): 901-909 (1987).
- M35 Milacic, S., D. Petrovic, D. Jovicic et al. Examination of the health status of populations from depleted-uranium-contaminated regions. *Environ Res* 95(1): 2-10 (2004).
- M36 Milacic, S. Health investigations of depleted-uranium clean-up workers. *Med Lav* 99(5): 366-370 (2008).
- M37 Milgram, S., M. Carriere, L. Malaval et al. Cellular accumulation and distribution of uranium and lead in osteoblastic cells as a function of their speciation. *Toxicology* 252(1-3): 26-32 (2008).
- M38 Milgram, S., M. Carriere, C. Thiebault et al. Cytotoxic and phenotypic effects of uranium and lead on osteoblastic cells are highly dependent on metal speciation. *Toxicology* 250(1): 62-69 (2008).
- M39 Miller, A.C., W.F. Blakely, D. Livengood et al. Transformation of human osteoblast cells to the tumorigenic phenotype by depleted uranium-uranyl chloride. *Environ Health Perspect* 106(8): 465-471 (1998).
- M40 Miller, A.C., M. Stewart, K. Brooks et al. Depleted uranium-catalyzed oxidative DNA damage: absence of significant alpha particle decay. *J Inorg Biochem* 91(1): 246-252 (2002).
- M41 Miller, A.C., J. Xu, M. Stewart et al. Potential late health effects of depleted uranium and tungsten used in armor-piercing munitions: comparison of neoplastic transformation and genotoxicity with the known carcinogen nickel. *Mil Med* 167(2 Suppl): 120-122 (2002).
- M42 Miller, A.C., K. Brooks, M. Stewart et al. Genomic instability in human osteoblast cells after exposure to depleted uranium: delayed lethality and micronuclei formation. *J Environ Radioact* 64(2-3): 247-259 (2003).
- M43 Miller, A.C., K. Brooks, J. Smith et al. Effect of the militarily-relevant heavy metals, depleted uranium and heavy metal tungsten-alloy on gene expression in human liver carcinoma cells (HepG2). *Mol Cell Biochem* 255(1-2): 247-256 (2004).
- M44 Miller, A.C., C. Bonait-Pellie, R.F. Merlot et al. Leukemic transformation of hematopoietic cells in mice internally exposed to depleted uranium. *Mol Cell Biochem* 279(1-2): 97-104 (2005).
- M45 Miller, A.C., M. Stewart and R. Rivas. Preconceptional paternal exposure to depleted uranium: Transmission of genetic damage to offspring. *Health Phys* 99(3): 371-379 (2010).
- M46 Mirderikvand, N., B. Mohammadzadeh Asl, P. Naserzadeh et al. Embryo toxic effects of depleted uranium on the morphology of the mouse fetus. *Iran J Pharm Res* 13(1): 199-206 (2014).
- M47 Mirto, H., M.H. Henge-Napoli, R. Gibert et al. Intracellular behaviour of uranium(VI) on renal epithelial cell in culture (LLC-PK1): influence of uranium speciation. *Toxicol Lett* 104(3): 249-256 (1999).



- M48 Misdaq, M.A. and A. Chaouqi.  $^{238}\text{U}$ ,  $^{232}\text{Th}$ ,  $^{222}\text{Rn}$ , and  $^{220}\text{Rn}$  concentrations measured in various bottled mineral waters and resulting radiation doses to the members of the European population living in the City of Marrakech (Morocco). *Health Phys* 94(3): 279-291 (2008).
- M49 Mitchel, R.E.J., J.S. Jackson and B. Heinmiller. Inhaled uranium ore dust and lung cancer risk in rats. *Health Phys* 76(2): 145-155 (1999).
- M50 Mohner, M., M. Lindtner, H. Otten et al. Leukemia and exposure to ionizing radiation among German uranium miners. *Am J Ind Med* 49(4): 238-248 (2006).
- M51 Mohner, M., M. Lindtner and H. Otten. Ionizing radiation and risk of laryngeal cancer among German uranium miners. *Health Phys* 95(6): 725-733 (2008).
- M52 Mohner, M., J. Gellissen, J.W. Marsh et al. Occupational and diagnostic exposure to ionizing radiation and leukemia risk among German uranium miners. *Health Phys* 99(3): 314-321 (2010).
- M53 Mollegaard, N.E., A.I. Murchie, D.M. Lilley et al. Uranyl photoprobing of a four-way DNA junction: evidence for specific metal ion binding. *EMBO J* 13(7): 1508-1513 (1994).
- M54 Monleau, M., C. Bussy, P. Lestaevel et al. Bioaccumulation and behavioural effects of depleted uranium in rats exposed to repeated inhalations. *Neurosci Lett* 390(1): 31-36 (2005).
- M55 Monleau, M., M. De Meo, S. Frelon et al. Distribution and genotoxic effects after successive exposure to different uranium oxide particles inhaled by rats. *Inhal Toxicol* 18(11): 885-894 (2006).
- M56 Monleau, M., M. De Meo, F. Paquet et al. Genotoxic and inflammatory effects of depleted uranium particles inhaled by rats. *Toxicol Sci* 89(1): 287-295 (2006).
- M57 Moon, Y.J., A.K. Lee, H.C. Chung et al. Effects of acute renal failure on the pharmacokinetics of chlorzoxazone in rats. *Drug Metab Dispos* 31(6): 776-784 (2003).
- M58 Moore, J., M. Limson-Zamora, L. Whiteduck et al. Elevated uranium levels in groundwater and the potential bioeffects. Presented at the 7th National Conference on Drinking Water, Charlottetown, 10-13 August 1996.
- M59 Morris, K.J., K.M. Townsend and A.L. Batchelor. Studies of alveolar cell morphometry and mass clearance in the rat lung following inhalation of an enriched uranium dioxide aerosol. *Radiat Environ Biophys* 28(2): 141-154 (1989).
- M60 Morris, K.J., P. Khanna and A.L. Batchelor. Long-term clearance of inhaled  $\text{UO}_2$  particles from the pulmonary region of the rat. *Health Phys* 58(4): 477-485 (1990).
- M61 Morris, K.J., C.L. Barker, A.L. Batchelor et al. Dosimetric implications of pulmonary macrophage clusters observed within lungs of rats that have inhaled enriched  $\text{UO}_2$  particles. *Environ Health Perspect* 97: 201-208 (1992).
- M62 Morrow, P., R. Gelein, H. Beiter et al. Inhalation and intravenous studies of  $\text{UF}_6/\text{UO}_2\text{F}_2$  in dogs. *Health Phys* 43(6): 859-873 (1982).
- M63 Morrow, P.E., L.J. Leach, F.A. Smith et al. Metabolic fate and evaluation of injury in rats and dogs following exposure to the hydrolysis products of uranium hexafluoride: implications for a bioassay program related to potential releases of uranium hexafluoride, July 1979-October 1981. NUREG/CR-2268. U.S. Nuclear Regulatory Commission, Washington, D.C., 1982.
- M64 Moss, M.A., R.F. McCurdy, K.C. Dooley et al. Uranium in drinking water - report on clinical studies in Nova Scotia. pp.149-152 in: *Chemical Toxicology and Clinical Chemistry of Metals* (S.S. Brown and J. Savory, eds.). Academic Press, London, 1983.
- M65 Moss, M.A. Chronic low level uranium exposure via drinking water - clinical investigations in Nova Scotia. M.Sc. Thesis, Dalhousie University, Halifax (1985).

- M66 Muikku, M., T. Heikkinen, M. Puhakainen et al. Assessment of occupational exposure to uranium by indirect methods needs information on natural background variations. *Radiat Prot Dosim* 125(1-4): 492-495 (2007).
- M67 Muikku, M., M. Puhakainen, T. Heikkinen et al. The mean concentration of uranium in drinking water, urine, and hair of the occupationally unexposed Finnish working population. *Health Phys* 96(6): 646-654 (2009).
- M68 Muller, D., P. Houpert, J. Cambar et al. Role of the sodium-dependent phosphate co-transporters and of the phosphate complexes of uranyl in the cytotoxicity of uranium in LLC-PK1 cells. *Toxicol Appl Pharmacol* 214(2): 166-177 (2006).
- M69 Muller, D.S., P. Houpert, J. Cambar et al. Role of the sodium-dependent phosphate cotransporters and absorptive endocytosis in the uptake of low concentrations of uranium and its toxicity at higher concentrations in LLC-PK1 cells. *Toxicol Sci* 101(2): 254-262 (2008).
- M70 Muller, W.U., A. Kryscio and C. Streffer. Micronuclei in lymphocytes of uranium miners of the former Wismut SDAG. *Cytogenet Genome Res* 104(1-4): 295-298 (2004).
- N1 National Research Council Committee on Health Risks of Exposure to Radon. *Health Effects of Exposure to Radon: BEIR VI*. National Academies Press, Washington, D.C., 1999.
- N2 NCRP. Exposure of the population in the United States and Canada from natural background radiation. NCRP Report No. 94. National Council on Radiation Protection and Measurements, Bethesda, 1988.
- N3 NCRP. Development of a biokinetic model for radionuclide contaminated wounds and procedures for their assessment, dosimetry and treatment. NCRP Report No. 156. National Council on Radiation Protection and Measurements, Bethesda, 2006.
- N4 Newey, H., P.A. Sanford and D.H. Smyth. The effect of uranyl nitrate on intestinal transfer of hexoses. *J Physiol* 186(3): 493-502 (1966).
- N5 NHMRC and NRMCC. Australian drinking water guidelines paper 6. National water quality management strategy. National Health and Medical Research Council, National Resource Management Ministerial Council, Commonwealth of Canberra, Australia, 2011.
- N6 Nicklas, J.A., R.J. Albertini, P.M. Vacek et al. Mutagenicity monitoring following battlefield exposures: Molecular analysis of HPRT mutations in Gulf War I veterans exposed to depleted uranium. *Environ Mol Mutagen* 56(7): 594-608 (2015).
- N7 Nielsen, P.E., N.E. Mollegaard and C. Jeppesen. DNA conformational analysis in solution by uranyl mediated photocleavage. *Nucleic Acids Res* 18(13): 3847-3851 (1990).
- N8 NNDC. Chart of nuclides. National Nuclear Data Center. [Internet] Available from (<http://www.nndc.bnl.gov/chart/>) on 12.03.2014.
- N9 Nozaki, T., M. Ichikawa, T. Sasuga et al. Neutron activation analysis of uranium in human bone, drinking water and daily diet. *J Radioanal Chem* 6(1): 33-40 (1970).
- O1 Oeh, U., N.D. Priest, P. Roth et al. Measurements of daily urinary uranium excretion in German peacekeeping personnel and residents of the Kosovo region to assess potential intakes of depleted uranium (DU). *Sci Total Environ* 381(1-3): 77-87 (2007).
- O2 Okogbue, C.O. and S.N. Ukpai. Evaluation of trace element contents in groundwater in Abakaliki metropolis and around the abandoned mine sites in the southern part, Southeastern Nigeria. *Environ Earth Sci* 70(7): 3351-3362 (2013).
- O3 OME. Rationale for development of Ontario air standards for uranium and uranium compounds. Standards Development Branch, Ontario Ministry of Environment, 2009.

- O4 Orcutt, J.A. The toxicology of compounds of uranium following application to the skin. Chapter VIII in: *Pharmacology and Toxicology of Uranium Compounds* (J.A. Orcutt, ed.). McGraw-Hill, New York, 1949.
- O5 Orloff, K.G., K. Mistry, P. Charp et al. Human exposure to uranium in groundwater. *Environ Res* 94(3): 319-326 (2004).
- O6 Orona, N.S. and D.R. Tasat. Uranyl nitrate-exposed rat alveolar macrophages cell death: Influence of superoxide anion and TNF  $\alpha$  mediators. *Toxicol Appl Pharmacol* 261(3): 309-316 (2012).
- O7 Ortega, A., J.L. Domingo, J.M. Llobet et al. Evaluation of the oral toxicity of uranium in a 4-week drinking-water study in rats. *Bull Environ Contam Toxicol* 42(6): 935-941 (1989).
- O8 Ortega, X., I. Vallés and I. Serrano. Natural radioactivity in drinking water in Catalonia (Spain). *Environ Int* 22(Suppl 1): 347-354 (1996).
- O9 Osmond, J.K., J.B. Cowart and M. Ivanovich. Uranium isotopic disequilibrium in ground water as an indicator of anomalies. *Int J Appl Radiat Isot* 34(1): 283-308 (1983).
- O10 Ozkaynak, H., J. Xue, V.G. Zartarian et al. Modeled estimates of soil and dust ingestion rates for children. *Risk Anal* 31(4): 592-608 (2011).
- O11 Ozmen, M. and M. Yurekli. Subacute toxicity of uranyl acetate in Swiss-Albino mice. *Environ Toxicol Pharmacol* 6(2): 111-115 (1998).
- P1 Palazzuoli, A., S. Masson, C. Ronco et al. Clinical relevance of biomarkers in heart failure and cardiorenal syndrome: the role of natriuretic peptides and troponin. *Heart Fail Rev* 19(2): 267-284 (2014).
- P2 Pan, Z. and S. Liu. *Radiation Level in China*. China Atomic Energy Publishing and Media Co., Ltd., 2011.
- P3 Paquet, F., P. Houpert, E. Blanchardon et al. Accumulation and distribution of uranium in rats after chronic exposure by ingestion. *Health Phys* 90(2): 139-147 (2006).
- P4 Paquet, F., G. Etherington, M.R. Bailey et al. ICRP Publication 130: Occupational intakes of radionuclides: Part 1. *Ann ICRP* 44(2): 5-188 (2015).
- P5 Parrish, R.R., M. Horstwood, J.G. Arnason et al. Depleted uranium contamination by inhalation exposure and its detection after  $\sim$  20 years: Implications for human health assessment. *Sci Total Environ* 390(1): 58-68 (2008).
- P6 Pasanen, M., S. Lang, A. Kojo et al. Effects of simulated nuclear fuel particles on the histopathology and CYP enzymes in the rat lung and liver. *Environ Res* 70(2): 126-133 (1995).
- P7 Paternain, J.L., J.L. Domingo, A. Ortega et al. The effects of uranium on reproduction, gestation, and postnatal survival in mice. *Ecotoxicol Environ Saf* 17(3): 291-296 (1989).
- P8 Patra, A.C., S. Mohapatra, S.K. Sahoo et al. Age-dependent dose and health risk due to intake of uranium in drinking water from Jaduguda, India. *Radiat Prot Dosim* 155(2): 210-216 (2013).
- P9 Pavlakis, N., C.A. Pollock, G. McLean et al. Deliberate overdose of uranium: toxicity and treatment. *Nephron* 72(2): 313-317 (1996).
- P10 Pelayo, J.C., P.M. Andrews, A.K. Coffey et al. The influence of age on acute renal toxicity of uranyl nitrate in the dog. *Pediatr Res* 17(12): 985-992 (1983).
- P11 Pellmar, T.C., A.F. Fuciarelli, J.W. Ejniak et al. Distribution of uranium in rats implanted with depleted uranium pellets. *Toxicol Sci* 49(1): 29-39 (1999).

- P12 Pellmar, T.C., D.O. Keyser, C. Emery et al. Electrophysiological changes in hippocampal slices isolated from rats embedded with depleted uranium fragments. *Neurotoxicology* 20(5): 785-792 (1999).
- P13 Periyakaruppan, A., F. Kumar, S. Sarkar et al. Uranium induces oxidative stress in lung epithelial cells. *Arch Toxicol* 81(6): 389-395 (2007).
- P14 Pernot, E., J. Hall, S. Baatout et al. Ionizing radiation biomarkers for potential use in epidemiological studies. *Mutat Res* 751(2): 258-286 (2012).
- P15 Petitot, F., A.M. Moreels and F. Paquet. In vitro evaluation of percutaneous diffusion of uranyl nitrate through intact or excoriated skin of rat and pig. *Can J Physiol Pharmacol* 82(2): 133-139 (2004).
- P16 Petitot, F., S. Frelon, A.M. Moreels et al. Incorporation and distribution of uranium in rats after a contamination on intact or wounded skin. *Health Phys* 92(5): 464-474 (2007).
- P17 Petitot, F., C. Gautier, A.M. Moreels et al. Percutaneous penetration of uranium in rats after a contamination on intact or wounded skin. *Radiat Prot Dosim* 127(1-4): 125-130 (2007).
- P18 Petitot, F., P. Lestaevel, E. Tournalias et al. Inhalation of uranium nanoparticles: respiratory tract deposition and translocation to secondary target organs in rats. *Toxicol Lett* 217(3): 217-225 (2013).
- P19 Pietrzak-Flis, Z., M.M. Suplinska and L. Rosiak. The dietary intake of  $^{238}\text{U}$ ,  $^{234}\text{U}$ ,  $^{230}\text{Th}$ ,  $^{232}\text{Th}$ ,  $^{228}\text{Th}$  and  $^{226}\text{Ra}$  from food and drinking water by inhabitants of the Wallbrzych region. *J Radioanal Nucl Chem* 222(1-2): 189-193 (1997).
- P20 Pietrzak-Flis, Z., L. Rosiak, M.M. Suplinska et al. Daily intakes of  $^{238}\text{U}$ ,  $^{234}\text{U}$ ,  $^{232}\text{Th}$ ,  $^{230}\text{Th}$ ,  $^{228}\text{Th}$  and  $^{226}\text{Ra}$  in the adult population of central Poland. *Sci Total Environ* 273(1-3): 163-169 (2001).
- P21 Pinkerton, L.E., T.F. Bloom, M.J. Hein et al. Mortality among a cohort of uranium mill workers: an update. *Occup Environ Med* 61(1): 57-64 (2004).
- P22 Pinney, S.M., R.W. Freyberg, G.E. Levine et al. Health effects in community residents near a uranium plant at Fernald, Ohio, USA. *Int J Occup Med Environ Health* 16(2): 139-153 (2003).
- P23 Poisson, C., J. Stefani, L. Manens et al. Chronic uranium exposure dose-dependently induces glutathione in rats without any nephrotoxicity. *Free Radic Res* 48(10): 1218-1231 (2014).
- P24 Polednak, A.P. and E.L. Frome. Mortality among men employed between 1943 and 1947 at a uranium-processing plant. *J Occup Med* 23(3): 169-178 (1981).
- P25 Popp, W., U. Plappert, W.U. Muller et al. Biomarkers of genetic damage and inflammation in blood and bronchoalveolar lavage fluid among former German uranium miners: a pilot study. *Radiat Environ Biophys* 39(4): 275-282 (2000).
- P26 Pourahmad, J., M. Ghashang, H.A. Ettehadi et al. A search for cellular and molecular mechanisms involved in depleted uranium (DU) toxicity. *Environ Toxicol* 21(4): 349-354 (2006).
- P27 Prat, O., F. Berenguer, V. Malard et al. Transcriptomic and proteomic responses of human renal HEK293 cells to uranium toxicity. *Proteomics* 5(1): 297-306 (2005).
- P28 Prat, O., T. Vercoouter, E. Ansoborlo et al. Uranium speciation in drinking water from drilled wells in southern Finland and its potential links to health effects. *Environ Sci Technol* 43(10): 3941-3946 (2009).
- P29 Prat, O., F. Berenguer, G. Steinmetz et al. Alterations in gene expression in cultured human cells after acute exposure to uranium salt: Involvement of a mineralization regulator. *Toxicol In Vitro* 24(1): 160-168 (2010).
- P30 Prat, O., E. Ansoborlo, N. Sage et al. From cell to man: evaluation of osteopontin as a possible biomarker of uranium exposure. *Environ Int* 37(4): 657-662 (2011).

- P31 Priest, N.D., G.R. Howells, D. Green et al. Uranium in bone: metabolic and autoradiographic studies in the rat. *Hum Toxicol* 1(2): 97-114 (1982).
- P32 Province of British Columbia. Variations in uranium and radioactivity levels in surface and ground water at selected sites in British Columbia, April 1980-March 1981. Ministry of Energy, Mines and Petroleum Resources and Ministry of Health, British Columbia, Victoria, 1981.
- P33 Pujadas Bigi, M.M., L. Lemlich, P.M. Mandalunis et al. Exposure to oral uranyl nitrate delays tooth eruption and development. *Health Phys* 84(2): 163-169 (2003).
- P34 Pujadas Bigi, M.M. and A.M. Ubios. Catch-up of delayed tooth eruption associated with uranium intoxication. *Health Phys* 92(4): 345-348 (2007).
- Q1 Qi, L., C. Basset, O. Averseng et al. Characterization of  $UO_2^{2+}$  binding to osteopontin, a highly phosphorylated protein: Insights into potential mechanisms of uranyl accumulation in bones. *Metallomics* 6(1): 166-176 (2014).
- Q2 Qin, S., S. Li and et al. Concentration factors of  $^{90}Sr$ ,  $^{137}Cs$ ,  $^{210}Po$ , natural uranium and  $^{226}Ra$ , radionuclides in aquatic organisms in freshwater environment. *Fushe Fanghu* 15(5): 330-337 (1995). (Chinese).
- R1 Racine, R., Y. Gueguen, P. Gourmelon et al. Modifications of the expression of genes involved in cerebral cholesterol metabolism in the rat following chronic ingestion of depleted uranium. *J Mol Neurosci* 38(2): 159-165 (2009).
- R2 Racine, R., L. Grandcolas, S. Grison et al. Cholesterol 7 $\alpha$ -hydroxylase (CYP7A1) activity is modified after chronic ingestion of depleted uranium in the rat. *J Steroid Biochem Mol Biol* 120(1): 60-66 (2010).
- R3 Radespiel-Tröger, M. and M. Meyer. Association between drinking water uranium content and cancer risk in Bavaria, Germany. *Int Arch Occup Environ Health* 86(7): 767-776 (2013).
- R4 Rage, E., B. Vacquier, E. Blanchardon et al. Risk of lung cancer mortality in relation to lung doses among French uranium miners: follow-up 1956-1999. *Radiat Res* 177(3): 288-297 (2012).
- R5 Rage, E., S. Caer-Lorho, D. Drubay et al. Mortality analyses in the updated French cohort of uranium miners (1946-2007). *Int Arch Occup Environ Health* 20: 20 (2014).
- R6 Ramon Ramirez, J., P. Enriquez, R. Castillo et al. MOX fuel use in a BWR with extended power up-rate. *Ann Nucl Energy* 50: 63-70 (2012).
- R7 Rana, B.K., R.M. Tripathi, S.K. Sahoo et al. Assessment of natural uranium and  $^{226}Ra$  concentration in ground water around the uranium mine at Narwapahar, Jharkhand, India and its radiological significance. *J Radioanal Nucl Chem* 285(3): 711-717 (2010).
- R8 Rani, A., S. Singh, V. Duggal et al. Uranium estimation in drinking water samples from some areas of punjab and Himachal Pradesh, India using ICP-MS. *Radiat Prot Dosim* 157(1): 146-151 (2013).
- R9 Raymond-Whish, S., L.P. Mayer, T. O'Neal et al. Drinking water with uranium below the U.S. EPA water standard causes estrogen receptor-dependent responses in female mice. *Environ Health Perspect* 115(12): 1711-1716 (2007).
- R10 Reimann, C., K. Bjorvatn, B. Frengstad et al. Drinking water quality in the Ethiopian section of the East African Rift Valley I--data and health aspects. *Sci Total Environ* 311(1-3): 65-80 (2003).
- R11 Renaud, P. Doses liées à l'incorporation de radionucléides naturels par l'alimentation en France métropolitaine. PRP-ENV-SESURE/2014-18. Rapport Pôle Radioprotection, Environnement, Déchets et Crise, Service d'étude et de surveillance de la radioactivité dans l'environnement, 2014. (French).
- R12 Richardson, D.B. and S. Wing. Lung cancer mortality among workers at a nuclear materials fabrication plant. *Am J Ind Med* 49(2): 102-111 (2006).

- R13 Richardson, G.M. and Stantec Consulting Ltd. 2013 Canadian exposure factors handbook. Toxicology Centre, University of Saskatchewan, Saskatoon, SK Canada, 2013.
- R14 Ritz, B. Radiation exposure and cancer mortality in uranium processing workers. *Epidemiology* 10(5): 531-538 (1999).
- R15 Ritz, B. Cancer mortality among workers exposed to chemicals during uranium processing. *J Occup Environ Med* 41(7): 556-566 (1999).
- R16 Ritz, B., H. Morgenstern, D. Crawford-Brown et al. The effects of internal radiation exposure on cancer mortality in nuclear workers at Rocketdyne/Atomics International. *Environ Health Perspect* 108(8): 743-751 (2000).
- R17 Robertson, R. and D.C. Stuart. Physical characteristics and solubility of long-lived airborne particulates in uranium producing and manufacturing facilities; Phase IV-Part III. INFO-0363-9. Atomic Energy Control Board, Ottawa, Canada, 1995.
- R18 Rodrigues, G., J.D. Arruda-Neto, R.M. Pereira et al. Uranium deposition in bones of Wistar rats associated with skeleton development. *Appl Radiat Isot* 82: 1056110 (2013).
- R19 Rodriguez-Yoldi, M.J. and F. Ponz. Uranyl action on sugar transport across rat jejunum. *Rev Esp Fisiol* 42(3): 359-364 (1986).
- R20 Roessler, C.E., Z.A. Smith, W.E. Bolch et al. Uranium and radium-226 in Florida phosphate materials. *Health Phys* 37(3): 269-277 (1979).
- R21 Ronco, C., C.Y. Chionh, M. Haapio et al. The cardiorenal syndrome. *Blood Purif* 27(1): 114-126 (2009).
- R22 Rooney, C., V. Beral, N. Maconochie et al. Case-control study of prostatic cancer in employees of the United Kingdom Atomic Energy Authority. *Br Med J* 307(6916): 1391-1397 (1993).
- R23 Rossiter, H.M., P.A. Owusu, E. Awuah et al. Chemical drinking water quality in Ghana: water costs and scope for advanced treatment. *Sci Total Environ* 408(11): 2378-2386 (2010).
- R24 Roszell, L.E., F.F. Hahn, R.B. Lee et al. Assessing the renal toxicity of Capstone depleted uranium oxides and other uranium compounds. *Health Phys* 96(3): 343-351 (2009).
- R25 Rouas, C., M. Souidi, L. Grandcolas et al. Acetaminophen induces xenobiotic-metabolizing enzymes in rat: Impact of a uranium chronic exposure. *Environ Toxicol Pharmacol* 28(3): 363-369 (2009).
- R26 Rouas, C., H. Bensoussan, D. Suhard et al. Distribution of soluble uranium in the nuclear cell compartment at subtoxic concentrations. *Chem Res Toxicol* 23(12): 1883-1889 (2010).
- R27 Rouas, C., J. Stefani, S. Grison et al. Effect of nephrotoxic treatment with gentamicin on rats chronically exposed to uranium. *Toxicology* 279(1-3): 27-35 (2011).
- R28 Royal Society. The health hazards of depleted uranium munitions. Part II. The Royal Society, London, 2002.
- R29 Rožmarić, M., M. Rogić, L. Benedik et al. Natural radionuclides in bottled drinking waters produced in Croatia and their contribution to radiation dose. *Sci Total Environ* 437: 53-60 (2012).
- R30 Rusconi, R., M. Forte, G. Abbate et al. Natural radioactivity in bottled mineral waters: A survey in Northern Italy. *J Radioanal Nucl Chem* 260(2): 421-427 (2004).
- R31 Russell, J.J. and R.L. Kathren. Uranium deposition and retention in a USTUR whole body case. *Health Phys* 86(3): 273-284 (2004).
- S1 Samaropoulos, I., M. Efstathiou, I. Pashalidis et al. Determination of uranium concentration in ground water samples of Northern Greece. *EPJ Web of Conferences* 24(03005): 2012.

- S2 Sansone, U., L. Stellato, G. Jia et al. Levels of depleted uranium in Kosovo soils. *Radiat Prot Dosim* 97(4): 317-320 (2001).
- S3 Santos, E.E., D.C. Lauria, E.C.S. Amaral et al. Daily ingestion of  $^{232}\text{Th}$ ,  $^{238}\text{U}$ ,  $^{226}\text{Ra}$ ,  $^{228}\text{Ra}$  and  $^{210}\text{Pb}$  in vegetables by inhabitants of Rio de Janeiro City. *J Environ Radioact* 62(1): 75-86 (2002).
- S4 Schnell, H. Uranium processing practices, innovations, and trends. pp.457-465 in: *Mineral Processing and Extractive Metallurgy: 100 Years of Innovation*. Society for Mining, Metallurgy and Exploration (SME), Colorado, 2014.
- S5 Schubauer-Berigan, M.K., R.D. Daniels and L.E. Pinkerton. Radon exposure and mortality among white and American Indian uranium miners: an update of the Colorado Plateau cohort. *Am J Epidemiol* 169(6): 718-730 (2009).
- S6 Scientific Advisory Committee on Veterans' Health. Depleted uranium and Canadian veterans - a review of potential exposure and health effects. Ministry of Veterans Affairs, Ottawa, 2013.
- S7 Seiler, R.L. Temporal changes in water quality at a childhood leukemia cluster. *Ground Water* 42(3): 446-455 (2004).
- S8 Selden, A.I., C. Lundholm, B. Edlund et al. Nephrotoxicity of uranium in drinking water from private drilled wells. *Environ Res* 109(4): 486-494 (2009).
- S9 Shaki, F., M.J. Hosseini, M. Ghazi-Khansari et al. Toxicity of depleted uranium on isolated rat kidney mitochondria. *Biochim Biophys Acta* 1820(12): 1940-1950 (2012).
- S10 Shawky, S., H.A. Amer, M.I. Hussein et al. Uranium bioassay and radioactive dust measurements at some uranium processing sites in Egypt--health effects. *J Environ Monit* 4(4): 588-591 (2002).
- S11 Shenoy, N.S., A. Verma, S.A. Kumar et al. A comparative analysis of uranium in potable waters using laser fluorimetry and ICPMS techniques. *J Radioanal Nucl Chem* 294(3): 413-417 (2012).
- S12 Shim, C.K., Y. Sawada, T. Iga et al. Estimation of renal secretory function for organic cations by endogenous N1-methylnicotinamide in rats with experimental renal failure. *J Pharmacokin Biopharm* 12(1): 23-42 (1984).
- S13 Shim, W.S., J.H. Park, S.J. Ahn et al. Testosterone-independent down-regulation of Oct2 in the kidney medulla from a uranyl nitrate-induced rat model of acute renal failure: effects on distribution of a model organic cation, tetraethylammonium. *J Pharm Sci* 98(2): 739-747 (2009).
- S14 Shiquan, S., Z. Sizhong and Y. Zhanyun. Pathological studies of uranium compound intoxication. *Nucl Prot* 3: 1-54 (1976). (Chinese).
- S15 Shleien, B., L.A. Slaback Jr. and B.K. Birky. *Handbook of Health Physics and Radiological Health*. Third edition. Lippincott Williams & Wilkins, Baltimore, Maryland, 1998.
- S16 Shude, L. Evaluation of uranium burden of a case with soluble uranium compound overdose intake. *Nucl Prot* 3: 71-81 (1976). (Chinese).
- S17 Sikov, M.R. and D.D. Mahlum. Cross-placental transfer of selected actinides in the rat. *Health Phys* 14(3): 205-208 (1968).
- S18 Silva Filho, C.A., E.J. França, E.M. Souza et al. Radioactive risk evaluation of mineral water in the Metropolitan Region of Recife, Northeastern Brazil. *J Radioanal Nucl Chem* 295(2): 1215-1220 (2013).
- S19 Silver, S.R., S.J. Bertke, M.J. Hein et al. Mortality and ionising radiation exposures among workers employed at the Fernald Feed Materials Production Center (1951-1985). *Occup Environ Med* 70(7): 453-463 (2013).

- S20 Simon, O., E. Mottin, B. Geffroy et al. Effects of dietary uranium on reproductive endpoints--fecundity, survival, reproductive success--of the fish *Danio rerio*. *Environ Toxicol Chem* 30(1): 220-225 (2011).
- S21 Simon, S.L., F.O. Hoffman and E. Hofer. The two-dimensional Monte Carlo: a new methodologic paradigm for dose reconstruction for epidemiological studies. *Radiat Res* 183(1): 27-41 (2015).
- S22 Singh, J., L. Singh and S. Kher. A comparison of fission track and laser fluorometry techniques for uranium analysis in water samples. *Radiat Meas* 36(1-6): 517-519 (2003).
- S23 Singh, J., H. Singh, S. Singh et al. Estimation of uranium and radon concentration in some drinking water samples of Upper Siwaliks, India. *Environ Monit Assess* 154(1-4): 15-22 (2009).
- S24 Singh, N.P., D.B. Bennett and M.E. Wrenn. Macro-distribution of naturally occurring alpha-emitting isotopes of U in the human skeleton. *Health Phys* 52(6): 769-773 (1987).
- S25 Singh, N.P. Thorium, uranium and plutonium in human tissues of world-wide general population. *J Radioanal Nucl Chem* 138(2): 347-364 (1990).
- S26 Singh, N.P., D.P. Burleigh, H.M. Ruth et al. Daily U intake in Utah residents from food and drinking water. *Health Phys* 59(3): 333-337 (1990).
- S27 Singh, S., R. Malhotra, J. Kumar et al. Uranium analysis of geological samples, water and plants from Kulu area, Himachal Pradesh, India. *Radiat Meas* 34(1-6): 427-431 (2001).
- S28 Skipperud, L., G. Strømman, M. Yunusov et al. Environmental impact assessment of radionuclide and metal contamination at the former U sites Taboshar and Digmai, Tajikistan. *J Environ Radioact* 123: 50-62 (2013).
- S29 Souidi, M., Y. Gueguen, C. Linard et al. In vivo effects of chronic contamination with depleted uranium on CYP3A and associated nuclear receptors PXR and CAR in the rat. *Toxicology* 214(1-2): 113-122 (2005).
- S30 Spencer, H., D. Osis, I.M. Fisenne et al. Measured intake and excretion patterns of naturally occurring  $^{234}\text{U}$ ,  $^{238}\text{U}$ , and calcium in humans. *Radiat Res* 124(1): 90-95 (1990).
- S31 Squibb, K.S., R.W. Leggett and M.A. McDiarmid. Prediction of renal concentrations of depleted uranium and radiation dose in Gulf War veterans with embedded shrapnel. *Health Phys* 89(3): 267-273 (2005).
- S32 Squibb, K.S. and M.A. McDiarmid. Depleted uranium exposure and health effects in Gulf War veterans. *Philos Trans R Soc Lond B Biol Sci* 361(1468): 639-648 (2006).
- S33 Stalder, E., A. Blanc, M. Haldimann et al. Occurrence of uranium in Swiss drinking water. *Chemosphere* 86(6): 672-679 (2012).
- S34 Stearns, D.M., M. Yazzie, A.S. Bradley et al. Uranyl acetate induces hprt mutations and uranium-DNA adducts in Chinese hamster ovary EM9 cells. *Mutagenesis* 20(6): 417-423 (2005).
- S35 Stokinger, H.E., L.T. Steadman, H.B. Wilson et al. Lobar deposition and retention of inhaled insoluble particulates. *AMA Arch Ind Hyg Occup Med* 4(4): 346-353 (1951).
- S36 Storm, H.H., H.O. Jorgensen, A.M. Kejs et al. Depleted uranium and cancer in Danish Balkan veterans deployed 1992-2001. *Eur J Cancer* 42(14): 2355-2358 (2006).
- S37 Stradling, G.N., H. Smith, J.R. Cooper et al. Factors affecting the abundance of uranium isotopes in body tissues and excreta following the deposition of enriched uranium dioxide in the lungs. The radiological implications. *Health Phys* 46(2): 434-438 (1984).
- S38 Stradling, G.N., J.W. Stather, J.C. Strong et al. Metabolism of some industrial uranium tetrafluorides after deposition in the rat lung. *Hum Toxicol* 4(2): 159-168 (1985).



- S39 Stradling, G.N., J.W. Stather, S.A. Gray et al. Metabolism of uranium in the rat after inhalation of two industrial forms of ore concentrate: the implications for occupational exposure. *Hum Toxicol* 6(5): 385-393 (1987).
- S40 Stradling, G.N., J.W. Stather, S.A. Gray et al. The metabolism of ceramic and non-ceramic forms of uranium dioxide after deposition in the rat lung. *Hum Toxicol* 7(2): 133-139 (1988).
- S41 Stradling, N., A. Hodgson, E. Ansoborlo et al. Anomalies between radiological and chemical limits for uranium after inhalation by workers and the public. *Radiat Prot Dosim* 105(1-4): 175-178 (2003).
- S42 Strand, L.A., J.I. Martinsen and E.K. Borud. Cancer risk and all-cause mortality among Norwegian military United Nations peacekeepers deployed to Kosovo between 1999 and 2011. *Cancer Epidemiol* 38(4): 364-368 (2014).
- S43 Strok, M. and B. Smodis. Transfer of natural radionuclides from hay and silage to cow's milk in the vicinity of a former uranium mine. *J Environ Radioact* 110: 64-68 (2012).
- S44 Sughis, M., T.S. Nawrot, A. Riaz et al. Metal exposure in schoolchildren and working children. A urinary biomonitoring study from Lahore, Pakistan. *Int J Hyg Environ Health* 217(6): 669-677 (2014).
- S45 Sullivan, M.F. Absorption of actinide elements from the gastrointestinal tract of neonatal animals. *Health Phys* 38(2): 173-185 (1980).
- S46 Sullivan, M.F. Absorption of actinide elements from the gastrointestinal tract of rats, guinea pigs and dogs. *Health Phys* 38(2): 159-171 (1980).
- S47 Sullivan, M.F. and L.S. Gorham. Further studies on the absorption of actinide elements from the gastrointestinal tract of neonatal animals. *Health Phys* 43(4): 509-519 (1982).
- S48 Sumanovic-Glamuzina, D., V. Saraga-Karacic, Z. Roncevic et al. Incidence of major congenital malformations in a region of Bosnia and Herzegovina allegedly polluted with depleted uranium. *Croat Med J* 44(5): 579-584 (2003).
- S49 Suquin, L., L. Aiyun and R. Xue. A 33-year medical follow-up to patient with acute uranyl nitrate hexahydrate poisoning. *Radiat Prot Bull* 29(1): 18-25 (2009). (Chinese).
- S50 Swanson, S.M. Food-chain transfer of U-series radionuclides in a northern Saskatchewan aquatic system. *Health Phys* 49(5): 747-770 (1985).
- T1 Tadmor, J. Atmospheric release of volatilized species of radioelements from coal-fired plants. *Health Phys* 50(2): 270-273 (1986).
- T2 Tan, K. and S.K. Sethi. Biomarkers in cardiorenal syndromes. *Transl Res* 164(2): 122-134 (2014).
- T3 Tasat, D.R., N.S. Orona, P.M. Mandalunis et al. Ultrastructural and metabolic changes in osteoblasts exposed to uranyl nitrate. *Arch Toxicol* 81(5): 319-326 (2007).
- T4 Taulan, M., F. Paquet, C. Maubert et al. Renal toxicogenomic response to chronic uranyl nitrate insult in mice. *Environ Health Perspect* 112(16): 1628-1635 (2004).
- T5 Taulan, M., F. Paquet, A. Argiles et al. Comprehensive analysis of the renal transcriptional response to acute uranyl nitrate exposure. *BMC Genomics* 7: 2 (2006).
- T6 Thiebault, C., M. Carriere, S. Milgram et al. Uranium induces apoptosis and is genotoxic to normal rat kidney (NRK-52E) proximal cells. *Toxicol Sci* 98(2): 479-487 (2007).
- T7 Thind, K.S. A comparison of ICRP Publication 30 lung model-based predictions with measured bioassay data for airborne natural UO<sub>2</sub> exposure. *Health Phys* 53(1): 59-66 (1987).
- T8 Thorne, M.C. Estimation of animal transfer factors for radioactive isotopes of iodine, technetium, selenium and uranium. *J Environ Radioact* 70(1-2): 3-20 (2003).

- T9 Thorne, M.C. and J. Wilson. Generally applicable limits on intakes of uranium based on its chemical toxicity and the radiological significance of intakes at those limits. *J Radiol Prot* 35(4): 743-762 (2015).
- T10 Tirmarche, M., D. Laurier, F. Bochicchio et al. Final scientific report of the Alpha Risk Project funded by the European Commission EC FP6. FI6R-CT-2005-516483. European Commission Brussels, 2010.
- T11 Tissandie, E., Y. Gueguen, J.M. Lobaccaro et al. In vivo effects of chronic contamination with depleted uranium on vitamin D3 metabolism in rat. *Biochim Biophys Acta* 1770(2): 266-72 (2007).
- T12 Tissandie, E., Y. Gueguen, J.M. Lobaccaro et al. Enriched uranium affects the expression of vitamin D receptor and retinoid X receptor in rat kidney. *J Steroid Biochem Mol Biol* 110(3-5): 263-268 (2008).
- T13 Tomasek, L. and I. Malatova. Leukaemia and lymphoma among Czech uranium miners. *Medical Radiology and Radiation Safety* 51(5): 74-79 (2006).
- T14 Tomita, J., H. Satake, T. Fukuyama et al. Radium geochemistry in Na-Cl type groundwater in Niigata Prefecture, Japan. *J Environ Radioact* 101(3): 201-210 (2010).
- T15 Tournier, B.B., S. Frelon, E. Tournalias et al. Role of the olfactory receptor neurons in the direct transport of inhaled uranium to the rat brain. *Toxicol Lett* 190(1): 66-73 (2009).
- T16 Traber, S.C., V. Hollriegl, W.B. Li et al. Estimating the absorption of soil-derived uranium in humans. *Environ Sci Technol* 48(24): 14721-14727 (2014).
- T17 Tracy, B.L. and F.A. Prantl. Radiological impact of coal-fired power generation. *J Environ Radioact* 2: 145-160 (1985).
- T18 Tracy, B.L. and D.P. Meyerhof. Uranium concentrations in air near a Canadian uranium refinery. *Atmos Environ, Part A: General Topics* 21(1): 165-172 (1987).
- T19 Tracy, B.L., J.M. Quinn, J. Lahey et al. Absorption and retention of uranium from drinking water by rats and rabbits. *Health Phys* 62(1): 65-73 (1992).
- T20 Trelenberg, T.W., S.C. Glade, J.G. Tobin et al. The production and oxidation of uranium nanoparticles produced via pulsed laser ablation. *Surf Sci* 600(11): 2338-2348 (2006).
- T21 Triapitsyna, G.A., S.S. Andreev, D.I. Osipov et al. Assessment of radiation exposure level for hydrobionts in some special industrial ponds at the "Mayak" PA. *Radiats Biol Radioecol* 52(2): 207-214 (2012). (Russian).
- T22 Turtiainen, T., M. Muikku, P. Vesterbacka et al. Uranium and <sup>226</sup>Ra in drinking water supplied by Finnish waterworks. *Radioprotection* 46(06): S255-S263 (2011).
- T23 Tymen, H., P. Gerasimo and D. Hoffschir. Contamination and decontamination of rat and human skin with plutonium and uranium, studied with a Franz's chamber. *Int J Radiat Biol* 76(10): 1417-1424 (2000).
- U1 Ubios, A.M., M.B. Guglielmotti, T. Steimetz et al. Uranium inhibits bone formation in physiologic alveolar bone modeling and remodeling. *Environ Res* 54(1): 17-23 (1991).
- U2 Ubios, A.M., M. Marzorati and R.L. Cabrini. Skin alterations induced by long-term exposure to uranium and their effect on permeability. *Health Phys* 72(5): 713-715 (1997).
- U3 UNEP. Post-conflict environmental assessment - FYR of Macedonia. United Nations Environment Programme, Geneva, 2000.
- U4 UNEP. Depleted uranium in Kosovo. Post-conflict environmental assessment. United Nations Environment Programme, Geneva, 2001.
- U5 UNEP. Depleted uranium in Bosnia and Herzegovina. Post-conflict environmental assessment. Revised edition: May 2003. United Nations Environment Programme, Geneva, 2003.

- U6 UNEP. Assessment of environmental “hot spots” in Iraq. United Nations Environment Programme, Geneva, 2005.
- U7 UNSCEAR. Sources and Effects of Ionizing Radiation. UNSCEAR 1977 Report. United Nations Scientific Committee on the Effects of Atomic Radiation, 1977 Report to the General Assembly, with annexes. United Nations sales publication E.77.IX.1. United Nations, New York, 1977.
- U8 UNSCEAR. Sources and Effects of Ionizing Radiation. Volume II: Effects. UNSCEAR 2000 Report. United Nations Scientific Committee on the Effects of Atomic Radiation, 2000 Report to the General Assembly, with scientific annexes. United Nations sales publication E.00.IX.4. United Nations, New York, 2000.
- U9 UNSCEAR. Effects of Ionizing Radiation. Volume II: Scientific Annexes C, D and E. UNSCEAR 2006 Report. United Nations Scientific Committee on the Effects of Atomic Radiation. United Nations sales publication E.09.IX.5. United Nations, New York, 2009.
- U10 UNSCEAR. Sources and Effects of Ionizing Radiation. Volume I: Sources: Report to the General Assembly, Scientific Annexes A and B. UNSCEAR 2008 Report. United Nations Scientific Committee on the Effects of Atomic Radiation. United Nations sales publication E.10.XI.3. United Nations, New York, 2010.
- U11 Unwin, C., N. Blatchley, W. Coker et al. Health of UK servicemen who served in Persian Gulf War. *Lancet* 353(9148): 169-178 (1999).
- U12 Uralbekov, B.M., B. Smodis and M. Burkitbayev. Uranium in natural waters sampled within former uranium mining sites in Kazakhstan and Kyrgyzstan. *J Radioanal Nucl Chem* 289(3): 805-810 (2011).
- U13 USEPA. Occurrence and exposure assessment for uranium in public drinking water supplies. EPA contract no. 68-03-3514. Report prepared by Wade Miller Associates, Inc. for the Office of Drinking Water, April 26. United States Environmental Protection Agency, Washington, 1990.
- U14 USEPA. Review of RSC (relative source contribution) analysis. Report prepared by Wade Miller Associates, Inc., 9 May 1991 (follow-up to USEPA 1990). United States Environmental Protection Agency, Washington, D.C., 1991.
- U15 USEPA. Child-specific exposure factors handbook. Office of Research and Development, U.S. Environmental Protection Agency, Washington, D.C., 2002.
- U16 USEPA. Uranium (natural and soluble salts). Integrated Risk Information System (IRIS), United States Environmental Protection Agency, Washington, D.C., 2007.
- U17 USEPA. Drinking water regulations and contaminants - National primary drinking water regulations (NPDWRs). EPA 816-F-09-0004. United States Environmental Protection Agency, Washington, D.C., 2009.
- U18 USTUR. United States Transuranium and Uranium Registries: Annual report April 1, 2012 - March 31, 2014 (S.L. McComish and S.Y. Tolmachev, eds.). USTUR-0382-15. College of Pharmacy, Washington State University, Richland, WA, 2015.
- V1 Vacquier, B., S. Caer, A. Rogel et al. Mortality risk in the French cohort of uranium miners: extended follow-up 1946-1999. *Occup Environ Med* 65(9): 597-604 (2008).
- V2 Vacquier, B., E. Rage, K. Leuraud et al. The influence of multiple types of occupational exposure to radon, gamma rays and long-lived radionuclides on mortality risk in the French "post-55" sub-cohort of uranium miners: 1956-1999. *Radiat Res* 176(6): 796-806 (2011).
- V3 Vengosh, A., D. Hirschfeld, D. Vinson et al. High naturally occurring radioactivity in fossil groundwater from the middle east. *Environ Sci Technol* 43(6): 41769-41775 (2009).

- V4 Vesterbacka, P., I. Mäkeläinen and H. Arvela. Natural radioactivity in drinking water in private wells in Finland. *Radiat Prot Dosim* 113(2): 223-232 (2005).
- V5 Vicente-Vicente, L., Y. Quiros, F. Perez-Barriocanal et al. Nephrotoxicity of uranium: pathophysiological, diagnostic and therapeutic perspectives. *Toxicol Sci* 118(2): 324-347 (2010).
- V6 Vich, Z. and J. Kriklava. Erythrocytes of uranium miners: the red blood picture. *Br J Ind Med* 27(1): 83-85 (1970).
- V7 Vidaud, C., A. Dedieu, C. Basset et al. Screening of human serum proteins for uranium binding. *Chem Res Toxicol* 18(6): 946-953 (2005).
- V8 Vidaud, C., S. Gourion-Arsiquaud, F. Rollin-Genetet et al. Structural consequences of binding of  $UO_2(2+)$  to apotransferrin: can this protein account for entry of uranium into human cells? *Biochemistry* 46(8): 2215-2226 (2007).
- W1 Wade-Gueye, N.M., O. Delissen, P. Gourmelon et al. Chronic exposure to natural uranium via drinking water affects bone in growing rats. *Biochim Biophys Acta* 1820(7): 1121-1127 (2012).
- W2 Wagner, S.E., J.B. Burch, M. Bottai et al. Hypertension and hematologic parameters in a community near a uranium processing facility. *Environ Res* 110(8): 786-797 (2010).
- W3 Walinder, G. Metabolism and sites of effects of uranium after incorporation along different routes in mice, rabbits and piglets. *Radiat Prot Dosim* 26(1-4): 89-95 (1989).
- W4 Wallner, G., R. Wagner and C. Katzlberger. Natural radionuclides in Austrian mineral water and their sequential measurement by fast methods. *J Environ Radioact* 99(7): 1090-1094 (2008).
- W5 Wallner, G. and T. Jabbar. Natural radionuclides in Austrian bottled mineral waters. *J Radioanal Nucl Chem* 286(2): 329-334 (2010).
- W6 Walsh, L., F. Dufey, A. Tschense et al. Prostate cancer mortality risk in relation to working underground in the Wismut cohort study of German uranium miners, 1970-2003. *BMJ Open* 2(3) (2012).
- W7 Walsh, M., G. Wallner and P. Jennings. Radioactivity in drinking water supplies in western australia. *J Environ Radioact* 130: 56-62 (2014).
- W8 Wan, B., J.T. Fleming, T.W. Schultz et al. In vitro immune toxicity of depleted uranium: effects on murine macrophages, CD4+ T cells, and gene expression profiles. *Environ Health Perspect* 114(1): 85-91 (2006).
- W9 Wappelhorst, O., I. Kuhn, H. Heidenreich et al. Transfer of selected elements from food into human milk. *Nutrition* 18(4): 316-322 (2002).
- W10 Weiner, R.E., J.F. McInroy and A.V. Wegst. Determination of environmental levels of Pu, Am, U and Th in human fetal tissue. Thirtieth annual meeting of the Health Physics Society, 26-31 May 1985, Chicago, IL. *Health Phys* 49(1): 141 (1985).
- W11 Welford, G.A. and R. Baird. Uranium levels in human diet and biological materials. *Health Phys* 13(12): 1321-1324 (1967).
- W12 West, C.M. and L.M. Scott. Uranium cases showing long chest burden retention--an updating. *Health Phys* 17(6): 781-791 (1969).
- W13 WHO. Depleted uranium: sources, exposure and health effects. WHO/SDE/PHE/01.1. World Health Organization, Geneva, 2001.
- W14 WHO. Depleted uranium: sources, exposure and health effects. *J Pharm Belg* 56(3): 75-78 (2001). (French).

- W15 WHO. Uranium in drinking-water. Background document for development of WHO guidelines for drinking-water quality. WHO/SDE/WSH/03.04/118/Rev/1 (updated 2012). World Health Organization, Geneva, 2003.
- W16 WHO. Guidelines for drinking-water quality. (Vol. 1) Recommendations. Third edition. World Health Organization, Geneva, 2006.
- W17 WHO. WHO Handbook on indoor radon: A public health perspective (H. Zeeb and F. Shannoun, eds.). World Health Organization, Geneva, 2009.
- W18 WHO. Guidelines for drinking-water quality. 4<sup>th</sup> edition. World Health Organization, Geneva, 2011.
- W19 Wilson, H.B., G.E. Sylvester, S. Laskin et al. Relation of particle size of uranium dioxide dust to toxicity following inhalation by animals; II. *Arch Ind Hyg Occup Med* 6(2): 93-104 (1952).
- W20 Wilson, H.B., G.E. Sylvester, S. Laskin et al. Relation of particle size of U<sub>3</sub>O<sub>8</sub> dust to toxicity following inhalation by animals. *AMA Arch Ind Health* 11(1): 11-16 (1955).
- W21 Wilson, R., H. Jones-Otazo, S. Petrovic et al. Revisiting dust and soil ingestion rates based on hand-to-mouth transfer. *Human and Ecological Risk Assessment* 19(1): 158-188 (2013).
- W22 Wise, S.S., W.D. Thompson, A.M. Aboueissa et al. Particulate depleted uranium is cytotoxic and clastogenic to human lung cells. *Chem Res Toxicol* 20(5): 815-820 (2007).
- W23 Witmans, M.R., H.H. McDuffie, C. Karunanayake et al. An exploratory study of chemical elements in drinking water and non-Hodgkin's lymphoma. *Toxicol Environ Chem* 90(6): 1227-1247 (2008).
- W24 WNA. Processing of used nuclear fuel. World Nuclear Association. [Internet] Available from (<http://www.world-nuclear.org/info/Nuclear-Fuel-Cycle/Fuel-Recycling/Processing-of-Used-Nuclear-Fuel/>) on 6.10.2015.
- W25 Wolf, G., D. Arndt, N. Kotschy-Lang et al. Chromosomal aberrations in uranium and coal miners. *Int J Radiat Biol* 80(2): 147-153 (2004).
- W26 Wrenn, M.E., P.W. Durbin, B. Howard et al. Metabolism of ingested U and Ra. *Health Phys* 48(5): 601-633 (1985).
- W27 Wrenn, M.E., N.P. Singh, H. Ruth et al. Gastrointestinal absorption of soluble uranium from drinking water by man. *Radiat Prot Dosim* 26(1-4): 119-122 (1989).
- W28 Wünschmann, S., S. Fränze, I. Kühn et al. Transfer of selected elements from food into human milk. *Umweltwissenschaften und Schadstoff-Forschung* 16(3): 168-174 (2004). (German).
- X1 Xie, H., C. LaCerte, W.D. Thompson et al. Depleted uranium induces neoplastic transformation in human lung epithelial cells. *Chem Res Toxicol* 23(2): 373-378 (2010).
- Y1 Yao, H., R. Kidd and M. Hashino. Long-term trend of uranium concentrations in Beaverlodge Lake, Saskatchewan, Canada, under mine decommissioning. *IAHS Publication* 314: 137-144 (2007).
- Y2 Yazzie, M., S.L. Gamble, E.R. Civitello et al. Uranyl acetate causes DNA single strand breaks in vitro in the presence of ascorbate (vitamin C). *Chem Res Toxicol* 16(4): 524-530 (2003).
- Y3 Yiin, J.H., J.L. Anderson, R.D. Daniels et al. A nested case-control study of multiple myeloma risk and uranium exposure among workers at the Oak Ridge Gaseous Diffusion Plant. *Radiat Res* 171(6): 637-645 (2009).
- Y4 Yu, S.Y., H.C. Chung, E.J. Kim et al. Effects of acute renal failure induced by uranyl nitrate on the pharmacokinetics of intravenous theophylline in rats: the role of CYP2E1 induction in 1,3-dimethyluric acid formation. *J Pharm Pharmacol* 54(12): 1687-1692 (2002).

- Z1 Zablotska, L.B., R.S. Lane and S.E. Frost. Mortality (1950-1999) and cancer incidence (1969-1999) of workers in the Port Hope cohort study exposed to a unique combination of radium, uranium and gamma-ray doses. *BMJ Open* 3(2) (2013).
- Z2 Zablotska, L.B., R.S. Lane, S.E. Frost et al. Leukemia, lymphoma and multiple myeloma mortality (1950-1999) and incidence (1969-1999) in the Eldorado uranium workers cohort. *Environ Res* 130: 43-50 (2014).
- Z3 Zaire, R., C.S. Griffin, P.J. Simpson et al. Analysis of lymphocytes from uranium miners in Namibia for chromosomal damage using fluorescence in situ hybridization (FISH). *Mutat Res* 371(1-2): 109-113 (1996).
- Z4 Zaire, R., M. Notter, W. Riedel et al. Unexpected rates of chromosomal instabilities and alterations of hormone levels in Namibian uranium miners. *Radiat Res* 147(5): 579-584 (1997).
- Z5 Zamora, L.M., J.M. Zielinski, D. Meyerhof et al. Uranium gastrointestinal absorption: the fl factor in humans. *Radiat Prot Dosim* 105(1-4): 55-60 (2003).
- Z6 Zamora, M.L., B.L. Tracy, J.M. Zielinski et al. Chronic ingestion of uranium in drinking water: a study of kidney bioeffects in humans. *Toxicol Sci* 43(1): 68-77 (1998).
- Z7 Zamora, M.L., J.M. Zielinski, D.P. Meyerhof et al. Gastrointestinal absorption of uranium in humans. *Health Phys* 83(1): 35-45 (2002).
- Z8 Zamora, M.L., J.M. Zielinski, G.B. Moodie et al. Uranium in drinking water: renal effects of long-term ingestion by an aboriginal community. *Arch Environ Occup Health* 64(4): 228-241 (2009).
- Z9 Zhivin, S., D. Laurier and I. Guseva Canu. Health effects of occupational exposure to uranium: do physicochemical properties matter? *Int J Radiat Biol* 90(11): 1104-1113 (2014).
- Z10 Zhivin, S., I. Guseva Canu, E. Samson et al. Mortality (1968-2008) in a French cohort of uranium enrichment workers potentially exposed to rapidly soluble uranium compounds. *Occup Environ Med* (2015).
- Z11 Zhou, J., L. Zhou and J. Yang. Studies on effects of cytokine released from alveolar macrophage induced by mineral dust on lung fibroblast. *Zhonghua Yu Fang Yi Xue Za Zhi [Chin J Prev Med]* 32(6): 336-339 (1998). (Chinese).
- Z12 Zhou, L.R., J.H. Zhou and J.C. Yang. Effects of cytokines induced by mineral dust on lung fibroblasts in vitro. *J Occup Health* 41: 144-148 (1999).
- Z13 Zhu, G., M. Tan, Y. Li et al. Accumulation and distribution of uranium in rats after implantation with depleted uranium fragments. *J Radiat Res* 50(3): 183-192 (2009).
- Z14 Zhu, G., X. Xiang, X. Chen et al. Renal dysfunction induced by long-term exposure to depleted uranium in rats. *Arch Toxicol* 83(1): 37-46 (2009).
- Z15 Zhu, S.P., Q.Y. Hu and M.Y. Lun. Studies on reproductive toxicity induced by enriched uranium. *Zhonghua Yu Fang Yi Xue Za Zhi* 28(4): 219-222 (1994). (Chinese).
- Z16 Zhuo, W., T. Iida and X. Yang. Occurrence of <sup>222</sup>Rn, <sup>226</sup>Ra, <sup>228</sup>Ra and U in groundwater in Fujian Province, China. *J Environ Radioact* 53(1): 111-120 (2001).
- Z17 Zimmerman, K.L., D.S. Barber, M.F. Ehrich et al. Temporal clinical chemistry and microscopic renal effects following acute uranyl acetate exposure. *Toxicol Pathol* 35(7): 1000-1009 (2007).



This publication contains:

REPORT OF THE UNITED NATIONS SCIENTIFIC COMMITTEE ON THE EFFECTS  
OF ATOMIC RADIATION TO THE GENERAL ASSEMBLY

**Scientific Annexes**

Annex A. Methodology for estimating public exposures due to radioactive discharges

Annex B. Radiation exposures from electricity generation

Annex C. Biological effects of selected internal emitters—Tritium

Annex D. Biological effects of selected internal emitters—Uranium

Supplementary materials (only available online at [www.unscear.org](http://www.unscear.org))



EVALUATING RADIATION SCIENCE FOR INFORMED DECISION-MAKING

In 1955 the United Nations General Assembly established the Scientific Committee on the Effects of Atomic Radiation (UNSCEAR) in response to concerns about the effects of ionizing radiation on human health and the environment. At that time fallout from atmospheric nuclear weapons tests was reaching people through air, water and food. UNSCEAR was to collect and evaluate information on the levels and effects of ionizing radiation. Its first reports laid the scientific grounds on which the Partial Test Ban Treaty prohibiting atmospheric nuclear weapons testing was negotiated in 1963.

Over the decades, UNSCEAR has evolved to become the world authority on the global level and effects of atomic radiation. UNSCEAR's independent and objective evaluation of the science are to provide for—but not address—informed policymaking and decision-making related to radiation risks and protection.